

City of Mentor

BID SET

Mentor Municipal Maintenance HVAC Replacement

PREPARED FOR:

The City of Mentor
8500 Civic Center Boulevard
Mentor, Ohio 44060

PREPARED BY:

Denk Associates, Inc
503 East 200th Street
Cleveland, Ohio 44119-5144

PH: (216)-531-8880
FAX: 216-531-5144

Date: April, 2026

**Approved By:
Lorne Vernon,
Director of Public Works**

CITY OF MENTOR OFFICIALS

ADMINISTRATION

Kenneth J. Filipiak, City Manager

Mate Rogonjic, Finance Director

Lisa Klammer, Interim Law Director

David A. Swiger, City Engineer

Lorne Vernon, Director of Public Works

Kenneth Kaminski, Director of Parks, Recreation and Public Facilities

Kevin Malecek, Director of Economic Development and International Trade

Kathy Cantanzriti, Planning Director

Kenneth Gunsch, Chief of Police

Ron Zak, Fire Chef

COUNCIL

Janet A. Dowling, President of Council

Ray Kirchner, Vice-President of Council

Sean P. Blake, Councilperson, Ward 1

Matthew E. Donovan, Councilperson, Ward 2

Charles E. Pinkerman, Councilperson, Ward 3

John A. Krueger, Councilperson, Ward 4

Brian G. Cook, Councilperson-at-Large

Julie Schiavoni, Clerk of Council

ADVERTISEMENT FOR BIDS/PUBLIC NOTICE TO BIDDERS

Sealed proposals will be received at the Purchasing Department, City of Mentor, 8500 Civic Center Boulevard, Mentor, Ohio until 1:00 PM April 24, 2026 and will be opened and read immediately thereafter for the following project:

MENTOR MUNICIPAL MAINTENANCE HVAC REPLACEMENT

Bids must be in accordance with specifications advertised on the City of Mentor website: www.cityofmentor.com/category/rfp.

BY ORDER OF

Kenneth J. Filipiak, City Manager

Publish: *News-Herald*

APRIL 10, 2026

APRIL 17, 2026

TABLE OF CONTENTS

Title Page	i	
Officials Page	ii	
Legal Notice	LN-1	
Table of Contents	iv	
SECTION 1	<u>BID DOCUMENTS AND BID FORMS</u>	
Instructions to Bidders	IB-1 – IB-4	
Form of Non-collusion Affidavit	BF.1	
Corporate Resolution	BF.2	
Proposed Subcontractors	BF.3	
Experience Record	BF.4	
Bidder’s Insurance Agent’s Affidavit	BF.5	
Supplemental Bond Acknowledgement	BF.6	
Bid Security	BF.7	
Statement of Bidder Qualifications	BF.8 – BF.9	
RTU Schedule	BF.10	
Proposal Forms	BF.11	
Signature Page (BF.12)	SEE BELOW	
<p>ALL BIDS SUBMITTED <u>MUST INCLUDE</u> THE REQUIRED BID DOCUMENTS AND A PROPERLY EXECUTED SIGNATURE PAGE (BF.12)</p>		
<p>SIGNATURE PAGE AVAILABLE <u>ONLY</u> BY CONTACTING KYLE KASKY, KASKY@CITYOFMENTOR.COM OR 440-974-5774</p>		
SECTION 2	<u>CONTRACT FORMS</u>	
Notice of Award	CF.1	
Contract	CF.2 - CF.3	
Items to Furnish	CF.4	
Delinquent Personal Property Statement	CF.5	
Affidavit of Compliance with ORC 3517.13	CF.6	
Escrow Waiver	CF.7	
Notice to Proceed	CF.8	
Notifications	N.1	
SECTION 3	<u>GENERAL CONDITIONS, EJCDC C-700 (2007)</u>	1 - 62
SECTION 4	<u>SUPPLEMENTARY CONDITIONS</u>	SC.1 - SC.9
SECTION 5	<u>SPECIFICATIONS</u>	CS – M601
SECTION 6	<u>SPECIFIC PROJECT REQUIREMENTS</u>	SR.1
SECTION 7	<u>WAGE RATES</u>	1 - 122

SECTION 1
BID DOCUMENTS AND BID FORMS

II.

INSTRUCTIONS TO BIDDERS

The Instructions to Bidders governs, except where amended by the Specifications.

The Bidder is responsible for reading and understanding all items herein:

1. Except as otherwise provided herein, the Instructions to Bidders, Proposal-Contract Form, and all specifications, drawings and other documents referred to herein shall be a part of the contract.

2. DEFINITIONS:

- A. The term "Bidder" or "Contractor" shall mean the corporation, partnership or individual proposing or under contract to furnish the material, labor, and/or equipment listed in the Specifications.
- B. The term "City" shall mean the City of Mentor, Ohio.
- C. "Calendar Day" shall mean every day shown on the calendar.
- D. "City Manager" shall mean the Mentor City Manager or his duly authorized representative.

3. PROPOSAL: To be entitled to consideration, a proposal must be made in accordance with the following instructions:

- A. Preparation: Each proposal shall be submitted on the forms furnished by the City. All signatures shall be clearly and legibly written in long hand. No oral, facsimile or telephonic proposal or modifications will be considered. Each proposal shall show the breakdown for each item as directed on the Proposal-Contract Form. All proposals shall be considered informal which contain items not specified in the Proposal-Contract Form.

Prices for material and equipment shall include transporting and delivery to any place designated on the City's purchase order, within the corporate limits of the City. In the event of a discrepancy between unit proposal prices and extension thereof, the unit proposal price shall govern.

- B. Names of Bidders: Each proposal shall give the full business address of the Bidder(s) and be signed by them with their usual signature. Proposals by partnerships shall furnish the full names of all partners and shall be signed with the partnership name by one of the members of the partnership or by an authorized representative, followed by the signature and title of the person signing.

Proposals by corporations must be signed with the legal name of the corporation, followed by the name of the state of incorporation and by the signature and title of the President, Secretary or other person authorized to bind it in the matter.

The name of each person signing shall also be typed or printed below the signature. A proposal by a person

who affixes to their signature the word "President," "Secretary," "Agent" or other title without disclosing their principal may be held to be the proposal of the individual signing.

When requested by the City, satisfactory evidence of the authority of the officer or agent signing on behalf of a corporation or partnership shall be furnished.

- C. Delivery: The proposal shall be sealed in an envelope, addressed to:

City of Mentor
c/o Purchasing Department
8500 Civic Center Boulevard
Mentor, Ohio 44060

and delivered to the office of the Purchasing Coordinator on the date set forth in the legal advertisement. The sealed envelope shall also bear the name of the Bidder, the general item(s) proposed, and the date the proposals are to be opened. Proposals will be received until the date and time specified in the legal advertisement. Proposals will be opened and read immediately thereafter, in 2nd Floor Conference Room, Mentor Municipal Center. Proposals received after the date and time specified will be returned unopened to the Bidder.

- D. Proposal to Include All Work: Each proposal shall include all equipment, material, supplies or services described in the Instructions to Bidders, Specifications, Proposal-Contract Form and all drawings.
- E. Withdrawal of Proposal: Permission will not be given to withdraw or modify any proposal after it has been deposited as provided above. Negligence on the part of a Bidder in preparing the proposal confers no right for the withdrawal of the proposal after it has been opened.
- F. Acceptance or Rejection of Proposal: The City reserves the right to accept any proposals within sixty (60) calendar days after the same are opened, as provided above. The City reserves the right to accept any proposals which, in its opinion, are deemed to be in the best interest of the City. The City reserves the right to reject any or all proposals.

In determining the award, each item may be considered separately, and separate contracts may be awarded on the various items, unless specified to the contrary in the Specifications.

- G. Proposal Bond or Check: Each proposal must be accompanied by a cashier's or certified check, an irrevocable letter of credit, or by a proposal bond, signed by a surety company authorized to do business in the State of Ohio, in the amount of ten (10) percent of the pro-

posal and made payable to the City of Mentor, as a guarantee that the contract will be honored in the event it is awarded to the Bidder, and as a guarantee that the Bidder to whom the contract is awarded will sign all documents necessary to formalize the contract, if any.

H. Forfeiture of Check or Proposal Bond: If the Bidder to whom the contract is awarded shall fail to honor the contract, or fail to sign the documents necessary to formalize the contract, if any, the deposit accompanying the proposal shall thereupon be forfeited to the City for and as liquidated damages. The work may then be readvertised or awarded to the deemed second best Bidder as the City may determine.

I. Quantities: The quantities of the work shown on the Specifications and Proposal-Contract Form are estimated by the City and will be used as the basis for comparison of the proposals only. The City reserves the right to decrease or increase any quantities and to eliminate any item(s) on the plans or proposal.

J. Informal Proposals: Proposals may be rejected for the following reasons:

- 1) If the proposal is on a form other than that furnished by the City or if the form is altered or any part thereof detached.
- 2) If there are any unauthorized additions, conditional or alternate proposals, or other irregularities of any kind which may tend to make the proposal incomplete, indefinite or ambiguous as to its meaning.
- 3) If the Bidder adds any provisions reserving the right to accept or reject an award, or to enter into a contract pursuant to an award. This does not exclude a proposal limiting the maximum gross amount of awards acceptable to any one Bidder at any one proposal letting, provided that the City will make any selection of awards.
- 4) If the proposal does not contain a unit price for each pay item listed, except in the case of authorized alternate pay items or lump sum items.

4. A. Competency of Bidders: No proposal will be considered unless the Bidder submitting the same shall furnish evidence satisfactory to the City Manager that they have the necessary equipment, ability and financial resources to fulfill the conditions of the contract and Specifications. Previous experience and responsibility of the Bidders will be considered in awarding the contract. No contract will be awarded to any Bidder who is in arrears to the City upon debt or contract, or who is in default as surety or otherwise upon any obligation to the City.

B. Disqualification of Bidders: Any of the following reasons may be considered as being sufficient for the disqualification of a Bidder and the rejection of their proposal or proposals.

- 1) More than one proposal for the same work from an individual, firm or corporation under the same or different names.
- 2) Evidence of collusion among Bidders. Participants in such collusion will receive no recognition as Bidders for any further work of the City until any such participant shall have been reinstated as a qualified Bidder.
- 3) Proposal prices that obviously are unbalanced.

5. WRITTEN AND ORAL EXPLANATIONS: Should a Bidder find discrepancies in, or omissions from, the drawings or Specifications, or should they be in doubt as to their meaning, they shall at once notify the City, which may send written instructions to all Bidders. The City will not be responsible for any oral instructions.

6. ADDENDUM OR MODIFICATION: Any addendum or modification issued during the time of bidding shall be covered in the proposal and in awarding a contract, such addendum or modification will become part thereof. In the event any such addendum or modification is issued by the City within 72 hours of the time set for the closing of proposals, excluding Saturdays, Sundays and legal holidays, the time for submitting proposals shall be extended one (1) week, with no further advertising of proposals.

7. TAX EXEMPTIONS: The City is exempt from federal excise and transportation taxes and Ohio State sales tax. Prices quoted should not include either federal excise or Ohio State sales tax. Tax exemption certificates covering these taxes will be furnished upon request.

The transportation tax is not applicable on any purchase consigned to the City and no tax exemption certificate is required. If for any reason a contemplated purchase would not be tax exempt, this fact will be indicated in the Specifications, and such taxes may be included in the price or shown as a separate item in the proposal.

8. DISCRIMINATION: In hiring of employees for the performance of work under this contract or any subcontract, neither the Contractor, subcontractor, nor any person acting in their behalf shall by reason of race, creed, color, age, sex or handicap discriminate against any citizen of the State in the employment of any laborer or worker who is qualified and available to perform the work to which the employment relates.

Neither the Contractor, subcontractor, nor any person in their behalf shall in any manner discriminate against or intimidate any employee hired for the performance of work under this contract on account of race, creed, color, age, sex or handicap.

9. INSURANCE: If the Specifications indicate insurance is required, then the Contractor shall obtain and pay for the following types of insurance:

- (a) Commercial General Liability insurance with minimum limits of not less than \$1,000,000 combined single limit. Coverage is to include contractual liability, a per

project general aggregate limit, primary and non-contributory other insurance provision, waiver of subrogation in favor of the City and additional insured status for the City including ongoing operations and products and completed operations. If such coverage is written on a Claims Made or Claims Made and Reported basis, (i) such coverage will have a retroactive date that is equal to or that precedes the date of the contract and be maintained for a minimum period of not less than three (3) years after the termination or expiration of the contract, (ii) may be replaced with other Claims Made or Claims Made and Reported coverage with a retroactive date that is equal to or that precedes the date of the contract and maintained for a minimum period of not less than three (3) years after the termination or expiration of the contract or (iii) may be cancelled after the termination of or expiration of the contract only if it is replaced by an extended reporting period with a duration of not less than three (3) years.

- (b) Automobile Liability insurance providing coverage for all owned, non-owned and hired automobiles with minimum limits not less than \$1,000,000 combined single limit. Coverage shall include additional insured status for the City and a waiver of subrogation for the City.
- (c) Worker's Compensation which meets all statutory minimum requirements

All policies must be written with insurance companies acceptable to the City. All policies are to provide the City with thirty (30) days advanced written notice of cancellation or non-renewal with the exception of cancellation for non-payment of premium which shall be ten (10) days. Contractor shall supply certificates of insurance evidencing the required coverage and shall furnish renewal certificates thirty (30) days prior to the renewal date. Failure of the City to request certificates does not relieve the Contractor from the obligation to maintain the required insurance.

- 10. LIABILITY: The Bidder shall defend, indemnify, and save harmless the City and its officers and agents from all claims, demands, payments, suits, actions, recoveries and judgments of every description, whether or not well founded by law, brought or recovered against it, by reason of any act or omission of said Bidder(s), their agents, subcontractors or employees, in the execution of the contract, or for the use of any patented inventions by said Bidder. A sum sufficient to cover aforesaid claims, including attorneys' fees, may be retained by the City from monies due or to become due to the Bidder under contract, until such claims shall have been discharged.
- 11. ROYALTIES AND/OR LICENSE FEES: The Bidder shall pay all royalties and license fees. The Bidder herein agrees to assume and save the City, its officers and agents harmless from liability of any kind or nature whatsoever, arising out of the use by the City, its officers and agents of any item, appliance, apparatus or mechanism, material or service which may be furnished or installed by the Bidder under the terms of this contract, including patent or copyright infringement, and to defend the City from any and all such liabilities whether or not such claims are well founded by law.

- 12. ASSIGNMENT OF CONTRACT: The Bidder who is awarded a contract shall not assign, transfer, convey, sublet or otherwise dispose of said contract, or right, title or interest in or to the same, or any part thereof, without previous consent in writing from the City Manager, endorsed on or attached to the contract.
- 13. CANCELLATION: Should the material(s) supplied or delivered to the City under this contract fail at any time to meet the Specifications required by the contract, then in such event, the City may cancel this contract upon written notice to the Bidder.
- 14. CONTROL OF WORK: The City Manager, or his designated agent, will decide all questions which may arise as to the quality and acceptability of materials furnished and work performed and as to the rate of progress of the work; all questions which may arise as to the interpretation of the plans and Specifications; all questions as to the acceptable fulfillment of the contract on the part of the Contractor, and as to compensation.
- 15. CLAIMS FOR ADJUSTMENT AND DISPUTES: If, in any case, the Contractor deems that additional compensation is due for work or material not clearly covered in the contract or not ordered by the City Manager as extra work, as defined herein, the Contractor shall notify the City Manager in writing of their intention to make claim for such additional compensation before they begin the work on which the claim is based. If such notification is not given and the City Manager is not afforded proper facilities by the Contractor for keeping strict account of actual costs as required, then the Contractor hereby agrees to waive any claim for such additional compensation. Such notice by the Contractor, and the fact that the City Manager has kept account of the cost aforesaid, shall not in any way be construed as proving or substantiating the validity of the claim. If the claim, after consideration by the City Manager, is found to be just, it will be paid as extra work in the amount as approved by the City Manager.
- 16. DURATION OF CONTRACT: The duration of the contract shall be for the period stated in the Specifications, and shall include all material, equipment and/or services ordered or delivered during the period. All prices quoted shall be for a definite fixed period unless otherwise noted in the Specifications.
- 17. PURCHASES: After a contract has been signed, it shall only become operative upon delivery to the Bidder a duly signed purchase order. The City shall only be obligated under the contract to the extent of such purchase order. The City shall not become liable for any claims in the event that the total quantity of material ordered or services performed under the contract should prove to be greater or less than the estimated amount in the Specifications.
- 18. DELIVERY: The Bidder agrees to make deliveries of supplies and materials within a reasonable period from the time purchase orders are received, which reasonable time is estimated to be thirty (30) days.

If deliveries are not made within such period, then the City may purchase such items in the open market; and if the prices paid by the City shall be greater than the contract price, the Bidder agrees to reimburse the City for any loss or losses that the City may thereby sustain.

Delivery time for vehicles and equipment may be extended beyond thirty (30) days, provided the Bidder has noted the delivery time in the appropriate space on the Proposal-Contract Form.

19. PAYMENT OF INVOICES: Invoices will be due and payable within thirty (30) days of receipt of the invoice by the City. All invoices should be mailed to the attention of the Accounts Payable Department. Payments may be made on a basis of estimated partial completion of work or delivery, and the City may withhold a percentage of each partial payment until completion of the contract. The City may withhold a percentage of the final estimate for a specified period as a guarantee. Such a procedure for partial payments must be provided for in the Specifications.
20. CONTRACT BOND: The successful Bidder will be required to furnish the approved bond for the faithful performance of the contract in the amount of one hundred percent (100%) of the contract price. Such bond shall be that of an approved surety company or personal bond upon which the sureties are persons not interested in the contract, or, if interested, collateral security shall be furnished, all of which is to be to the satisfaction of the Law Director, including sureties.

In lieu of a performance bond the City may elect to hold the Proposal Deposit Check, submitted with the proposal, until the contract has been fulfilled. **Any deviation from the required one hundred percent (100%) figure will be noted in the Specifications.**
21. GENERAL: Contractors shall furnish all labor, equipment, materials, services and supplies necessary to complete the proposed work. All work shall be performed according to all standards of good workmanship complete in every detail. Contractors shall coordinate their work with the work of others and, upon completion, remove tools, equipment, waste and debris and leave the site in "broom-clean" condition. Contractors shall warrant all equipment, materials, services and supplies with the normal and usual warranties, including, where applicable, warranties of merchantability and fitness for a particular purpose.
22. WAIVERABILITY: The City of Mentor reserves the right to accept any part of any proposal and reject all or parts of any and all proposals, and waive any informalities in the bidding procedure.
23. PREVAILING WAGE: Contractors must comply with ORC Chapter 4115 when applicable. It is the Contractor's responsibility to contact the City's Prevailing Wage Coordinator to determine requirements.
24. TAXES: Contractor shall pay and/or withhold all sales, consumer, use, employment and other taxes (including the City of Mentor 2% income tax) paid or withheld by Contractor in accordance with the Laws and Regulations of the

United States, State of Ohio and City of Mentor which are applicable during the performance of the work.

QUESTIONS:

Finance:

Kyle Kasky, Staff Accountant
8500 Civic Center Blvd
Mentor Ohio, 44060
Phone (440)974-5774
Kasky@cityofmentor.com

Public Works:

Lorne Vernon, Director of Public Works
6645 Hopkins Road
Mentor Ohio, 44060
Phone (440)974-5781
Vernon@cityofmentor.com

FORM OF NONCOLLUSION AFFIDAVIT

STATE OF _____)

) SS

COUNTY OF _____)

_____, being first duly sworn, deposes and says
(Individual Name)

that he/she is _____ of _____
(Sole Owner, Partner, President, Secretary, etc.) (Corporation Name)

the party making the proposal or bid; that such bid is genuine and not collusive or sham; that said Bidder has not colluded, conspired, connived, or agreed, directly or indirectly with any Bidder or person, to put in a sham bid, or that such other person shall refrain from bidding, and has not in any manner, directly or indirectly sought by agreement or collusion or communication or conference, with any person, to fix the bid price of affiant or any other Bidder, or to fix any overhead, profit, or cost element of said Bid price, or of that of any other Bidder, or to secure any advantage against the Owner, or any person interested in the proposed Contract; and that all statements contained in said proposal or bid are true; and further, that such Bidder has not, directly or indirectly submitted this Bid, or the contents thereof, or divulged information or data relative thereto to any association or to any member or agent thereof.

Affiant

Subscribed and sworn to before me this _____ day of _____, 20_____.

Notary Public

My Commission Expires: _____

CORPORATE RESOLUTION

I, _____,
(Individual Name)

Secretary of _____ an _____ Corporation
(Corporation Name) (State)

hereby certify that the Board of Directors of said Corporation on the _____ day of _____, 20____, adopted a resolution authorizing the _____ of this
(Corporation Title, i.e., President, etc.)

Company, namely, _____, to sign bid proposals, sign and
(Individual Name)

enter into any and all contracts and other instruments, sign and/or authorize bid guaranty and performance bonds for the purpose of furnishing labor and materials at such price and upon such terms and conditions, including any amendments or modifications thereto, as said

_____ in his sole discretion shall deem best, and that said actions
(Corporation Title, i.e., President, Vice President, etc.)

shall be binding upon the Corporation.

IN WITNESS WHEREOF, I have hereunto set my hand and affixed the seal of said Corporation at _____, _____ this _____ day
(City) (State)
of _____, 20____, and I further certify that said resolution is still in full force and effect.

Corporate Secretary

PROPOSED SUBCONTRACTORS

The Bidder is required to state in the spaces provided below, the Subcontractors he proposes to use to accomplish the work under this Contract. The items and specific amounts of work assigned to each listed Subcontractor shall also be outlined. Duplicate this sheet as needed.

1. Name: _____
Address: _____
City/State/Zip: _____
Description: _____
Phone: () _____ Amount: \$ _____ % of Contract: _____

2. Name: _____
Address: _____
City/State/Zip: _____
Description: _____
Phone: () _____ Amount: \$ _____ % of Contract: _____

3. Name: _____
Address: _____
City/State/Zip: _____
Description: _____
Phone: () _____ Amount: \$ _____ % of Contract: _____

4. Name: _____
Address: _____
City/State/Zip: _____
Description: _____
Phone: () _____ Amount: \$ _____ % of Contract: _____

5. Name: _____
Address: _____
City/State/Zip: _____
Description: _____
Phone: () _____ Amount: \$ _____ % of Contract: _____

EXPERIENCE RECORD

The Bidder is required to state the character of previous work, give references, and such other detailed information as will enable the Owner to determine capability, responsibility, experience, skill, and financial standing. Provide data for the last five (5) years. Duplicate this sheet as needed. **Information submitted in an alternate format MUST contain all the information requested on this page.**

Project Name: _____
Description/Scope of Bidder's _____
On this project you were a ___ Prime Contractor **OR** ___ Sub Contractor to _____
Total Project Cost: \$ _____ Your Contract or Subcontract Amount: \$ _____
% Complete (if in progress) ___ % or Date Completed (if complete): _____
Project Owner: _____
Owner Contact: _____ Phone: () _____
Engineer/Arch. Firm: _____
Engineer/Arch. Contact: _____ Phone: () _____
Your Bonding Company on this project (if any): _____

Project Name: _____
Description/Scope of Bidder's _____
On this project you were a ___ Prime Contractor **OR** ___ Sub Contractor to _____
Total Project Cost: \$ _____ Your Contract or Subcontract Amount: \$ _____
% Complete (if in progress) ___ % or Date Completed (if complete): _____
Project Owner: _____
Owner Contact: _____ Phone: () _____
Engineer/Arch. Firm: _____
Engineer/Arch. Contact: _____ Phone: () _____
Your Bonding Company on this project (if any): _____

Project Name: _____
Description/Scope of Bidder's _____
On this project you were a ___ Prime Contractor **OR** ___ Sub Contractor to _____
Total Project Cost: \$ _____ Your Contract or Subcontract Amount: \$ _____
% Complete (if in progress) ___ % or Date Completed (if complete): _____
Project Owner: _____
Owner Contact: _____ Phone: () _____
Engineer/Arch. Firm: _____
Engineer/Arch. Contact: _____ Phone: () _____
Your Bonding Company on this project (if any): _____

SUPPLEMENTAL BOND ACKNOWLEDGEMENT

PROJECT: _____

OWNER: _____

If the bidder submits a Bid Guaranty and Contract Bond (AKA Rollover or Bid/ Performance/ Payment/ Warranty Bond) per O.R.C. Sections 153.54 and 153.571 the following shall be completed, signed, and submitted with the bid:

By submission of the attached bid and these presents, the undersigned bidder and his surety hereby acknowledge that the attached bond shall cover and warrant all work for the correction period per the General Conditions and as supplemented or amended elsewhere in these Contract Documents, which period is one year(s) commencing on the final acceptance of the work by Owner. Any proceeding, legal or equitable, under this Bond may be instituted in any court of competent jurisdiction in the location in which the project or part of the project is located and shall be instituted within one year from the last day of the correction period under the project or within one year after the Surety refuses or fails to perform its obligations under this Bond, whichever first occurs.

BIDDER

SURETY

SIGNATURE: _____	SIGNATURE: _____
NAME: _____	NAME: _____
TITLE: _____	TITLE: _____
DATE: _____	DATE: _____
PHONE NO.: _____	PHONE NO.: _____

*Attach Power of Attorney

If the Bidder submits a Certified or Cashier's check, Irrevocable Letter of Credit and is awarded a contract by the Owner, the following shall be completed, signed, and submitted with the Contract Bond (AKA Performance/Payment/Warranty Bond) per ORC Sections 153.54 and 153.57.

By signature of the attached Contract and these presents the undersigned contractor and his surety acknowledge that the attached Bond shall cover and warrant all work for the correction period per the General Conditions and as supplemented or amended elsewhere in these Contract Documents, which period is one year(s) commencing on the final acceptance of the work by Owner. Any proceeding, legal or equitable, under this Bond may be instituted in any court of competent jurisdiction in the location in which the project or part of the project is located and shall be instituted within one year from the last day of the correction period under the project or within one year after the Surety refuses or fails to perform its obligations under this Bond, whichever first occurs.

BIDDER

SURETY

SIGNATURE: _____	SIGNATURE: _____
NAME: _____	NAME: _____
TITLE: _____	TITLE: _____
DATE: _____	DATE: _____
PHONE NO.: _____	PHONE NO.: _____

*Attach Power of Attorney

BID SECURITY

**CONTRACTOR SHALL STAPLE ONE OF THE FOLLOWING FORMS
OF BID SECURITY TO THE FRONT OF THIS PAGE AND
SUBMIT WITH THE BID.**

CERTIFIED OR CASHIER'S CHECK FOR 10% OF THE AMOUNT BID

OR

IRREVOCABLE LETTER OF CREDIT FOR 10% OF THE AMOUNT BID

OR

**BOND (BID/PERFORMANCE/PAYMENT" BOND, a.k.a., "ROLLOVER BOND") FOR
100% OF THE AMOUNT BID PER ORC SECTIONS 153.54 AND 153.571**

STATEMENT OF BIDDER QUALIFICATIONS

BIDDER NAME (print/type): _____

BIDDER ADDRESS: _____

BIDDER CONTACT: _____

BIDDER PHONE NUMBER: _____

BIDDER FAX NUMBER: _____

BIDDER E-MAIL: _____

Ohio Entity Number: _____

Federal Tax Identification Number: _____

State Tax Identification Number: _____

STATEMENT OF BIDDER QUALIFICATIONS

1. Years in business providing the goods or service requested in this bid. _____
 2. Please list on a separate sheet(s), contracts with municipalities previous and presently held. Please list by community name, contact person, address, phone number, and scope of project (starting with the most recent).
 3. Is your company in satisfactory financial condition? Yes _____ No _____
 4. How many miles is your facility from the Mentor Municipal Center? _____
 5. Please list on a separate sheet(s) the equipment to be used in fulfilling this contract.
 6. Identify the project manager who will be assigned to this project and applicable years of experience managing comparable jobs.
-

For the following questions, on a separate sheet please describe in full the circumstances for any "Yes" answer.

7. Has your company had any business interruptions as a result of financial conditions in the past two (2) years? Yes _____ No _____
8. Has your company been rejected for a public contract despite being a low bidder for any reason? Yes _____ No _____
9. Has your company had any claims against or a performance bond cancelled? Yes _____ No _____
10. Has your company paid penalties or liquidated damages imposed as a result of delay on a public project? Yes _____ No _____
11. Has your company been found to have committed an unfair labor practice or any other employment/labor law violation in such areas as discrimination, prevailing wage, Workers Compensation or OSHA? Yes _____ No _____
12. Has your company in the last three (3) years had a municipal contract cancelled or terminated? Yes _____ No _____

RTU SCHEDULE					
ROOFTOP UNIT SCHEDULE					
UNIT	MAKE	MODEL	INCOMPLIANCE		PROPOSED
			YES	NO	
xACU-1		EXISTING			-
xACU-2		EXISTING			-
ACU-3	Trane	YSK150A4SOM			

BF.10

VI. PROPOSAL-CONTRACT FORM

The undersigned hereby proposes to furnish the City of Mentor, Ohio, the following items, in accordance with the specifications. and upon the terms and conditions of this proposal, providing this proposal or any part hereof is accepted as a contract by the City of Mentor.

ITEM NO.	<u>DESCRIPTION</u>	<u>TOTAL PRICE</u>
1.	MENTOR MUNICIPAL MAINTENANCE HVAC REPLACEMENT	\$ _____
2.	TEMPERATURE CONTROL INCLUDING SOFTWARE AND HARDWARE IS INCLUDED IN ITEM #1 TOTAL PRICE ABOVE AS SPECIFIED. IF NOT, THE CONTRACTOR SHALL INCLUDE THE PROPOSED MANUFACTURER/INSTALLER AND THE ASSOCIATED PRICE ADDITION OR PRICE DEDUCTION IN ITEM 1. PROPOSED MANUFACTURER: _____ ADD/DEDUCT \$ _____	

The Bidder hereby acknowledges receipt of following addenda:

Addendum No.	_____	_____	_____	_____
Date:	_____	_____	_____	_____

CONDITIONS: The Instructions to Bidders, and the Specifications are a part of this contract as effectively as though they preceded the signatures of the parties. This contract is not valid until accepted and signed by the City of Mentor.

THIS PAGE HAS BEEN INTENTIONAL OMITTED IN ATTEMPT TO KEEP RECORD OF A PLANHOLDERS LIST.

CONTRACT (BF.12) AVAILABLE ONLY BY CONTACTING KYLE KASKY AT KASKY@CITYOFMENTOR.COM OR (440)974-5774

SECTION 2
CONTRACT FORMS

NOTICE OF AWARD

TO: <CONTRACTOR>

PROJECT: <PROJECT NAME>

You are notified that your Bid which was opened on <BID OPENING DATE> has been accepted for items in the amount of <AWARD AMOUNT> at the unit bid prices as reflected in the bid tabulation contained herein for Base Bid and Alternates.

You are required by the Instructions to Bidders to execute the Agreement and furnish the required Bonds, Certificates of Insurance, and other documents within 10 calendar days from the date of receipt of this Notice.

Failure to comply with these conditions within the time specified will entitle Owner to consider your Bid in default, to annul this Notice and to declare your Bid Security forfeited.

The Owner will return to you one (1) fully signed set of the contract documents.

CITY OF MENTOR

Kenneth J. Filipiak, City Manager

Date

ACKNOWLEDGMENT

<CONTRACTOR>

<SIGNATORY>

Date

CONTRACT

<PROJECT NAME>

THIS AGREEMENT, made and entered into at Mentor, Ohio, this _____ day of _____, <YEAR>, by and between the City of Mentor (“OWNER”), Ohio and <CONTRACTOR> (“CONTRACTOR”).

WITNESSETH: That the said CONTRACTOR has agreed and by this presents does agree with the OWNER for the consideration hereinafter mentioned and contained, and under penalty expressed in a bond given with these presents, and herein contained or hereunto annexed, to furnish at its own cost and expense, all the necessary tools, equipment, materials, labor, and tests in an expeditious, substantial and workmanlike manner, the equipment and appurtenances herein contemplated, commencing work within 20 days from the date of the Notice to Proceed and executing the work within the time and in the manner specified and in conformity with the requirements set forth in this Contract.

The following form essential parts of the Contract (may vary with project).

1. Advertisement for Bids/Public Notice to Bidders
2. Instruction to Bidders
3. Bid Forms and Proposal
4. Contract Forms and Exhibits
5. Contract Bond – ORC 153.571 or ORC 153.57
6. Contract Provisions
7. General Conditions
8. Supplementary Conditions
9. Specifications
10. Specific Project Requirements
11. Prevailing Wage Rate Schedule
12. Contract Drawings; if any.

The CONTRACTOR agrees and understands that the work on this contract shall be subject to the acceptance of the OWNER based upon and in accordance with the contract specifications and contract plans and drawings on file in the office of the OWNER.

The Contractor agrees that each individual employed by the Contractor or any Subcontractor and engaged in work on the project under this contract shall be paid by prevailing wage established by the Department of Industrial Relations of the State of Ohio or the U.S. Department of Labor (Davis-Bacon Act) as detailed in the section titled "Wage Rates." This shall occur regardless of any contractual relationship which may be said to exist between the Contractor or any Subcontractor and such individual.

The CONTRACTOR shall proceed with the said work in a prompt and diligent manner and shall do the several parts thereof. Further he shall complete the whole of said work in accordance with the specifications and contract drawings to the satisfaction of the OWNER on or before the time stated, and in default of completion within the time as fixed, the CONTRACTOR shall pay to the OWNER as liquidated damages, an amount equal to <LIQUIDATED DAMAGES AMOUNT> Per Day, for each and every day (Sundays and legal holidays excepted) the completion of the work may be delayed beyond the date fixed in the manner and as stipulated.

It is hereby mutually agreed that the OWNER is to pay and the CONTRACTOR is to receive, as full compensation for design and furnishing all materials and labor in building, constructing and testing and in all

respect completing the herein described work and appurtenances in the manner and under the conditions herein specified, the prices stipulated in the proposal herein contained or hereto annexed and the total contract sum is **<AMOUNT>**.

This Contract shall be in full force and effect from the date of execution by the parties.

IN WITNESS WHEREOF: The parties hereunto affixed their signature the day and year first mentioned above.

<CONTRACTOR>

<SIGNATORY>

CITY OF MENTOR

Kenneth J. Filipiak, City Manager

I hereby certify that funds in the amount of **<AMOUNT IN WORDS>** 00/100 Dollars (**<AMOUNT>**) necessary for the foregoing Contract have been appropriated and are in the Treasury, or are in the process of collection, or are available through grants and/or loans from other funding sources.

Mate Rogonjic, Finance Director

APPROVED AS TO FORM:

Joseph P. Szeman, Law Director

**THE CONTRACTOR SHALL FURNISH THE FOLLOWING ITEMS
WITHIN 10 DAYS OF NOTIFICATION OF AWARD:**

- A) **CERTIFICATE OF INSURANCE FOR
CONTRACTOR'S PUBLIC LIABILITY INSURANCE POLICY
AND AUTOMOTIVE INSURANCE POLICE**
- B) **CERTIFICATE OF INSURANCE FOR
OWNER'S AND CONTRACTOR'S PROTECTIVE POLICY**
- C) **CERTIFICATE OF WORKER'S COMPENSATION**
- D) **CONTRACT BOND THAT COMPLIES WITH ORC 153.54 AND 153.57**
Submitted bond complying with ORC 153.54 and 153.571 (rollover bond) with Bid
- * D above is not required if a bond complying with ORC 153.54 and 153.571 (rollover bond) was submitted at time of bid.
- E) **DRUG-FREE SAFETY OR COMPARABLE PROGRAM**

DELINQUENT PERSONAL PROPERTY STATEMENT

<CONTRACTOR>, having been awarded a contract by the City of Mentor, Ohio, hereby affirms under oath, pursuant to Ohio Revised Code Section 5719.042, that at the time the bid was submitted, my company **was / was not (CIRCLE ONE)** charged with delinquent personal property taxes on the General Tax List of Personal Property for Lake County, Ohio.

If such charge for delinquent personal property tax exists on the General Tax List of Personal Property for Lake County, Ohio, the amount of such due and unpaid delinquent taxes, including due and unpaid penalties and interest shall be set forth below.

This statement will be incorporated into the Contract made between City of Mentor, Ohio, and <CONTRACTOR>, and no payment shall be made with respect to any Contract unless such statement has been so incorporated as a part thereof.

Delinquent Personal Property Tax	\$ _____
Penalties	\$ _____
Interest	\$ _____

<CONTRACTOR>

<SIGNATORY>

SWORN TO BEFORE ME and subscribed in my presence this _____ day of

_____, <YEAR>.

Notary Public

My commission expires: _____

**AFFIDAVIT
OF COMPLIANCE WITH OHIO REVISED CODE SECTION 3517.13**

STATE OF OHIO

COUNTY OF _____

_____ being duly sworn deposes and states as follows:

1. I am duly authorized to make the statements contained herein on behalf of _____ (“the Contracting Party”).
2. The Contracting Party is a/an (select one):
 - Individual, partnership, or other unincorporated business association (including without limitation, a professional association organized under Ohio Revised Code Chapter 1787), estate, or trust
 - Corporation organized and existing under the laws of the State of _____
 - Labor organization
3. I hereby affirm that the Contracting Party and each of the individuals specified in R.C. 3517.13(I) (with respect to non-corporate entities and labor organizations) or R.C. 3517.13(J) (with respect to corporations) are in full compliance with the political contribution limitations set forth in R.C. 3517.13(I) and (J), as applicable.
4. I understand that a false representation on this certification will incur penalties pursuant to 3517.992(R)(3).

Affiant further sayeth naught.

By: _____

Title: _____

SWORN TO BEFORE ME and subscribed in my presence this _____ day of

_____, **<YEAR>**.

Notary Public

My commission expires: _____

ESCROW WAIVER

In accordance with a certain Contract between the CITY OF MENTOR, MENTOR, OHIO, (hereinafter referred to as "the Owner") and <CONTRACTOR>, (hereinafter referred to as "the Contractor") it is mutually agreed by and between the parties hereto that because of the short-term duration of the within contract, no escrow account will be established pursuant to Sections 153.13, 153.14 and 153.63 of the Ohio Revised Code nor shall any interest be paid on any retainage.

<CONTRACTOR>

<SIGNATORY>

CITY OF MENTOR

Kenneth J. Filipiak, City Manager

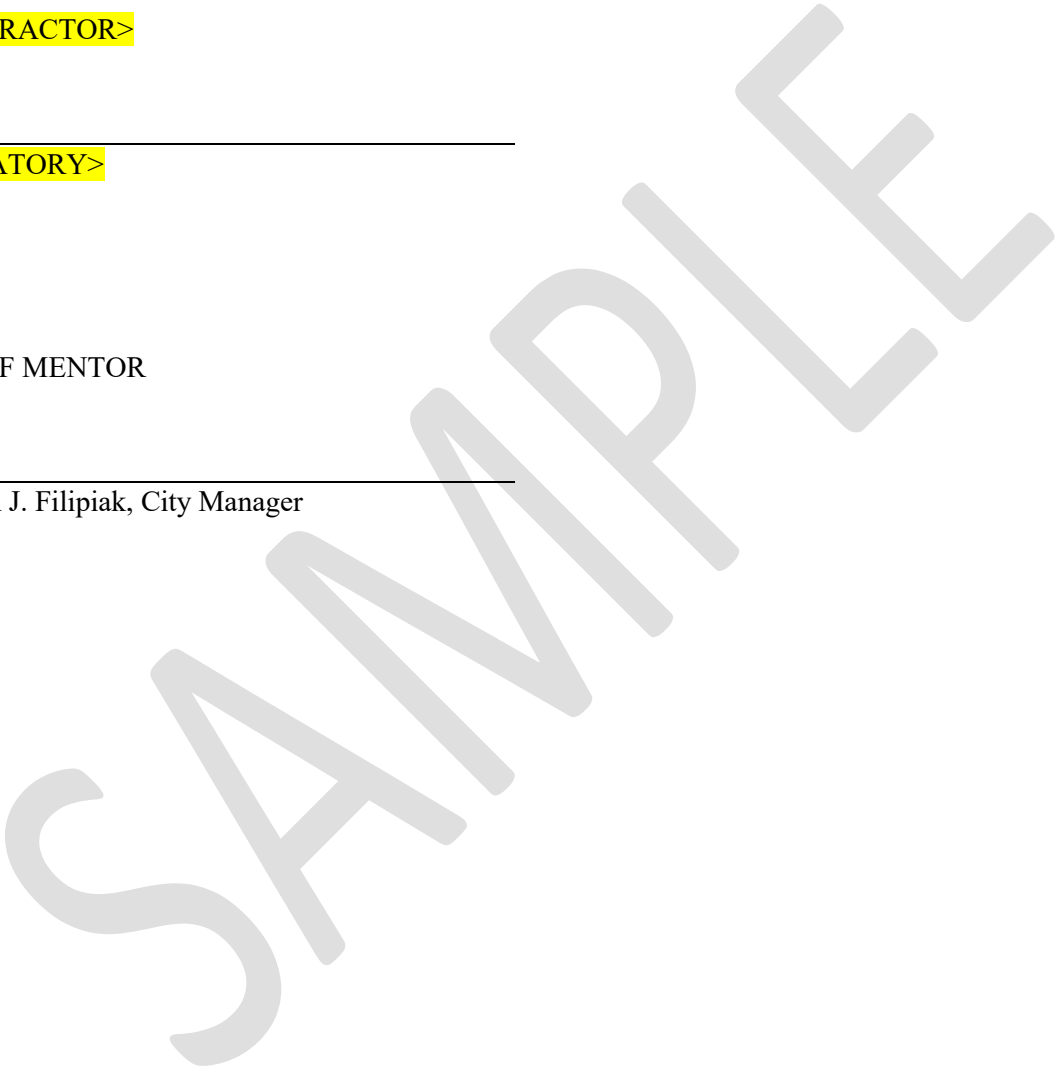

NOTICE TO PROCEED

Project: <PROJECT NAME>

Owner: City of Mentor
8500 Civic Center Boulevard
Mentor, Ohio 44060

To: <CONTRACTOR>

Date: _____

You are hereby notified to commence work in accordance with the Contract. All work shall be completed by <COMPLETION DATE>.

CITY OF MENTOR

Kenneth J. Filipiak, City Manager

**CONTRACTOR SHALL COMPLETE THE FOLLOWING AND RETURN
WITHIN 10 DAYS OF NOTICE OF AWARD:**

**A) AFFIDAVIT OF COMPLIANCE WITH POLITICAL CONTRIBUTIONS
LIMITATION (ORC 3517.13)**

**THE OWNER OR THEIR AUTHORIZED REPRESENTATIVE SHALL INSERT
THE FOLLOWING CONTRACT DOCUMENTATION IN THE EXECUTED
CONTRACT:**

A) FINDINGS FOR RECOVERY – ORC 9.24

**B) NOTIFICATION OF SURETY AND AGENT OF CONSTRUCTION
CONTRACT AWARD – ORC 9.32 (if applicable)**

SECTION 3
GENERAL CONDITIONS

This document has important legal consequences; consultation with an attorney is encouraged with respect to its use or modification. This document should be adapted to the particular circumstances of the contemplated Project and the controlling Laws and Regulations.

STANDARD GENERAL CONDITIONS OF THE CONSTRUCTION CONTRACT

Prepared by

ENGINEERS JOINT CONTRACT DOCUMENTS COMMITTEE

and

Issued and Published Jointly by



AMERICAN COUNCIL OF ENGINEERING COMPANIES

ASSOCIATED GENERAL CONTRACTORS OF AMERICA

AMERICAN SOCIETY OF CIVIL ENGINEERS

PROFESSIONAL ENGINEERS IN PRIVATE PRACTICE
A Practice Division of the
NATIONAL SOCIETY OF PROFESSIONAL ENGINEERS

Endorsed by



CONSTRUCTION SPECIFICATIONS INSTITUTE

These General Conditions have been prepared for use with the Suggested Forms of Agreement Between Owner and Contractor (EJCDC C-520 or C-525, 2007 Editions). Their provisions are interrelated and a change in one may necessitate a change in the other. Comments concerning their usage are contained in the Narrative Guide to the EJCDC Construction Documents (EJCDC C-001, 2007 Edition). For guidance in the preparation of Supplementary Conditions, see Guide to the Preparation of Supplementary Conditions (EJCDC C-800, 2007 Edition).

Copyright © 2007 National Society of Professional Engineers
1420 King Street, Alexandria, VA 22314-2794
(703) 684-2882
www.nspe.org

American Council of Engineering Companies
1015 15th Street N.W., Washington, DC 20005
(202) 347-7474
www.acec.org

American Society of Civil Engineers
1801 Alexander Bell Drive, Reston, VA 20191-4400
(800) 548-2723
www.asce.org

Associated General Contractors of America
2300 Wilson Boulevard, Suite 400, Arlington, VA 22201-3308
(703) 548-3118
www.agc.org

The copyright for this EJCDC document is owned jointly by the four EJCDC sponsoring organizations and held in trust for their benefit by NSPE.

STANDARD GENERAL CONDITIONS OF THE CONSTRUCTION CONTRACT

TABLE OF CONTENTS

	Page
Article 1 – Definitions and Terminology	1
1.01 Defined Terms.....	1
1.02 Terminology	5
Article 2 – Preliminary Matters.....	6
2.01 Delivery of Bonds and Evidence of Insurance.....	6
2.02 Copies of Documents.....	6
2.03 Commencement of Contract Times; Notice to Proceed	6
2.04 Starting the Work.....	7
2.05 Before Starting Construction	7
2.06 Preconstruction Conference; Designation of Authorized Representatives	7
2.07 Initial Acceptance of Schedules	7
Article 3 – Contract Documents: Intent, Amending, Reuse.....	8
3.01 Intent.....	8
3.02 Reference Standards	8
3.03 Reporting and Resolving Discrepancies	8
3.04 Amending and Supplementing Contract Documents	9
3.05 Reuse of Documents	10
3.06 Electronic Data.....	10
Article 4 – Availability of Lands; Subsurface and Physical Conditions; Hazardous Environmental Conditions; Reference Points	10
4.01 Availability of Lands	10
4.02 Subsurface and Physical Conditions	11
4.03 Differing Subsurface or Physical Conditions.....	11
4.04 Underground Facilities	13
4.05 Reference Points	14
4.06 Hazardous Environmental Condition at Site.....	14
Article 5 – Bonds and Insurance	16
5.01 Performance, Payment, and Other Bonds	16
5.02 Licensed Sureties and Insurers	16
5.03 Certificates of Insurance	16
5.04 Contractor’s Insurance.....	17
5.05 Owner’s Liability Insurance	18
5.06 Property Insurance	18
5.07 Waiver of Rights	20
5.08 Receipt and Application of Insurance Proceeds	21
5.09 Acceptance of Bonds and Insurance; Option to Replace.....	21

5.10	Partial Utilization, Acknowledgment of Property Insurer	21
Article 6 – Contractor’s Responsibilities		
6.01	Supervision and Superintendence	22
6.02	Labor; Working Hours.....	22
6.03	Services, Materials, and Equipment	22
6.04	Progress Schedule	23
6.05	Substitutes and “Or-Equals”	23
6.06	Concerning Subcontractors, Suppliers, and Others	25
6.07	Patent Fees and Royalties	26
6.08	Permits.....	27
6.09	Laws and Regulations	27
6.10	Taxes	28
6.11	Use of Site and Other Areas	28
6.12	Record Documents.....	29
6.13	Safety and Protection	29
6.14	Safety Representative	30
6.15	Hazard Communication Programs	30
6.16	Emergencies	30
6.17	Shop Drawings and Samples	30
6.18	Continuing the Work	32
6.19	Contractor’s General Warranty and Guarantee.....	32
6.20	Indemnification	33
6.21	Delegation of Professional Design Services	34
Article 7 – Other Work at the Site.....		
7.01	Related Work at Site	34
7.02	Coordination.....	35
7.03	Legal Relationships.....	35
Article 8 – Owner’s Responsibilities		
8.01	Communications to Contractor.....	36
8.02	Replacement of Engineer.....	36
8.03	Furnish Data	36
8.04	Pay When Due	36
8.05	Lands and Easements; Reports and Tests	36
8.06	Insurance	36
8.07	Change Orders.....	36
8.08	Inspections, Tests, and Approvals	36
8.09	Limitations on Owner’s Responsibilities	36
8.10	Undisclosed Hazardous Environmental Condition.....	37
8.11	Evidence of Financial Arrangements	37
8.12	Compliance with Safety Program.....	37
Article 9 – Engineer’s Status During Construction		
9.01	Owner’s Representative.....	37
9.02	Visits to Site	37
9.03	Project Representative	38

9.04	Authorized Variations in Work	38
9.05	Rejecting Defective Work	38
9.06	Shop Drawings, Change Orders and Payments	38
9.07	Determinations for Unit Price Work	38
9.08	Decisions on Requirements of Contract Documents and Acceptability of Work	39
9.09	Limitations on Engineer’s Authority and Responsibilities.....	39
9.10	Compliance with Safety Program.....	40
Article 10 – Changes in the Work; Claims		40
10.01	Authorized Changes in the Work	40
10.02	Unauthorized Changes in the Work	40
10.03	Execution of Change Orders.....	40
10.04	Notification to Surety.....	41
10.05	Claims.....	41
Article 11 – Cost of the Work; Allowances; Unit Price Work.....		42
11.01	Cost of the Work.....	42
11.02	Allowances.....	44
11.03	Unit Price Work	45
Article 12 – Change of Contract Price; Change of Contract Times.....		45
12.01	Change of Contract Price.....	45
12.02	Change of Contract Times.....	47
12.03	Delays.....	47
Article 13 – Tests and Inspections; Correction, Removal or Acceptance of Defective Work.....		48
13.01	Notice of Defects	48
13.02	Access to Work	48
13.03	Tests and Inspections	48
13.04	Uncovering Work.....	49
13.05	Owner May Stop the Work.....	49
13.06	Correction or Removal of Defective Work.....	49
13.07	Correction Period.....	50
13.08	Acceptance of Defective Work	51
13.09	Owner May Correct Defective Work.....	51
Article 14 – Payments to Contractor and Completion.....		52
14.01	Schedule of Values	52
14.02	Progress Payments	52
14.03	Contractor’s Warranty of Title	54
14.04	Substantial Completion.....	55
14.05	Partial Utilization	55
14.06	Final Inspection.....	56
14.07	Final Payment	56
14.08	Final Completion Delayed.....	57
14.09	Waiver of Claims	58

Article 15 – Suspension of Work and Termination	58
15.01 Owner May Suspend Work	58
15.02 Owner May Terminate for Cause	58
15.03 Owner May Terminate For Convenience.....	59
15.04 Contractor May Stop Work or Terminate	60
Article 16 – Dispute Resolution	60
16.01 Methods and Procedures.....	60
Article 17 – Miscellaneous.....	61
17.01 Giving Notice.....	61
17.02 Computation of Times	61
17.03 Cumulative Remedies	61
17.04 Survival of Obligations.....	61
17.05 Controlling Law	61
17.06 Headings.....	61

ARTICLE 1 – DEFINITIONS AND TERMINOLOGY

1.01 *Defined Terms*

- A. Wherever used in the Bidding Requirements or Contract Documents and printed with initial capital letters, the terms listed below will have the meanings indicated which are applicable to both the singular and plural thereof. In addition to terms specifically defined, terms with initial capital letters in the Contract Documents include references to identified articles and paragraphs, and the titles of other documents or forms.
1. *Addenda*—Written or graphic instruments issued prior to the opening of Bids which clarify, correct, or change the Bidding Requirements or the proposed Contract Documents.
 2. *Agreement*—The written instrument which is evidence of the agreement between Owner and Contractor covering the Work.
 3. *Application for Payment*—The form acceptable to Engineer which is to be used by Contractor during the course of the Work in requesting progress or final payments and which is to be accompanied by such supporting documentation as is required by the Contract Documents.
 4. *Asbestos*—Any material that contains more than one percent asbestos and is friable or is releasing asbestos fibers into the air above current action levels established by the United States Occupational Safety and Health Administration.
 5. *Bid*—The offer or proposal of a Bidder submitted on the prescribed form setting forth the prices for the Work to be performed.
 6. *Bidder*—The individual or entity who submits a Bid directly to Owner.
 7. *Bidding Documents*—The Bidding Requirements and the proposed Contract Documents (including all Addenda).
 8. *Bidding Requirements*—The advertisement or invitation to bid, Instructions to Bidders, Bid security of acceptable form, if any, and the Bid Form with any supplements.
 9. *Change Order*—A document recommended by Engineer which is signed by Contractor and Owner and authorizes an addition, deletion, or revision in the Work or an adjustment in the Contract Price or the Contract Times, issued on or after the Effective Date of the Agreement.
 10. *Claim*—A demand or assertion by Owner or Contractor seeking an adjustment of Contract Price or Contract Times, or both, or other relief with respect to the terms of the Contract. A demand for money or services by a third party is not a Claim.
 11. *Contract*—The entire and integrated written agreement between the Owner and Contractor concerning the Work. The Contract supersedes prior negotiations, representations, or agreements, whether written or oral.

12. *Contract Documents*—Those items so designated in the Agreement. Only printed or hard copies of the items listed in the Agreement are Contract Documents. Approved Shop Drawings, other Contractor submittals, and the reports and drawings of subsurface and physical conditions are not Contract Documents.
13. *Contract Price*—The moneys payable by Owner to Contractor for completion of the Work in accordance with the Contract Documents as stated in the Agreement (subject to the provisions of Paragraph 11.03 in the case of Unit Price Work).
14. *Contract Times*—The number of days or the dates stated in the Agreement to: (i) achieve Milestones, if any; (ii) achieve Substantial Completion; and (iii) complete the Work so that it is ready for final payment as evidenced by Engineer's written recommendation of final payment.
15. *Contractor*—The individual or entity with whom Owner has entered into the Agreement.
16. *Cost of the Work*—See Paragraph 11.01 for definition.
17. *Drawings*—That part of the Contract Documents prepared or approved by Engineer which graphically shows the scope, extent, and character of the Work to be performed by Contractor. Shop Drawings and other Contractor submittals are not Drawings as so defined.
18. *Effective Date of the Agreement*—The date indicated in the Agreement on which it becomes effective, but if no such date is indicated, it means the date on which the Agreement is signed and delivered by the last of the two parties to sign and deliver.
19. *Engineer*—The individual or entity named as such in the Agreement.
20. *Field Order*—A written order issued by Engineer which requires minor changes in the Work but which does not involve a change in the Contract Price or the Contract Times.
21. *General Requirements*—Sections of Division 1 of the Specifications.
22. *Hazardous Environmental Condition*—The presence at the Site of Asbestos, PCBs, Petroleum, Hazardous Waste, or Radioactive Material in such quantities or circumstances that may present a substantial danger to persons or property exposed thereto.
23. *Hazardous Waste*—The term Hazardous Waste shall have the meaning provided in Section 1004 of the Solid Waste Disposal Act (42 USC Section 6903) as amended from time to time.
24. *Laws and Regulations; Laws or Regulations*—Any and all applicable laws, rules, regulations, ordinances, codes, and orders of any and all governmental bodies, agencies, authorities, and courts having jurisdiction.
25. *Liens*—Charges, security interests, or encumbrances upon Project funds, real property, or personal property.
26. *Milestone*—A principal event specified in the Contract Documents relating to an intermediate completion date or time prior to Substantial Completion of all the Work.

27. *Notice of Award*—The written notice by Owner to the Successful Bidder stating that upon timely compliance by the Successful Bidder with the conditions precedent listed therein, Owner will sign and deliver the Agreement.
28. *Notice to Proceed*—A written notice given by Owner to Contractor fixing the date on which the Contract Times will commence to run and on which Contractor shall start to perform the Work under the Contract Documents.
29. *Owner*—The individual or entity with whom Contractor has entered into the Agreement and for whom the Work is to be performed.
30. *PCBs*—Polychlorinated biphenyls.
31. *Petroleum*—Petroleum, including crude oil or any fraction thereof which is liquid at standard conditions of temperature and pressure (60 degrees Fahrenheit and 14.7 pounds per square inch absolute), such as oil, petroleum, fuel oil, oil sludge, oil refuse, gasoline, kerosene, and oil mixed with other non-Hazardous Waste and crude oils.
32. *Progress Schedule*—A schedule, prepared and maintained by Contractor, describing the sequence and duration of the activities comprising the Contractor's plan to accomplish the Work within the Contract Times.
33. *Project*—The total construction of which the Work to be performed under the Contract Documents may be the whole, or a part.
34. *Project Manual*—The bound documentary information prepared for bidding and constructing the Work. A listing of the contents of the Project Manual, which may be bound in one or more volumes, is contained in the table(s) of contents.
35. *Radioactive Material*—Source, special nuclear, or byproduct material as defined by the Atomic Energy Act of 1954 (42 USC Section 2011 et seq.) as amended from time to time.
36. *Resident Project Representative*—The authorized representative of Engineer who may be assigned to the Site or any part thereof.
37. *Samples*—Physical examples of materials, equipment, or workmanship that are representative of some portion of the Work and which establish the standards by which such portion of the Work will be judged.
38. *Schedule of Submittals*—A schedule, prepared and maintained by Contractor, of required submittals and the time requirements to support scheduled performance of related construction activities.
39. *Schedule of Values*—A schedule, prepared and maintained by Contractor, allocating portions of the Contract Price to various portions of the Work and used as the basis for reviewing Contractor's Applications for Payment.

40. *Shop Drawings*—All drawings, diagrams, illustrations, schedules, and other data or information which are specifically prepared or assembled by or for Contractor and submitted by Contractor to illustrate some portion of the Work.
41. *Site*—Lands or areas indicated in the Contract Documents as being furnished by Owner upon which the Work is to be performed, including rights-of-way and easements for access thereto, and such other lands furnished by Owner which are designated for the use of Contractor.
42. *Specifications*—That part of the Contract Documents consisting of written requirements for materials, equipment, systems, standards and workmanship as applied to the Work, and certain administrative requirements and procedural matters applicable thereto.
43. *Subcontractor*—An individual or entity having a direct contract with Contractor or with any other Subcontractor for the performance of a part of the Work at the Site.
44. *Substantial Completion*—The time at which the Work (or a specified part thereof) has progressed to the point where, in the opinion of Engineer, the Work (or a specified part thereof) is sufficiently complete, in accordance with the Contract Documents, so that the Work (or a specified part thereof) can be utilized for the purposes for which it is intended. The terms “substantially complete” and “substantially completed” as applied to all or part of the Work refer to Substantial Completion thereof.
45. *Successful Bidder*—The Bidder submitting a responsive Bid to whom Owner makes an award.
46. *Supplementary Conditions*—That part of the Contract Documents which amends or supplements these General Conditions.
47. *Supplier*—A manufacturer, fabricator, supplier, distributor, materialman, or vendor having a direct contract with Contractor or with any Subcontractor to furnish materials or equipment to be incorporated in the Work by Contractor or Subcontractor.
48. *Underground Facilities*—All underground pipelines, conduits, ducts, cables, wires, manholes, vaults, tanks, tunnels, or other such facilities or attachments, and any encasements containing such facilities, including those that convey electricity, gases, steam, liquid petroleum products, telephone or other communications, cable television, water, wastewater, storm water, other liquids or chemicals, or traffic or other control systems.
49. *Unit Price Work*—Work to be paid for on the basis of unit prices.
50. *Work*—The entire construction or the various separately identifiable parts thereof required to be provided under the Contract Documents. Work includes and is the result of performing or providing all labor, services, and documentation necessary to produce such construction, and furnishing, installing, and incorporating all materials and equipment into such construction, all as required by the Contract Documents.
51. *Work Change Directive*—A written statement to Contractor issued on or after the Effective Date of the Agreement and signed by Owner and recommended by Engineer ordering an

addition, deletion, or revision in the Work, or responding to differing or unforeseen subsurface or physical conditions under which the Work is to be performed or to emergencies. A Work Change Directive will not change the Contract Price or the Contract Times but is evidence that the parties expect that the change ordered or documented by a Work Change Directive will be incorporated in a subsequently issued Change Order following negotiations by the parties as to its effect, if any, on the Contract Price or Contract Times.

1.02 *Terminology*

A. The words and terms discussed in Paragraph 1.02.B through F are not defined but, when used in the Bidding Requirements or Contract Documents, have the indicated meaning.

B. *Intent of Certain Terms or Adjectives:*

1. The Contract Documents include the terms “as allowed,” “as approved,” “as ordered,” “as directed” or terms of like effect or import to authorize an exercise of professional judgment by Engineer. In addition, the adjectives “reasonable,” “suitable,” “acceptable,” “proper,” “satisfactory,” or adjectives of like effect or import are used to describe an action or determination of Engineer as to the Work. It is intended that such exercise of professional judgment, action, or determination will be solely to evaluate, in general, the Work for compliance with the information in the Contract Documents and with the design concept of the Project as a functioning whole as shown or indicated in the Contract Documents (unless there is a specific statement indicating otherwise). The use of any such term or adjective is not intended to and shall not be effective to assign to Engineer any duty or authority to supervise or direct the performance of the Work, or any duty or authority to undertake responsibility contrary to the provisions of Paragraph 9.09 or any other provision of the Contract Documents.

C. *Day:*

1. The word “day” means a calendar day of 24 hours measured from midnight to the next midnight.

D. *Defective:*

1. The word “defective,” when modifying the word “Work,” refers to Work that is unsatisfactory, faulty, or deficient in that it:
 - a. does not conform to the Contract Documents; or
 - b. does not meet the requirements of any applicable inspection, reference standard, test, or approval referred to in the Contract Documents; or
 - c. has been damaged prior to Engineer’s recommendation of final payment (unless responsibility for the protection thereof has been assumed by Owner at Substantial Completion in accordance with Paragraph 14.04 or 14.05).

E. *Furnish, Install, Perform, Provide:*

1. The word “furnish,” when used in connection with services, materials, or equipment, shall mean to supply and deliver said services, materials, or equipment to the Site (or some other specified location) ready for use or installation and in usable or operable condition.
 2. The word “install,” when used in connection with services, materials, or equipment, shall mean to put into use or place in final position said services, materials, or equipment complete and ready for intended use.
 3. The words “perform” or “provide,” when used in connection with services, materials, or equipment, shall mean to furnish and install said services, materials, or equipment complete and ready for intended use.
 4. When “furnish,” “install,” “perform,” or “provide” is not used in connection with services, materials, or equipment in a context clearly requiring an obligation of Contractor, “provide” is implied.
- F. Unless stated otherwise in the Contract Documents, words or phrases that have a well-known technical or construction industry or trade meaning are used in the Contract Documents in accordance with such recognized meaning.

ARTICLE 2 – PRELIMINARY MATTERS

2.01 Delivery of Bonds and Evidence of Insurance

- A. When Contractor delivers the executed counterparts of the Agreement to Owner, Contractor shall also deliver to Owner such bonds as Contractor may be required to furnish.
- B. *Evidence of Insurance:* Before any Work at the Site is started, Contractor and Owner shall each deliver to the other, with copies to each additional insured identified in the Supplementary Conditions, certificates of insurance (and other evidence of insurance which either of them or any additional insured may reasonably request) which Contractor and Owner respectively are required to purchase and maintain in accordance with Article 5.

2.02 Copies of Documents

- A. Owner shall furnish to Contractor up to ten printed or hard copies of the Drawings and Project Manual. Additional copies will be furnished upon request at the cost of reproduction.

2.03 Commencement of Contract Times; Notice to Proceed

- A. The Contract Times will commence to run on the thirtieth day after the Effective Date of the Agreement or, if a Notice to Proceed is given, on the day indicated in the Notice to Proceed. A Notice to Proceed may be given at any time within 30 days after the Effective Date of the Agreement. In no event will the Contract Times commence to run later than the sixtieth day after the day of Bid opening or the thirtieth day after the Effective Date of the Agreement, whichever date is earlier.

2.04 *Starting the Work*

- A. Contractor shall start to perform the Work on the date when the Contract Times commence to run. No Work shall be done at the Site prior to the date on which the Contract Times commence to run.

2.05 *Before Starting Construction*

- A. *Preliminary Schedules:* Within 10 days after the Effective Date of the Agreement (unless otherwise specified in the General Requirements), Contractor shall submit to Engineer for timely review:
 - 1. a preliminary Progress Schedule indicating the times (numbers of days or dates) for starting and completing the various stages of the Work, including any Milestones specified in the Contract Documents;
 - 2. a preliminary Schedule of Submittals; and
 - 3. a preliminary Schedule of Values for all of the Work which includes quantities and prices of items which when added together equal the Contract Price and subdivides the Work into component parts in sufficient detail to serve as the basis for progress payments during performance of the Work. Such prices will include an appropriate amount of overhead and profit applicable to each item of Work.

2.06 *Preconstruction Conference; Designation of Authorized Representatives*

- A. Before any Work at the Site is started, a conference attended by Owner, Contractor, Engineer, and others as appropriate will be held to establish a working understanding among the parties as to the Work and to discuss the schedules referred to in Paragraph 2.05.A, procedures for handling Shop Drawings and other submittals, processing Applications for Payment, and maintaining required records.
- B. At this conference Owner and Contractor each shall designate, in writing, a specific individual to act as its authorized representative with respect to the services and responsibilities under the Contract. Such individuals shall have the authority to transmit instructions, receive information, render decisions relative to the Contract, and otherwise act on behalf of each respective party.

2.07 *Initial Acceptance of Schedules*

- A. At least 10 days before submission of the first Application for Payment a conference attended by Contractor, Engineer, and others as appropriate will be held to review for acceptability to Engineer as provided below the schedules submitted in accordance with Paragraph 2.05.A. Contractor shall have an additional 10 days to make corrections and adjustments and to complete and resubmit the schedules. No progress payment shall be made to Contractor until acceptable schedules are submitted to Engineer.
 - 1. The Progress Schedule will be acceptable to Engineer if it provides an orderly progression of the Work to completion within the Contract Times. Such acceptance will not impose on Engineer responsibility for the Progress Schedule, for sequencing, scheduling, or progress of

the Work, nor interfere with or relieve Contractor from Contractor's full responsibility therefor.

2. Contractor's Schedule of Submittals will be acceptable to Engineer if it provides a workable arrangement for reviewing and processing the required submittals.
3. Contractor's Schedule of Values will be acceptable to Engineer as to form and substance if it provides a reasonable allocation of the Contract Price to component parts of the Work.

ARTICLE 3 – CONTRACT DOCUMENTS: INTENT, AMENDING, REUSE

3.01 *Intent*

- A. The Contract Documents are complementary; what is required by one is as binding as if required by all.
- B. It is the intent of the Contract Documents to describe a functionally complete project (or part thereof) to be constructed in accordance with the Contract Documents. Any labor, documentation, services, materials, or equipment that reasonably may be inferred from the Contract Documents or from prevailing custom or trade usage as being required to produce the indicated result will be provided whether or not specifically called for, at no additional cost to Owner.
- C. Clarifications and interpretations of the Contract Documents shall be issued by Engineer as provided in Article 9.

3.02 *Reference Standards*

- A. Standards, Specifications, Codes, Laws, and Regulations
 1. Reference to standards, specifications, manuals, or codes of any technical society, organization, or association, or to Laws or Regulations, whether such reference be specific or by implication, shall mean the standard, specification, manual, code, or Laws or Regulations in effect at the time of opening of Bids (or on the Effective Date of the Agreement if there were no Bids), except as may be otherwise specifically stated in the Contract Documents.
 2. No provision of any such standard, specification, manual, or code, or any instruction of a Supplier, shall be effective to change the duties or responsibilities of Owner, Contractor, or Engineer, or any of their subcontractors, consultants, agents, or employees, from those set forth in the Contract Documents. No such provision or instruction shall be effective to assign to Owner, Engineer, or any of their officers, directors, members, partners, employees, agents, consultants, or subcontractors, any duty or authority to supervise or direct the performance of the Work or any duty or authority to undertake responsibility inconsistent with the provisions of the Contract Documents.

3.03 *Reporting and Resolving Discrepancies*

- A. *Reporting Discrepancies:*

1. *Contractor's Review of Contract Documents Before Starting Work:* Before undertaking each part of the Work, Contractor shall carefully study and compare the Contract Documents and check and verify pertinent figures therein and all applicable field measurements. Contractor shall promptly report in writing to Engineer any conflict, error, ambiguity, or discrepancy which Contractor discovers, or has actual knowledge of, and shall obtain a written interpretation or clarification from Engineer before proceeding with any Work affected thereby.
2. *Contractor's Review of Contract Documents During Performance of Work:* If, during the performance of the Work, Contractor discovers any conflict, error, ambiguity, or discrepancy within the Contract Documents, or between the Contract Documents and (a) any applicable Law or Regulation, (b) any standard, specification, manual, or code, or (c) any instruction of any Supplier, then Contractor shall promptly report it to Engineer in writing. Contractor shall not proceed with the Work affected thereby (except in an emergency as required by Paragraph 6.16.A) until an amendment or supplement to the Contract Documents has been issued by one of the methods indicated in Paragraph 3.04.
3. Contractor shall not be liable to Owner or Engineer for failure to report any conflict, error, ambiguity, or discrepancy in the Contract Documents unless Contractor had actual knowledge thereof.

B. *Resolving Discrepancies:*

1. Except as may be otherwise specifically stated in the Contract Documents, the provisions of the Contract Documents shall take precedence in resolving any conflict, error, ambiguity, or discrepancy between the provisions of the Contract Documents and:
 - a. the provisions of any standard, specification, manual, or code, or the instruction of any Supplier (whether or not specifically incorporated by reference in the Contract Documents); or
 - b. the provisions of any Laws or Regulations applicable to the performance of the Work (unless such an interpretation of the provisions of the Contract Documents would result in violation of such Law or Regulation).

3.04 *Amending and Supplementing Contract Documents*

- A. The Contract Documents may be amended to provide for additions, deletions, and revisions in the Work or to modify the terms and conditions thereof by either a Change Order or a Work Change Directive.
- B. The requirements of the Contract Documents may be supplemented, and minor variations and deviations in the Work may be authorized, by one or more of the following ways:
 1. A Field Order;
 2. Engineer's approval of a Shop Drawing or Sample (subject to the provisions of Paragraph 6.17.D.3); or

3. Engineer's written interpretation or clarification.

3.05 *Reuse of Documents*

- A. Contractor and any Subcontractor or Supplier shall not:
 1. have or acquire any title to or ownership rights in any of the Drawings, Specifications, or other documents (or copies of any thereof) prepared by or bearing the seal of Engineer or its consultants, including electronic media editions; or
 2. reuse any such Drawings, Specifications, other documents, or copies thereof on extensions of the Project or any other project without written consent of Owner and Engineer and specific written verification or adaptation by Engineer.
- B. The prohibitions of this Paragraph 3.05 will survive final payment, or termination of the Contract. Nothing herein shall preclude Contractor from retaining copies of the Contract Documents for record purposes.

3.06 *Electronic Data*

- A. Unless otherwise stated in the Supplementary Conditions, the data furnished by Owner or Engineer to Contractor, or by Contractor to Owner or Engineer, that may be relied upon are limited to the printed copies (also known as hard copies). Files in electronic media format of text, data, graphics, or other types are furnished only for the convenience of the receiving party. Any conclusion or information obtained or derived from such electronic files will be at the user's sole risk. If there is a discrepancy between the electronic files and the hard copies, the hard copies govern.
- B. Because data stored in electronic media format can deteriorate or be modified inadvertently or otherwise without authorization of the data's creator, the party receiving electronic files agrees that it will perform acceptance tests or procedures within 60 days, after which the receiving party shall be deemed to have accepted the data thus transferred. Any errors detected within the 60-day acceptance period will be corrected by the transferring party.
- C. When transferring documents in electronic media format, the transferring party makes no representations as to long term compatibility, usability, or readability of documents resulting from the use of software application packages, operating systems, or computer hardware differing from those used by the data's creator.

ARTICLE 4 – AVAILABILITY OF LANDS; SUBSURFACE AND PHYSICAL CONDITIONS; HAZARDOUS ENVIRONMENTAL CONDITIONS; REFERENCE POINTS

4.01 *Availability of Lands*

- A. Owner shall furnish the Site. Owner shall notify Contractor of any encumbrances or restrictions not of general application but specifically related to use of the Site with which Contractor must comply in performing the Work. Owner will obtain in a timely manner and pay for easements for permanent structures or permanent changes in existing facilities. If Contractor and Owner are unable to agree on entitlement to or on the amount or extent, if any, of any adjustment in the

Contract Price or Contract Times, or both, as a result of any delay in Owner's furnishing the Site or a part thereof, Contractor may make a Claim therefor as provided in Paragraph 10.05.

- B. Upon reasonable written request, Owner shall furnish Contractor with a current statement of record legal title and legal description of the lands upon which the Work is to be performed and Owner's interest therein as necessary for giving notice of or filing a mechanic's or construction lien against such lands in accordance with applicable Laws and Regulations.
- C. Contractor shall provide for all additional lands and access thereto that may be required for temporary construction facilities or storage of materials and equipment.

4.02 *Subsurface and Physical Conditions*

A. *Reports and Drawings:* The Supplementary Conditions identify:

- 1. those reports known to Owner of explorations and tests of subsurface conditions at or contiguous to the Site; and
- 2. those drawings known to Owner of physical conditions relating to existing surface or subsurface structures at the Site (except Underground Facilities).

B. *Limited Reliance by Contractor on Technical Data Authorized:* Contractor may rely upon the accuracy of the "technical data" contained in such reports and drawings, but such reports and drawings are not Contract Documents. Such "technical data" is identified in the Supplementary Conditions. Except for such reliance on such "technical data," Contractor may not rely upon or make any claim against Owner or Engineer, or any of their officers, directors, members, partners, employees, agents, consultants, or subcontractors with respect to:

- 1. the completeness of such reports and drawings for Contractor's purposes, including, but not limited to, any aspects of the means, methods, techniques, sequences, and procedures of construction to be employed by Contractor, and safety precautions and programs incident thereto; or
- 2. other data, interpretations, opinions, and information contained in such reports or shown or indicated in such drawings; or
- 3. any Contractor interpretation of or conclusion drawn from any "technical data" or any such other data, interpretations, opinions, or information.

4.03 *Differing Subsurface or Physical Conditions*

A. *Notice:* If Contractor believes that any subsurface or physical condition that is uncovered or revealed either:

- 1. is of such a nature as to establish that any "technical data" on which Contractor is entitled to rely as provided in Paragraph 4.02 is materially inaccurate; or
- 2. is of such a nature as to require a change in the Contract Documents; or
- 3. differs materially from that shown or indicated in the Contract Documents; or

4. is of an unusual nature, and differs materially from conditions ordinarily encountered and generally recognized as inherent in work of the character provided for in the Contract Documents;

then Contractor shall, promptly after becoming aware thereof and before further disturbing the subsurface or physical conditions or performing any Work in connection therewith (except in an emergency as required by Paragraph 6.16.A), notify Owner and Engineer in writing about such condition. Contractor shall not further disturb such condition or perform any Work in connection therewith (except as aforesaid) until receipt of written order to do so.

- B. *Engineer's Review:* After receipt of written notice as required by Paragraph 4.03.A, Engineer will promptly review the pertinent condition, determine the necessity of Owner's obtaining additional exploration or tests with respect thereto, and advise Owner in writing (with a copy to Contractor) of Engineer's findings and conclusions.

C. *Possible Price and Times Adjustments:*

1. The Contract Price or the Contract Times, or both, will be equitably adjusted to the extent that the existence of such differing subsurface or physical condition causes an increase or decrease in Contractor's cost of, or time required for, performance of the Work; subject, however, to the following:
 - a. such condition must meet any one or more of the categories described in Paragraph 4.03.A; and
 - b. with respect to Work that is paid for on a unit price basis, any adjustment in Contract Price will be subject to the provisions of Paragraphs 9.07 and 11.03.
2. Contractor shall not be entitled to any adjustment in the Contract Price or Contract Times if:
 - a. Contractor knew of the existence of such conditions at the time Contractor made a final commitment to Owner with respect to Contract Price and Contract Times by the submission of a Bid or becoming bound under a negotiated contract; or
 - b. the existence of such condition could reasonably have been discovered or revealed as a result of any examination, investigation, exploration, test, or study of the Site and contiguous areas required by the Bidding Requirements or Contract Documents to be conducted by or for Contractor prior to Contractor's making such final commitment; or
 - c. Contractor failed to give the written notice as required by Paragraph 4.03.A.
3. If Owner and Contractor are unable to agree on entitlement to or on the amount or extent, if any, of any adjustment in the Contract Price or Contract Times, or both, a Claim may be made therefor as provided in Paragraph 10.05. However, neither Owner or Engineer, or any of their officers, directors, members, partners, employees, agents, consultants, or subcontractors shall be liable to Contractor for any claims, costs, losses, or damages (including but not limited to all fees and charges of engineers, architects, attorneys, and other professionals and all court or arbitration or other dispute resolution costs) sustained by Contractor on or in connection with any other project or anticipated project.

4.04 *Underground Facilities*

A. *Shown or Indicated:* The information and data shown or indicated in the Contract Documents with respect to existing Underground Facilities at or contiguous to the Site is based on information and data furnished to Owner or Engineer by the owners of such Underground Facilities, including Owner, or by others. Unless it is otherwise expressly provided in the Supplementary Conditions:

1. Owner and Engineer shall not be responsible for the accuracy or completeness of any such information or data provided by others; and
2. the cost of all of the following will be included in the Contract Price, and Contractor shall have full responsibility for:
 - a. reviewing and checking all such information and data;
 - b. locating all Underground Facilities shown or indicated in the Contract Documents;
 - c. coordination of the Work with the owners of such Underground Facilities, including Owner, during construction; and
 - d. the safety and protection of all such Underground Facilities and repairing any damage thereto resulting from the Work.

B. *Not Shown or Indicated:*

1. If an Underground Facility is uncovered or revealed at or contiguous to the Site which was not shown or indicated, or not shown or indicated with reasonable accuracy in the Contract Documents, Contractor shall, promptly after becoming aware thereof and before further disturbing conditions affected thereby or performing any Work in connection therewith (except in an emergency as required by Paragraph 6.16.A), identify the owner of such Underground Facility and give written notice to that owner and to Owner and Engineer. Engineer will promptly review the Underground Facility and determine the extent, if any, to which a change is required in the Contract Documents to reflect and document the consequences of the existence or location of the Underground Facility. During such time, Contractor shall be responsible for the safety and protection of such Underground Facility.
2. If Engineer concludes that a change in the Contract Documents is required, a Work Change Directive or a Change Order will be issued to reflect and document such consequences. An equitable adjustment shall be made in the Contract Price or Contract Times, or both, to the extent that they are attributable to the existence or location of any Underground Facility that was not shown or indicated or not shown or indicated with reasonable accuracy in the Contract Documents and that Contractor did not know of and could not reasonably have been expected to be aware of or to have anticipated. If Owner and Contractor are unable to agree on entitlement to or on the amount or extent, if any, of any such adjustment in Contract Price or Contract Times, Owner or Contractor may make a Claim therefor as provided in Paragraph 10.05.

4.05 *Reference Points*

- A. Owner shall provide engineering surveys to establish reference points for construction which in Engineer's judgment are necessary to enable Contractor to proceed with the Work. Contractor shall be responsible for laying out the Work, shall protect and preserve the established reference points and property monuments, and shall make no changes or relocations without the prior written approval of Owner. Contractor shall report to Engineer whenever any reference point or property monument is lost or destroyed or requires relocation because of necessary changes in grades or locations, and shall be responsible for the accurate replacement or relocation of such reference points or property monuments by professionally qualified personnel.

4.06 *Hazardous Environmental Condition at Site*

- A. *Reports and Drawings:* The Supplementary Conditions identify those reports and drawings known to Owner relating to Hazardous Environmental Conditions that have been identified at the Site.
- B. *Limited Reliance by Contractor on Technical Data Authorized:* Contractor may rely upon the accuracy of the "technical data" contained in such reports and drawings, but such reports and drawings are not Contract Documents. Such "technical data" is identified in the Supplementary Conditions. Except for such reliance on such "technical data," Contractor may not rely upon or make any claim against Owner or Engineer, or any of their officers, directors, members, partners, employees, agents, consultants, or subcontractors with respect to:
 - 1. the completeness of such reports and drawings for Contractor's purposes, including, but not limited to, any aspects of the means, methods, techniques, sequences and procedures of construction to be employed by Contractor and safety precautions and programs incident thereto; or
 - 2. other data, interpretations, opinions and information contained in such reports or shown or indicated in such drawings; or
 - 3. any Contractor interpretation of or conclusion drawn from any "technical data" or any such other data, interpretations, opinions or information.
- C. Contractor shall not be responsible for any Hazardous Environmental Condition uncovered or revealed at the Site which was not shown or indicated in Drawings or Specifications or identified in the Contract Documents to be within the scope of the Work. Contractor shall be responsible for a Hazardous Environmental Condition created with any materials brought to the Site by Contractor, Subcontractors, Suppliers, or anyone else for whom Contractor is responsible.
- D. If Contractor encounters a Hazardous Environmental Condition or if Contractor or anyone for whom Contractor is responsible creates a Hazardous Environmental Condition, Contractor shall immediately: (i) secure or otherwise isolate such condition; (ii) stop all Work in connection with such condition and in any area affected thereby (except in an emergency as required by Paragraph 6.16.A); and (iii) notify Owner and Engineer (and promptly thereafter confirm such notice in writing). Owner shall promptly consult with Engineer concerning the necessity for Owner to retain a qualified expert to evaluate such condition or take corrective action, if any. Promptly after consulting with Engineer, Owner shall take such actions as are necessary to

permit Owner to timely obtain required permits and provide Contractor the written notice required by Paragraph 4.06.E.

- E. Contractor shall not be required to resume Work in connection with such condition or in any affected area until after Owner has obtained any required permits related thereto and delivered written notice to Contractor: (i) specifying that such condition and any affected area is or has been rendered safe for the resumption of Work; or (ii) specifying any special conditions under which such Work may be resumed safely. If Owner and Contractor cannot agree as to entitlement to or on the amount or extent, if any, of any adjustment in Contract Price or Contract Times, or both, as a result of such Work stoppage or such special conditions under which Work is agreed to be resumed by Contractor, either party may make a Claim therefor as provided in Paragraph 10.05.
- F. If after receipt of such written notice Contractor does not agree to resume such Work based on a reasonable belief it is unsafe, or does not agree to resume such Work under such special conditions, then Owner may order the portion of the Work that is in the area affected by such condition to be deleted from the Work. If Owner and Contractor cannot agree as to entitlement to or on the amount or extent, if any, of an adjustment in Contract Price or Contract Times as a result of deleting such portion of the Work, then either party may make a Claim therefor as provided in Paragraph 10.05. Owner may have such deleted portion of the Work performed by Owner's own forces or others in accordance with Article 7.
- G. To the fullest extent permitted by Laws and Regulations, Owner shall indemnify and hold harmless Contractor, Subcontractors, and Engineer, and the officers, directors, members, partners, employees, agents, consultants, and subcontractors of each and any of them from and against all claims, costs, losses, and damages (including but not limited to all fees and charges of engineers, architects, attorneys, and other professionals and all court or arbitration or other dispute resolution costs) arising out of or relating to a Hazardous Environmental Condition, provided that such Hazardous Environmental Condition: (i) was not shown or indicated in the Drawings or Specifications or identified in the Contract Documents to be included within the scope of the Work, and (ii) was not created by Contractor or by anyone for whom Contractor is responsible. Nothing in this Paragraph 4.06.G shall obligate Owner to indemnify any individual or entity from and against the consequences of that individual's or entity's own negligence.
- H. To the fullest extent permitted by Laws and Regulations, Contractor shall indemnify and hold harmless Owner and Engineer, and the officers, directors, members, partners, employees, agents, consultants, and subcontractors of each and any of them from and against all claims, costs, losses, and damages (including but not limited to all fees and charges of engineers, architects, attorneys, and other professionals and all court or arbitration or other dispute resolution costs) arising out of or relating to a Hazardous Environmental Condition created by Contractor or by anyone for whom Contractor is responsible. Nothing in this Paragraph 4.06.H shall obligate Contractor to indemnify any individual or entity from and against the consequences of that individual's or entity's own negligence.
- I. The provisions of Paragraphs 4.02, 4.03, and 4.04 do not apply to a Hazardous Environmental Condition uncovered or revealed at the Site.

ARTICLE 5 – BONDS AND INSURANCE

5.01 *Performance, Payment, and Other Bonds*

- A. Contractor shall furnish performance and payment bonds, each in an amount at least equal to the Contract Price as security for the faithful performance and payment of all of Contractor's obligations under the Contract Documents. These bonds shall remain in effect until one year after the date when final payment becomes due or until completion of the correction period specified in Paragraph 13.07, whichever is later, except as provided otherwise by Laws or Regulations or by the Contract Documents. Contractor shall also furnish such other bonds as are required by the Contract Documents.
- B. All bonds shall be in the form prescribed by the Contract Documents except as provided otherwise by Laws or Regulations, and shall be executed by such sureties as are named in the list of "Companies Holding Certificates of Authority as Acceptable Sureties on Federal Bonds and as Acceptable Reinsuring Companies" as published in Circular 570 (amended) by the Financial Management Service, Surety Bond Branch, U.S. Department of the Treasury. All bonds signed by an agent or attorney-in-fact must be accompanied by a certified copy of that individual's authority to bind the surety. The evidence of authority shall show that it is effective on the date the agent or attorney-in-fact signed each bond.
- C. If the surety on any bond furnished by Contractor is declared bankrupt or becomes insolvent or its right to do business is terminated in any state where any part of the Project is located or it ceases to meet the requirements of Paragraph 5.01.B, Contractor shall promptly notify Owner and Engineer and shall, within 20 days after the event giving rise to such notification, provide another bond and surety, both of which shall comply with the requirements of Paragraphs 5.01.B and 5.02.

5.02 *Licensed Sureties and Insurers*

- A. All bonds and insurance required by the Contract Documents to be purchased and maintained by Owner or Contractor shall be obtained from surety or insurance companies that are duly licensed or authorized in the jurisdiction in which the Project is located to issue bonds or insurance policies for the limits and coverages so required. Such surety and insurance companies shall also meet such additional requirements and qualifications as may be provided in the Supplementary Conditions.

5.03 *Certificates of Insurance*

- A. Contractor shall deliver to Owner, with copies to each additional insured and loss payee identified in the Supplementary Conditions, certificates of insurance (and other evidence of insurance requested by Owner or any other additional insured) which Contractor is required to purchase and maintain.
- B. Owner shall deliver to Contractor, with copies to each additional insured and loss payee identified in the Supplementary Conditions, certificates of insurance (and other evidence of insurance requested by Contractor or any other additional insured) which Owner is required to purchase and maintain.

- C. Failure of Owner to demand such certificates or other evidence of Contractor's full compliance with these insurance requirements or failure of Owner to identify a deficiency in compliance from the evidence provided shall not be construed as a waiver of Contractor's obligation to maintain such insurance.
- D. Owner does not represent that insurance coverage and limits established in this Contract necessarily will be adequate to protect Contractor.
- E. The insurance and insurance limits required herein shall not be deemed as a limitation on Contractor's liability under the indemnities granted to Owner in the Contract Documents.

5.04 *Contractor's Insurance*

- A. Contractor shall purchase and maintain such insurance as is appropriate for the Work being performed and as will provide protection from claims set forth below which may arise out of or result from Contractor's performance of the Work and Contractor's other obligations under the Contract Documents, whether it is to be performed by Contractor, any Subcontractor or Supplier, or by anyone directly or indirectly employed by any of them to perform any of the Work, or by anyone for whose acts any of them may be liable:
 - 1. claims under workers' compensation, disability benefits, and other similar employee benefit acts;
 - 2. claims for damages because of bodily injury, occupational sickness or disease, or death of Contractor's employees;
 - 3. claims for damages because of bodily injury, sickness or disease, or death of any person other than Contractor's employees;
 - 4. claims for damages insured by reasonably available personal injury liability coverage which are sustained:
 - a. by any person as a result of an offense directly or indirectly related to the employment of such person by Contractor, or
 - b. by any other person for any other reason;
 - 5. claims for damages, other than to the Work itself, because of injury to or destruction of tangible property wherever located, including loss of use resulting therefrom; and
 - 6. claims for damages because of bodily injury or death of any person or property damage arising out of the ownership, maintenance or use of any motor vehicle.
- B. The policies of insurance required by this Paragraph 5.04 shall:
 - 1. with respect to insurance required by Paragraphs 5.04.A.3 through 5.04.A.6 inclusive, be written on an occurrence basis, include as additional insureds (subject to any customary exclusion regarding professional liability) Owner and Engineer, and any other individuals or entities identified in the Supplementary Conditions, all of whom shall be listed as additional insureds, and include coverage for the respective officers, directors, members, partners,

employees, agents, consultants, and subcontractors of each and any of all such additional insureds, and the insurance afforded to these additional insureds shall provide primary coverage for all claims covered thereby;

2. include at least the specific coverages and be written for not less than the limits of liability provided in the Supplementary Conditions or required by Laws or Regulations, whichever is greater;
3. include contractual liability insurance covering Contractor's indemnity obligations under Paragraphs 6.11 and 6.20;
4. contain a provision or endorsement that the coverage afforded will not be canceled, materially changed or renewal refused until at least 30 days prior written notice has been given to Owner and Contractor and to each other additional insured identified in the Supplementary Conditions to whom a certificate of insurance has been issued (and the certificates of insurance furnished by the Contractor pursuant to Paragraph 5.03 will so provide);
5. remain in effect at least until final payment and at all times thereafter when Contractor may be correcting, removing, or replacing defective Work in accordance with Paragraph 13.07; and
6. include completed operations coverage:
 - a. Such insurance shall remain in effect for two years after final payment.
 - b. Contractor shall furnish Owner and each other additional insured identified in the Supplementary Conditions, to whom a certificate of insurance has been issued, evidence satisfactory to Owner and any such additional insured of continuation of such insurance at final payment and one year thereafter.

5.05 *Owner's Liability Insurance*

- A. In addition to the insurance required to be provided by Contractor under Paragraph 5.04, Owner, at Owner's option, may purchase and maintain at Owner's expense Owner's own liability insurance as will protect Owner against claims which may arise from operations under the Contract Documents.

5.06 *Property Insurance*

- A. Unless otherwise provided in the Supplementary Conditions, Owner shall purchase and maintain property insurance upon the Work at the Site in the amount of the full replacement cost thereof (subject to such deductible amounts as may be provided in the Supplementary Conditions or required by Laws and Regulations). This insurance shall:
 1. include the interests of Owner, Contractor, Subcontractors, and Engineer, and any other individuals or entities identified in the Supplementary Conditions, and the officers, directors, members, partners, employees, agents, consultants, and subcontractors of each and any of

them, each of whom is deemed to have an insurable interest and shall be listed as a loss payee;

2. be written on a Builder's Risk "all-risk" policy form that shall at least include insurance for physical loss or damage to the Work, temporary buildings, falsework, and materials and equipment in transit, and shall insure against at least the following perils or causes of loss: fire, lightning, extended coverage, theft, vandalism and malicious mischief, earthquake, collapse, debris removal, demolition occasioned by enforcement of Laws and Regulations, water damage (other than that caused by flood), and such other perils or causes of loss as may be specifically required by the Supplementary Conditions.
 3. include expenses incurred in the repair or replacement of any insured property (including but not limited to fees and charges of engineers and architects);
 4. cover materials and equipment stored at the Site or at another location that was agreed to in writing by Owner prior to being incorporated in the Work, provided that such materials and equipment have been included in an Application for Payment recommended by Engineer;
 5. allow for partial utilization of the Work by Owner;
 6. include testing and startup; and
 7. be maintained in effect until final payment is made unless otherwise agreed to in writing by Owner, Contractor, and Engineer with 30 days written notice to each other loss payee to whom a certificate of insurance has been issued.
- B. Owner shall purchase and maintain such equipment breakdown insurance or additional property insurance as may be required by the Supplementary Conditions or Laws and Regulations which will include the interests of Owner, Contractor, Subcontractors, and Engineer, and any other individuals or entities identified in the Supplementary Conditions, and the officers, directors, members, partners, employees, agents, consultants and subcontractors of each and any of them, each of whom is deemed to have an insurable interest and shall be listed as a loss payee.
- C. All the policies of insurance (and the certificates or other evidence thereof) required to be purchased and maintained in accordance with this Paragraph 5.06 will contain a provision or endorsement that the coverage afforded will not be canceled or materially changed or renewal refused until at least 30 days prior written notice has been given to Owner and Contractor and to each other loss payee to whom a certificate of insurance has been issued and will contain waiver provisions in accordance with Paragraph 5.07.
- D. Owner shall not be responsible for purchasing and maintaining any property insurance specified in this Paragraph 5.06 to protect the interests of Contractor, Subcontractors, or others in the Work to the extent of any deductible amounts that are identified in the Supplementary Conditions. The risk of loss within such identified deductible amount will be borne by Contractor, Subcontractors, or others suffering any such loss, and if any of them wishes property insurance coverage within the limits of such amounts, each may purchase and maintain it at the purchaser's own expense.

- E. If Contractor requests in writing that other special insurance be included in the property insurance policies provided under this Paragraph 5.06, Owner shall, if possible, include such insurance, and the cost thereof will be charged to Contractor by appropriate Change Order. Prior to commencement of the Work at the Site, Owner shall in writing advise Contractor whether or not such other insurance has been procured by Owner.

5.07 *Waiver of Rights*

- A. Owner and Contractor intend that all policies purchased in accordance with Paragraph 5.06 will protect Owner, Contractor, Subcontractors, and Engineer, and all other individuals or entities identified in the Supplementary Conditions as loss payees (and the officers, directors, members, partners, employees, agents, consultants, and subcontractors of each and any of them) in such policies and will provide primary coverage for all losses and damages caused by the perils or causes of loss covered thereby. All such policies shall contain provisions to the effect that in the event of payment of any loss or damage the insurers will have no rights of recovery against any of the insureds or loss payees thereunder. Owner and Contractor waive all rights against each other and their respective officers, directors, members, partners, employees, agents, consultants and subcontractors of each and any of them for all losses and damages caused by, arising out of or resulting from any of the perils or causes of loss covered by such policies and any other property insurance applicable to the Work; and, in addition, waive all such rights against Subcontractors and Engineer, and all other individuals or entities identified in the Supplementary Conditions as loss payees (and the officers, directors, members, partners, employees, agents, consultants, and subcontractors of each and any of them) under such policies for losses and damages so caused. None of the above waivers shall extend to the rights that any party making such waiver may have to the proceeds of insurance held by Owner as trustee or otherwise payable under any policy so issued.
- B. Owner waives all rights against Contractor, Subcontractors, and Engineer, and the officers, directors, members, partners, employees, agents, consultants and subcontractors of each and any of them for:
1. loss due to business interruption, loss of use, or other consequential loss extending beyond direct physical loss or damage to Owner's property or the Work caused by, arising out of, or resulting from fire or other perils whether or not insured by Owner; and
 2. loss or damage to the completed Project or part thereof caused by, arising out of, or resulting from fire or other insured peril or cause of loss covered by any property insurance maintained on the completed Project or part thereof by Owner during partial utilization pursuant to Paragraph 14.05, after Substantial Completion pursuant to Paragraph 14.04, or after final payment pursuant to Paragraph 14.07.
- C. Any insurance policy maintained by Owner covering any loss, damage or consequential loss referred to in Paragraph 5.07.B shall contain provisions to the effect that in the event of payment of any such loss, damage, or consequential loss, the insurers will have no rights of recovery against Contractor, Subcontractors, or Engineer, and the officers, directors, members, partners, employees, agents, consultants and subcontractors of each and any of them.

5.08 *Receipt and Application of Insurance Proceeds*

- A. Any insured loss under the policies of insurance required by Paragraph 5.06 will be adjusted with Owner and made payable to Owner as fiduciary for the loss payees, as their interests may appear, subject to the requirements of any applicable mortgage clause and of Paragraph 5.08.B. Owner shall deposit in a separate account any money so received and shall distribute it in accordance with such agreement as the parties in interest may reach. If no other special agreement is reached, the damaged Work shall be repaired or replaced, the moneys so received applied on account thereof, and the Work and the cost thereof covered by an appropriate Change Order.
- B. Owner as fiduciary shall have power to adjust and settle any loss with the insurers unless one of the parties in interest shall object in writing within 15 days after the occurrence of loss to Owner's exercise of this power. If such objection be made, Owner as fiduciary shall make settlement with the insurers in accordance with such agreement as the parties in interest may reach. If no such agreement among the parties in interest is reached, Owner as fiduciary shall adjust and settle the loss with the insurers and, if required in writing by any party in interest, Owner as fiduciary shall give bond for the proper performance of such duties.

5.09 *Acceptance of Bonds and Insurance; Option to Replace*

- A. If either Owner or Contractor has any objection to the coverage afforded by or other provisions of the bonds or insurance required to be purchased and maintained by the other party in accordance with Article 5 on the basis of non-conformance with the Contract Documents, the objecting party shall so notify the other party in writing within 10 days after receipt of the certificates (or other evidence requested) required by Paragraph 2.01.B. Owner and Contractor shall each provide to the other such additional information in respect of insurance provided as the other may reasonably request. If either party does not purchase or maintain all of the bonds and insurance required of such party by the Contract Documents, such party shall notify the other party in writing of such failure to purchase prior to the start of the Work, or of such failure to maintain prior to any change in the required coverage. Without prejudice to any other right or remedy, the other party may elect to obtain equivalent bonds or insurance to protect such other party's interests at the expense of the party who was required to provide such coverage, and a Change Order shall be issued to adjust the Contract Price accordingly.

5.10 *Partial Utilization, Acknowledgment of Property Insurer*

- A. If Owner finds it necessary to occupy or use a portion or portions of the Work prior to Substantial Completion of all the Work as provided in Paragraph 14.05, no such use or occupancy shall commence before the insurers providing the property insurance pursuant to Paragraph 5.06 have acknowledged notice thereof and in writing effected any changes in coverage necessitated thereby. The insurers providing the property insurance shall consent by endorsement on the policy or policies, but the property insurance shall not be canceled or permitted to lapse on account of any such partial use or occupancy.

ARTICLE 6 – CONTRACTOR’S RESPONSIBILITIES

6.01 *Supervision and Superintendence*

- A. Contractor shall supervise, inspect, and direct the Work competently and efficiently, devoting such attention thereto and applying such skills and expertise as may be necessary to perform the Work in accordance with the Contract Documents. Contractor shall be solely responsible for the means, methods, techniques, sequences, and procedures of construction. Contractor shall not be responsible for the negligence of Owner or Engineer in the design or specification of a specific means, method, technique, sequence, or procedure of construction which is shown or indicated in and expressly required by the Contract Documents.
- B. At all times during the progress of the Work, Contractor shall assign a competent resident superintendent who shall not be replaced without written notice to Owner and Engineer except under extraordinary circumstances.

6.02 *Labor; Working Hours*

- A. Contractor shall provide competent, suitably qualified personnel to survey and lay out the Work and perform construction as required by the Contract Documents. Contractor shall at all times maintain good discipline and order at the Site.
- B. Except as otherwise required for the safety or protection of persons or the Work or property at the Site or adjacent thereto, and except as otherwise stated in the Contract Documents, all Work at the Site shall be performed during regular working hours. Contractor will not permit the performance of Work on a Saturday, Sunday, or any legal holiday without Owner’s written consent (which will not be unreasonably withheld) given after prior written notice to Engineer.

6.03 *Services, Materials, and Equipment*

- A. Unless otherwise specified in the Contract Documents, Contractor shall provide and assume full responsibility for all services, materials, equipment, labor, transportation, construction equipment and machinery, tools, appliances, fuel, power, light, heat, telephone, water, sanitary facilities, temporary facilities, and all other facilities and incidentals necessary for the performance, testing, start-up, and completion of the Work.
- B. All materials and equipment incorporated into the Work shall be as specified or, if not specified, shall be of good quality and new, except as otherwise provided in the Contract Documents. All special warranties and guarantees required by the Specifications shall expressly run to the benefit of Owner. If required by Engineer, Contractor shall furnish satisfactory evidence (including reports of required tests) as to the source, kind, and quality of materials and equipment.
- C. All materials and equipment shall be stored, applied, installed, connected, erected, protected, used, cleaned, and conditioned in accordance with instructions of the applicable Supplier, except as otherwise may be provided in the Contract Documents.

6.04 *Progress Schedule*

- A. Contractor shall adhere to the Progress Schedule established in accordance with Paragraph 2.07 as it may be adjusted from time to time as provided below.
1. Contractor shall submit to Engineer for acceptance (to the extent indicated in Paragraph 2.07) proposed adjustments in the Progress Schedule that will not result in changing the Contract Times. Such adjustments will comply with any provisions of the General Requirements applicable thereto.
 2. Proposed adjustments in the Progress Schedule that will change the Contract Times shall be submitted in accordance with the requirements of Article 12. Adjustments in Contract Times may only be made by a Change Order.

6.05 *Substitutes and "Or-Equals"*

- A. Whenever an item of material or equipment is specified or described in the Contract Documents by using the name of a proprietary item or the name of a particular Supplier, the specification or description is intended to establish the type, function, appearance, and quality required. Unless the specification or description contains or is followed by words reading that no like, equivalent, or "or-equal" item or no substitution is permitted, other items of material or equipment or material or equipment of other Suppliers may be submitted to Engineer for review under the circumstances described below.
1. *"Or-Equal" Items:* If in Engineer's sole discretion an item of material or equipment proposed by Contractor is functionally equal to that named and sufficiently similar so that no change in related Work will be required, it may be considered by Engineer as an "or-equal" item, in which case review and approval of the proposed item may, in Engineer's sole discretion, be accomplished without compliance with some or all of the requirements for approval of proposed substitute items. For the purposes of this Paragraph 6.05.A.1, a proposed item of material or equipment will be considered functionally equal to an item so named if:
 - a. in the exercise of reasonable judgment Engineer determines that:
 - 1) it is at least equal in materials of construction, quality, durability, appearance, strength, and design characteristics;
 - 2) it will reliably perform at least equally well the function and achieve the results imposed by the design concept of the completed Project as a functioning whole; and
 - 3) it has a proven record of performance and availability of responsive service.
 - b. Contractor certifies that, if approved and incorporated into the Work:
 - 1) there will be no increase in cost to the Owner or increase in Contract Times; and
 - 2) it will conform substantially to the detailed requirements of the item named in the Contract Documents.

2. *Substitute Items:*

- a. If in Engineer's sole discretion an item of material or equipment proposed by Contractor does not qualify as an "or-equal" item under Paragraph 6.05.A.1, it will be considered a proposed substitute item.
- b. Contractor shall submit sufficient information as provided below to allow Engineer to determine if the item of material or equipment proposed is essentially equivalent to that named and an acceptable substitute therefor. Requests for review of proposed substitute items of material or equipment will not be accepted by Engineer from anyone other than Contractor.
- c. The requirements for review by Engineer will be as set forth in Paragraph 6.05.A.2.d, as supplemented by the General Requirements, and as Engineer may decide is appropriate under the circumstances.
- d. Contractor shall make written application to Engineer for review of a proposed substitute item of material or equipment that Contractor seeks to furnish or use. The application:
 - 1) shall certify that the proposed substitute item will:
 - a) perform adequately the functions and achieve the results called for by the general design,
 - b) be similar in substance to that specified, and
 - c) be suited to the same use as that specified;
 - 2) will state:
 - a) the extent, if any, to which the use of the proposed substitute item will prejudice Contractor's achievement of Substantial Completion on time,
 - b) whether use of the proposed substitute item in the Work will require a change in any of the Contract Documents (or in the provisions of any other direct contract with Owner for other work on the Project) to adapt the design to the proposed substitute item, and
 - c) whether incorporation or use of the proposed substitute item in connection with the Work is subject to payment of any license fee or royalty;
 - 3) will identify:
 - a) all variations of the proposed substitute item from that specified, and
 - b) available engineering, sales, maintenance, repair, and replacement services; and
 - 4) shall contain an itemized estimate of all costs or credits that will result directly or indirectly from use of such substitute item, including costs of redesign and claims of other contractors affected by any resulting change.

- B. *Substitute Construction Methods or Procedures:* If a specific means, method, technique, sequence, or procedure of construction is expressly required by the Contract Documents, Contractor may furnish or utilize a substitute means, method, technique, sequence, or procedure of construction approved by Engineer. Contractor shall submit sufficient information to allow Engineer, in Engineer's sole discretion, to determine that the substitute proposed is equivalent to that expressly called for by the Contract Documents. The requirements for review by Engineer will be similar to those provided in Paragraph 6.05.A.2.
- C. *Engineer's Evaluation:* Engineer will be allowed a reasonable time within which to evaluate each proposal or submittal made pursuant to Paragraphs 6.05.A and 6.05.B. Engineer may require Contractor to furnish additional data about the proposed substitute item. Engineer will be the sole judge of acceptability. No "or equal" or substitute will be ordered, installed or utilized until Engineer's review is complete, which will be evidenced by a Change Order in the case of a substitute and an approved Shop Drawing for an "or equal." Engineer will advise Contractor in writing of any negative determination.
- D. *Special Guarantee:* Owner may require Contractor to furnish at Contractor's expense a special performance guarantee or other surety with respect to any substitute.
- E. *Engineer's Cost Reimbursement:* Engineer will record Engineer's costs in evaluating a substitute proposed or submitted by Contractor pursuant to Paragraphs 6.05.A.2 and 6.05.B. Whether or not Engineer approves a substitute so proposed or submitted by Contractor, Contractor shall reimburse Owner for the reasonable charges of Engineer for evaluating each such proposed substitute. Contractor shall also reimburse Owner for the reasonable charges of Engineer for making changes in the Contract Documents (or in the provisions of any other direct contract with Owner) resulting from the acceptance of each proposed substitute.
- F. *Contractor's Expense:* Contractor shall provide all data in support of any proposed substitute or "or-equal" at Contractor's expense.

6.06 *Concerning Subcontractors, Suppliers, and Others*

- A. Contractor shall not employ any Subcontractor, Supplier, or other individual or entity (including those acceptable to Owner as indicated in Paragraph 6.06.B), whether initially or as a replacement, against whom Owner may have reasonable objection. Contractor shall not be required to employ any Subcontractor, Supplier, or other individual or entity to furnish or perform any of the Work against whom Contractor has reasonable objection.
- B. If the Supplementary Conditions require the identity of certain Subcontractors, Suppliers, or other individuals or entities to be submitted to Owner in advance for acceptance by Owner by a specified date prior to the Effective Date of the Agreement, and if Contractor has submitted a list thereof in accordance with the Supplementary Conditions, Owner's acceptance (either in writing or by failing to make written objection thereto by the date indicated for acceptance or objection in the Bidding Documents or the Contract Documents) of any such Subcontractor, Supplier, or other individual or entity so identified may be revoked on the basis of reasonable objection after due investigation. Contractor shall submit an acceptable replacement for the rejected Subcontractor, Supplier, or other individual or entity, and the Contract Price will be adjusted by the difference in the cost occasioned by such replacement, and an appropriate Change Order will be issued. No acceptance by Owner of any such Subcontractor, Supplier, or other individual or

entity, whether initially or as a replacement, shall constitute a waiver of any right of Owner or Engineer to reject defective Work.

- C. Contractor shall be fully responsible to Owner and Engineer for all acts and omissions of the Subcontractors, Suppliers, and other individuals or entities performing or furnishing any of the Work just as Contractor is responsible for Contractor's own acts and omissions. Nothing in the Contract Documents:
1. shall create for the benefit of any such Subcontractor, Supplier, or other individual or entity any contractual relationship between Owner or Engineer and any such Subcontractor, Supplier or other individual or entity; nor
 2. shall create any obligation on the part of Owner or Engineer to pay or to see to the payment of any moneys due any such Subcontractor, Supplier, or other individual or entity except as may otherwise be required by Laws and Regulations.
- D. Contractor shall be solely responsible for scheduling and coordinating the Work of Subcontractors, Suppliers, and other individuals or entities performing or furnishing any of the Work under a direct or indirect contract with Contractor.
- E. Contractor shall require all Subcontractors, Suppliers, and such other individuals or entities performing or furnishing any of the Work to communicate with Engineer through Contractor.
- F. The divisions and sections of the Specifications and the identifications of any Drawings shall not control Contractor in dividing the Work among Subcontractors or Suppliers or delineating the Work to be performed by any specific trade.
- G. All Work performed for Contractor by a Subcontractor or Supplier will be pursuant to an appropriate agreement between Contractor and the Subcontractor or Supplier which specifically binds the Subcontractor or Supplier to the applicable terms and conditions of the Contract Documents for the benefit of Owner and Engineer. Whenever any such agreement is with a Subcontractor or Supplier who is listed as a loss payee on the property insurance provided in Paragraph 5.06, the agreement between the Contractor and the Subcontractor or Supplier will contain provisions whereby the Subcontractor or Supplier waives all rights against Owner, Contractor, Engineer, and all other individuals or entities identified in the Supplementary Conditions to be listed as insureds or loss payees (and the officers, directors, members, partners, employees, agents, consultants, and subcontractors of each and any of them) for all losses and damages caused by, arising out of, relating to, or resulting from any of the perils or causes of loss covered by such policies and any other property insurance applicable to the Work. If the insurers on any such policies require separate waiver forms to be signed by any Subcontractor or Supplier, Contractor will obtain the same.

6.07 *Patent Fees and Royalties*

- A. Contractor shall pay all license fees and royalties and assume all costs incident to the use in the performance of the Work or the incorporation in the Work of any invention, design, process, product, or device which is the subject of patent rights or copyrights held by others. If a particular invention, design, process, product, or device is specified in the Contract Documents for use in the performance of the Work and if, to the actual knowledge of Owner or Engineer, its

use is subject to patent rights or copyrights calling for the payment of any license fee or royalty to others, the existence of such rights shall be disclosed by Owner in the Contract Documents.

- B. To the fullest extent permitted by Laws and Regulations, Owner shall indemnify and hold harmless Contractor, and its officers, directors, members, partners, employees, agents, consultants, and subcontractors from and against all claims, costs, losses, and damages (including but not limited to all fees and charges of engineers, architects, attorneys, and other professionals, and all court or arbitration or other dispute resolution costs) arising out of or relating to any infringement of patent rights or copyrights incident to the use in the performance of the Work or resulting from the incorporation in the Work of any invention, design, process, product, or device specified in the Contract Documents, but not identified as being subject to payment of any license fee or royalty to others required by patent rights or copyrights.
- C. To the fullest extent permitted by Laws and Regulations, Contractor shall indemnify and hold harmless Owner and Engineer, and the officers, directors, members, partners, employees, agents, consultants and subcontractors of each and any of them from and against all claims, costs, losses, and damages (including but not limited to all fees and charges of engineers, architects, attorneys, and other professionals and all court or arbitration or other dispute resolution costs) arising out of or relating to any infringement of patent rights or copyrights incident to the use in the performance of the Work or resulting from the incorporation in the Work of any invention, design, process, product, or device not specified in the Contract Documents.

6.08 *Permits*

- A. Unless otherwise provided in the Supplementary Conditions, Contractor shall obtain and pay for all construction permits and licenses. Owner shall assist Contractor, when necessary, in obtaining such permits and licenses. Contractor shall pay all governmental charges and inspection fees necessary for the prosecution of the Work which are applicable at the time of opening of Bids, or, if there are no Bids, on the Effective Date of the Agreement. Owner shall pay all charges of utility owners for connections for providing permanent service to the Work.

6.09 *Laws and Regulations*

- A. Contractor shall give all notices required by and shall comply with all Laws and Regulations applicable to the performance of the Work. Except where otherwise expressly required by applicable Laws and Regulations, neither Owner nor Engineer shall be responsible for monitoring Contractor's compliance with any Laws or Regulations.
- B. If Contractor performs any Work knowing or having reason to know that it is contrary to Laws or Regulations, Contractor shall bear all claims, costs, losses, and damages (including but not limited to all fees and charges of engineers, architects, attorneys, and other professionals and all court or arbitration or other dispute resolution costs) arising out of or relating to such Work. However, it shall not be Contractor's responsibility to make certain that the Specifications and Drawings are in accordance with Laws and Regulations, but this shall not relieve Contractor of Contractor's obligations under Paragraph 3.03.
- C. Changes in Laws or Regulations not known at the time of opening of Bids (or, on the Effective Date of the Agreement if there were no Bids) having an effect on the cost or time of performance of the Work shall be the subject of an adjustment in Contract Price or Contract Times. If Owner

and Contractor are unable to agree on entitlement to or on the amount or extent, if any, of any such adjustment, a Claim may be made therefor as provided in Paragraph 10.05.

6.10 *Taxes*

- A. Contractor shall pay all sales, consumer, use, and other similar taxes required to be paid by Contractor in accordance with the Laws and Regulations of the place of the Project which are applicable during the performance of the Work.

6.11 *Use of Site and Other Areas*

A. *Limitation on Use of Site and Other Areas:*

1. Contractor shall confine construction equipment, the storage of materials and equipment, and the operations of workers to the Site and other areas permitted by Laws and Regulations, and shall not unreasonably encumber the Site and other areas with construction equipment or other materials or equipment. Contractor shall assume full responsibility for any damage to any such land or area, or to the owner or occupant thereof, or of any adjacent land or areas resulting from the performance of the Work.
2. Should any claim be made by any such owner or occupant because of the performance of the Work, Contractor shall promptly settle with such other party by negotiation or otherwise resolve the claim by arbitration or other dispute resolution proceeding or at law.
3. To the fullest extent permitted by Laws and Regulations, Contractor shall indemnify and hold harmless Owner and Engineer, and the officers, directors, members, partners, employees, agents, consultants and subcontractors of each and any of them from and against all claims, costs, losses, and damages (including but not limited to all fees and charges of engineers, architects, attorneys, and other professionals and all court or arbitration or other dispute resolution costs) arising out of or relating to any claim or action, legal or equitable, brought by any such owner or occupant against Owner, Engineer, or any other party indemnified hereunder to the extent caused by or based upon Contractor's performance of the Work.

B. *Removal of Debris During Performance of the Work:* During the progress of the Work Contractor shall keep the Site and other areas free from accumulations of waste materials, rubbish, and other debris. Removal and disposal of such waste materials, rubbish, and other debris shall conform to applicable Laws and Regulations.

C. *Cleaning:* Prior to Substantial Completion of the Work Contractor shall clean the Site and the Work and make it ready for utilization by Owner. At the completion of the Work Contractor shall remove from the Site all tools, appliances, construction equipment and machinery, and surplus materials and shall restore to original condition all property not designated for alteration by the Contract Documents.

D. *Loading Structures:* Contractor shall not load nor permit any part of any structure to be loaded in any manner that will endanger the structure, nor shall Contractor subject any part of the Work or adjacent property to stresses or pressures that will endanger it.

6.12 *Record Documents*

- A. Contractor shall maintain in a safe place at the Site one record copy of all Drawings, Specifications, Addenda, Change Orders, Work Change Directives, Field Orders, and written interpretations and clarifications in good order and annotated to show changes made during construction. These record documents together with all approved Samples and a counterpart of all approved Shop Drawings will be available to Engineer for reference. Upon completion of the Work, these record documents, Samples, and Shop Drawings will be delivered to Engineer for Owner.

6.13 *Safety and Protection*

- A. Contractor shall be solely responsible for initiating, maintaining and supervising all safety precautions and programs in connection with the Work. Such responsibility does not relieve Subcontractors of their responsibility for the safety of persons or property in the performance of their work, nor for compliance with applicable safety Laws and Regulations. Contractor shall take all necessary precautions for the safety of, and shall provide the necessary protection to prevent damage, injury or loss to:
 - 1. all persons on the Site or who may be affected by the Work;
 - 2. all the Work and materials and equipment to be incorporated therein, whether in storage on or off the Site; and
 - 3. other property at the Site or adjacent thereto, including trees, shrubs, lawns, walks, pavements, roadways, structures, utilities, and Underground Facilities not designated for removal, relocation, or replacement in the course of construction.
- B. Contractor shall comply with all applicable Laws and Regulations relating to the safety of persons or property, or to the protection of persons or property from damage, injury, or loss; and shall erect and maintain all necessary safeguards for such safety and protection. Contractor shall notify owners of adjacent property and of Underground Facilities and other utility owners when prosecution of the Work may affect them, and shall cooperate with them in the protection, removal, relocation, and replacement of their property.
- C. Contractor shall comply with the applicable requirements of Owner's safety programs, if any. The Supplementary Conditions identify any Owner's safety programs that are applicable to the Work.
- D. Contractor shall inform Owner and Engineer of the specific requirements of Contractor's safety program with which Owner's and Engineer's employees and representatives must comply while at the Site.
- E. All damage, injury, or loss to any property referred to in Paragraph 6.13.A.2 or 6.13.A.3 caused, directly or indirectly, in whole or in part, by Contractor, any Subcontractor, Supplier, or any other individual or entity directly or indirectly employed by any of them to perform any of the Work, or anyone for whose acts any of them may be liable, shall be remedied by Contractor (except damage or loss attributable to the fault of Drawings or Specifications or to the acts or omissions of Owner or Engineer or anyone employed by any of them, or anyone for whose acts

any of them may be liable, and not attributable, directly or indirectly, in whole or in part, to the fault or negligence of Contractor or any Subcontractor, Supplier, or other individual or entity directly or indirectly employed by any of them).

- F. Contractor's duties and responsibilities for safety and for protection of the Work shall continue until such time as all the Work is completed and Engineer has issued a notice to Owner and Contractor in accordance with Paragraph 14.07.B that the Work is acceptable (except as otherwise expressly provided in connection with Substantial Completion).

6.14 *Safety Representative*

- A. Contractor shall designate a qualified and experienced safety representative at the Site whose duties and responsibilities shall be the prevention of accidents and the maintaining and supervising of safety precautions and programs.

6.15 *Hazard Communication Programs*

- A. Contractor shall be responsible for coordinating any exchange of material safety data sheets or other hazard communication information required to be made available to or exchanged between or among employers at the Site in accordance with Laws or Regulations.

6.16 *Emergencies*

- A. In emergencies affecting the safety or protection of persons or the Work or property at the Site or adjacent thereto, Contractor is obligated to act to prevent threatened damage, injury, or loss. Contractor shall give Engineer prompt written notice if Contractor believes that any significant changes in the Work or variations from the Contract Documents have been caused thereby or are required as a result thereof. If Engineer determines that a change in the Contract Documents is required because of the action taken by Contractor in response to such an emergency, a Work Change Directive or Change Order will be issued.

6.17 *Shop Drawings and Samples*

- A. Contractor shall submit Shop Drawings and Samples to Engineer for review and approval in accordance with the accepted Schedule of Submittals (as required by Paragraph 2.07). Each submittal will be identified as Engineer may require.

1. *Shop Drawings:*

- a. Submit number of copies specified in the General Requirements.
- b. Data shown on the Shop Drawings will be complete with respect to quantities, dimensions, specified performance and design criteria, materials, and similar data to show Engineer the services, materials, and equipment Contractor proposes to provide and to enable Engineer to review the information for the limited purposes required by Paragraph 6.17.D.

2. *Samples:*

- a. Submit number of Samples specified in the Specifications.

- b. Clearly identify each Sample as to material, Supplier, pertinent data such as catalog numbers, the use for which intended and other data as Engineer may require to enable Engineer to review the submittal for the limited purposes required by Paragraph 6.17.D.
- B. Where a Shop Drawing or Sample is required by the Contract Documents or the Schedule of Submittals, any related Work performed prior to Engineer's review and approval of the pertinent submittal will be at the sole expense and responsibility of Contractor.

C. *Submittal Procedures:*

1. Before submitting each Shop Drawing or Sample, Contractor shall have:
 - a. reviewed and coordinated each Shop Drawing or Sample with other Shop Drawings and Samples and with the requirements of the Work and the Contract Documents;
 - b. determined and verified all field measurements, quantities, dimensions, specified performance and design criteria, installation requirements, materials, catalog numbers, and similar information with respect thereto;
 - c. determined and verified the suitability of all materials offered with respect to the indicated application, fabrication, shipping, handling, storage, assembly, and installation pertaining to the performance of the Work; and
 - d. determined and verified all information relative to Contractor's responsibilities for means, methods, techniques, sequences, and procedures of construction, and safety precautions and programs incident thereto.
2. Each submittal shall bear a stamp or specific written certification that Contractor has satisfied Contractor's obligations under the Contract Documents with respect to Contractor's review and approval of that submittal.
3. With each submittal, Contractor shall give Engineer specific written notice of any variations that the Shop Drawing or Sample may have from the requirements of the Contract Documents. This notice shall be both a written communication separate from the Shop Drawings or Sample submittal; and, in addition, by a specific notation made on each Shop Drawing or Sample submitted to Engineer for review and approval of each such variation.

D. *Engineer's Review:*

1. Engineer will provide timely review of Shop Drawings and Samples in accordance with the Schedule of Submittals acceptable to Engineer. Engineer's review and approval will be only to determine if the items covered by the submittals will, after installation or incorporation in the Work, conform to the information given in the Contract Documents and be compatible with the design concept of the completed Project as a functioning whole as indicated by the Contract Documents.
2. Engineer's review and approval will not extend to means, methods, techniques, sequences, or procedures of construction (except where a particular means, method, technique, sequence, or procedure of construction is specifically and expressly called for by the

Contract Documents) or to safety precautions or programs incident thereto. The review and approval of a separate item as such will not indicate approval of the assembly in which the item functions.

3. Engineer's review and approval shall not relieve Contractor from responsibility for any variation from the requirements of the Contract Documents unless Contractor has complied with the requirements of Paragraph 6.17.C.3 and Engineer has given written approval of each such variation by specific written notation thereof incorporated in or accompanying the Shop Drawing or Sample. Engineer's review and approval shall not relieve Contractor from responsibility for complying with the requirements of Paragraph 6.17.C.1.

E. *Resubmittal Procedures:*

1. Contractor shall make corrections required by Engineer and shall return the required number of corrected copies of Shop Drawings and submit, as required, new Samples for review and approval. Contractor shall direct specific attention in writing to revisions other than the corrections called for by Engineer on previous submittals.

6.18 *Continuing the Work*

- A. Contractor shall carry on the Work and adhere to the Progress Schedule during all disputes or disagreements with Owner. No Work shall be delayed or postponed pending resolution of any disputes or disagreements, except as permitted by Paragraph 15.04 or as Owner and Contractor may otherwise agree in writing.

6.19 *Contractor's General Warranty and Guarantee*

- A. Contractor warrants and guarantees to Owner that all Work will be in accordance with the Contract Documents and will not be defective. Engineer and its officers, directors, members, partners, employees, agents, consultants, and subcontractors shall be entitled to rely on representation of Contractor's warranty and guarantee.
- B. Contractor's warranty and guarantee hereunder excludes defects or damage caused by:
 1. abuse, modification, or improper maintenance or operation by persons other than Contractor, Subcontractors, Suppliers, or any other individual or entity for whom Contractor is responsible; or
 2. normal wear and tear under normal usage.
- C. Contractor's obligation to perform and complete the Work in accordance with the Contract Documents shall be absolute. None of the following will constitute an acceptance of Work that is not in accordance with the Contract Documents or a release of Contractor's obligation to perform the Work in accordance with the Contract Documents:
 1. observations by Engineer;
 2. recommendation by Engineer or payment by Owner of any progress or final payment;

3. the issuance of a certificate of Substantial Completion by Engineer or any payment related thereto by Owner;
4. use or occupancy of the Work or any part thereof by Owner;
5. any review and approval of a Shop Drawing or Sample submittal or the issuance of a notice of acceptability by Engineer;
6. any inspection, test, or approval by others; or
7. any correction of defective Work by Owner.

6.20 *Indemnification*

- A. To the fullest extent permitted by Laws and Regulations, Contractor shall indemnify and hold harmless Owner and Engineer, and the officers, directors, members, partners, employees, agents, consultants and subcontractors of each and any of them from and against all claims, costs, losses, and damages (including but not limited to all fees and charges of engineers, architects, attorneys, and other professionals and all court or arbitration or other dispute resolution costs) arising out of or relating to the performance of the Work, provided that any such claim, cost, loss, or damage is attributable to bodily injury, sickness, disease, or death, or to injury to or destruction of tangible property (other than the Work itself), including the loss of use resulting therefrom but only to the extent caused by any negligent act or omission of Contractor, any Subcontractor, any Supplier, or any individual or entity directly or indirectly employed by any of them to perform any of the Work or anyone for whose acts any of them may be liable .
- B. In any and all claims against Owner or Engineer or any of their officers, directors, members, partners, employees, agents, consultants, or subcontractors by any employee (or the survivor or personal representative of such employee) of Contractor, any Subcontractor, any Supplier, or any individual or entity directly or indirectly employed by any of them to perform any of the Work, or anyone for whose acts any of them may be liable, the indemnification obligation under Paragraph 6.20.A shall not be limited in any way by any limitation on the amount or type of damages, compensation, or benefits payable by or for Contractor or any such Subcontractor, Supplier, or other individual or entity under workers' compensation acts, disability benefit acts, or other employee benefit acts.
- C. The indemnification obligations of Contractor under Paragraph 6.20.A shall not extend to the liability of Engineer and Engineer's officers, directors, members, partners, employees, agents, consultants and subcontractors arising out of:
 1. the preparation or approval of, or the failure to prepare or approve maps, Drawings, opinions, reports, surveys, Change Orders, designs, or Specifications; or
 2. giving directions or instructions, or failing to give them, if that is the primary cause of the injury or damage.

6.21 *Delegation of Professional Design Services*

- A. Contractor will not be required to provide professional design services unless such services are specifically required by the Contract Documents for a portion of the Work or unless such services are required to carry out Contractor's responsibilities for construction means, methods, techniques, sequences and procedures. Contractor shall not be required to provide professional services in violation of applicable law.
- B. If professional design services or certifications by a design professional related to systems, materials or equipment are specifically required of Contractor by the Contract Documents, Owner and Engineer will specify all performance and design criteria that such services must satisfy. Contractor shall cause such services or certifications to be provided by a properly licensed professional, whose signature and seal shall appear on all drawings, calculations, specifications, certifications, Shop Drawings and other submittals prepared by such professional. Shop Drawings and other submittals related to the Work designed or certified by such professional, if prepared by others, shall bear such professional's written approval when submitted to Engineer.
- C. Owner and Engineer shall be entitled to rely upon the adequacy, accuracy and completeness of the services, certifications or approvals performed by such design professionals, provided Owner and Engineer have specified to Contractor all performance and design criteria that such services must satisfy.
- D. Pursuant to this Paragraph 6.21, Engineer's review and approval of design calculations and design drawings will be only for the limited purpose of checking for conformance with performance and design criteria given and the design concept expressed in the Contract Documents. Engineer's review and approval of Shop Drawings and other submittals (except design calculations and design drawings) will be only for the purpose stated in Paragraph 6.17.D.1.
- E. Contractor shall not be responsible for the adequacy of the performance or design criteria required by the Contract Documents.

ARTICLE 7 – OTHER WORK AT THE SITE

7.01 *Related Work at Site*

- A. Owner may perform other work related to the Project at the Site with Owner's employees, or through other direct contracts therefor, or have other work performed by utility owners. If such other work is not noted in the Contract Documents, then:
 - 1. written notice thereof will be given to Contractor prior to starting any such other work; and
 - 2. if Owner and Contractor are unable to agree on entitlement to or on the amount or extent, if any, of any adjustment in the Contract Price or Contract Times that should be allowed as a result of such other work, a Claim may be made therefor as provided in Paragraph 10.05.
- B. Contractor shall afford each other contractor who is a party to such a direct contract, each utility owner, and Owner, if Owner is performing other work with Owner's employees, proper and safe

access to the Site, provide a reasonable opportunity for the introduction and storage of materials and equipment and the execution of such other work, and properly coordinate the Work with theirs. Contractor shall do all cutting, fitting, and patching of the Work that may be required to properly connect or otherwise make its several parts come together and properly integrate with such other work. Contractor shall not endanger any work of others by cutting, excavating, or otherwise altering such work; provided, however, that Contractor may cut or alter others' work with the written consent of Engineer and the others whose work will be affected. The duties and responsibilities of Contractor under this Paragraph are for the benefit of such utility owners and other contractors to the extent that there are comparable provisions for the benefit of Contractor in said direct contracts between Owner and such utility owners and other contractors.

- C. If the proper execution or results of any part of Contractor's Work depends upon work performed by others under this Article 7, Contractor shall inspect such other work and promptly report to Engineer in writing any delays, defects, or deficiencies in such other work that render it unavailable or unsuitable for the proper execution and results of Contractor's Work. Contractor's failure to so report will constitute an acceptance of such other work as fit and proper for integration with Contractor's Work except for latent defects and deficiencies in such other work.

7.02 *Coordination*

- A. If Owner intends to contract with others for the performance of other work on the Project at the Site, the following will be set forth in Supplementary Conditions:
 - 1. the individual or entity who will have authority and responsibility for coordination of the activities among the various contractors will be identified;
 - 2. the specific matters to be covered by such authority and responsibility will be itemized; and
 - 3. the extent of such authority and responsibilities will be provided.
- B. Unless otherwise provided in the Supplementary Conditions, Owner shall have sole authority and responsibility for such coordination.

7.03 *Legal Relationships*

- A. Paragraphs 7.01.A and 7.02 are not applicable for utilities not under the control of Owner.
- B. Each other direct contract of Owner under Paragraph 7.01.A shall provide that the other contractor is liable to Owner and Contractor for the reasonable direct delay and disruption costs incurred by Contractor as a result of the other contractor's wrongful actions or inactions.
- C. Contractor shall be liable to Owner and any other contractor under direct contract to Owner for the reasonable direct delay and disruption costs incurred by such other contractor as a result of Contractor's wrongful action or inactions.

ARTICLE 8 – OWNER’S RESPONSIBILITIES

8.01 *Communications to Contractor*

- A. Except as otherwise provided in these General Conditions, Owner shall issue all communications to Contractor through Engineer.

8.02 *Replacement of Engineer*

- A. In case of termination of the employment of Engineer, Owner shall appoint an engineer to whom Contractor makes no reasonable objection, whose status under the Contract Documents shall be that of the former Engineer.

8.03 *Furnish Data*

- A. Owner shall promptly furnish the data required of Owner under the Contract Documents.

8.04 *Pay When Due*

- A. Owner shall make payments to Contractor when they are due as provided in Paragraphs 14.02.C and 14.07.C.

8.05 *Lands and Easements; Reports and Tests*

- A. Owner’s duties with respect to providing lands and easements and providing engineering surveys to establish reference points are set forth in Paragraphs 4.01 and 4.05. Paragraph 4.02 refers to Owner’s identifying and making available to Contractor copies of reports of explorations and tests of subsurface conditions and drawings of physical conditions relating to existing surface or subsurface structures at the Site.

8.06 *Insurance*

- A. Owner’s responsibilities, if any, with respect to purchasing and maintaining liability and property insurance are set forth in Article 5.

8.07 *Change Orders*

- A. Owner is obligated to execute Change Orders as indicated in Paragraph 10.03.

8.08 *Inspections, Tests, and Approvals*

- A. Owner’s responsibility with respect to certain inspections, tests, and approvals is set forth in Paragraph 13.03.B.

8.09 *Limitations on Owner’s Responsibilities*

- A. The Owner shall not supervise, direct, or have control or authority over, nor be responsible for, Contractor’s means, methods, techniques, sequences, or procedures of construction, or the safety precautions and programs incident thereto, or for any failure of Contractor to comply with Laws

and Regulations applicable to the performance of the Work. Owner will not be responsible for Contractor's failure to perform the Work in accordance with the Contract Documents.

8.10 *Undisclosed Hazardous Environmental Condition*

- A. Owner's responsibility in respect to an undisclosed Hazardous Environmental Condition is set forth in Paragraph 4.06.

8.11 *Evidence of Financial Arrangements*

- A. Upon request of Contractor, Owner shall furnish Contractor reasonable evidence that financial arrangements have been made to satisfy Owner's obligations under the Contract Documents.

8.12 *Compliance with Safety Program*

- A. While at the Site, Owner's employees and representatives shall comply with the specific applicable requirements of Contractor's safety programs of which Owner has been informed pursuant to Paragraph 6.13.D.

ARTICLE 9 – ENGINEER'S STATUS DURING CONSTRUCTION

9.01 *Owner's Representative*

- A. Engineer will be Owner's representative during the construction period. The duties and responsibilities and the limitations of authority of Engineer as Owner's representative during construction are set forth in the Contract Documents.

9.02 *Visits to Site*

- A. Engineer will make visits to the Site at intervals appropriate to the various stages of construction as Engineer deems necessary in order to observe as an experienced and qualified design professional the progress that has been made and the quality of the various aspects of Contractor's executed Work. Based on information obtained during such visits and observations, Engineer, for the benefit of Owner, will determine, in general, if the Work is proceeding in accordance with the Contract Documents. Engineer will not be required to make exhaustive or continuous inspections on the Site to check the quality or quantity of the Work. Engineer's efforts will be directed toward providing for Owner a greater degree of confidence that the completed Work will conform generally to the Contract Documents. On the basis of such visits and observations, Engineer will keep Owner informed of the progress of the Work and will endeavor to guard Owner against defective Work.
- B. Engineer's visits and observations are subject to all the limitations on Engineer's authority and responsibility set forth in Paragraph 9.09. Particularly, but without limitation, during or as a result of Engineer's visits or observations of Contractor's Work, Engineer will not supervise, direct, control, or have authority over or be responsible for Contractor's means, methods, techniques, sequences, or procedures of construction, or the safety precautions and programs incident thereto, or for any failure of Contractor to comply with Laws and Regulations applicable to the performance of the Work.

9.03 *Project Representative*

- A. If Owner and Engineer agree, Engineer will furnish a Resident Project Representative to assist Engineer in providing more extensive observation of the Work. The authority and responsibilities of any such Resident Project Representative and assistants will be as provided in the Supplementary Conditions, and limitations on the responsibilities thereof will be as provided in Paragraph 9.09. If Owner designates another representative or agent to represent Owner at the Site who is not Engineer's consultant, agent or employee, the responsibilities and authority and limitations thereon of such other individual or entity will be as provided in the Supplementary Conditions.

9.04 *Authorized Variations in Work*

- A. Engineer may authorize minor variations in the Work from the requirements of the Contract Documents which do not involve an adjustment in the Contract Price or the Contract Times and are compatible with the design concept of the completed Project as a functioning whole as indicated by the Contract Documents. These may be accomplished by a Field Order and will be binding on Owner and also on Contractor, who shall perform the Work involved promptly. If Owner or Contractor believes that a Field Order justifies an adjustment in the Contract Price or Contract Times, or both, and the parties are unable to agree on entitlement to or on the amount or extent, if any, of any such adjustment, a Claim may be made therefor as provided in Paragraph 10.05.

9.05 *Rejecting Defective Work*

- A. Engineer will have authority to reject Work which Engineer believes to be defective, or that Engineer believes will not produce a completed Project that conforms to the Contract Documents or that will prejudice the integrity of the design concept of the completed Project as a functioning whole as indicated by the Contract Documents. Engineer will also have authority to require special inspection or testing of the Work as provided in Paragraph 13.04, whether or not the Work is fabricated, installed, or completed.

9.06 *Shop Drawings, Change Orders and Payments*

- A. In connection with Engineer's authority, and limitations thereof, as to Shop Drawings and Samples, see Paragraph 6.17.
- B. In connection with Engineer's authority, and limitations thereof, as to design calculations and design drawings submitted in response to a delegation of professional design services, if any, see Paragraph 6.21.
- C. In connection with Engineer's authority as to Change Orders, see Articles 10, 11, and 12.
- D. In connection with Engineer's authority as to Applications for Payment, see Article 14.

9.07 *Determinations for Unit Price Work*

- A. Engineer will determine the actual quantities and classifications of Unit Price Work performed by Contractor. Engineer will review with Contractor the Engineer's preliminary determinations

on such matters before rendering a written decision thereon (by recommendation of an Application for Payment or otherwise). Engineer's written decision thereon will be final and binding (except as modified by Engineer to reflect changed factual conditions or more accurate data) upon Owner and Contractor, subject to the provisions of Paragraph 10.05.

9.08 *Decisions on Requirements of Contract Documents and Acceptability of Work*

- A. Engineer will be the initial interpreter of the requirements of the Contract Documents and judge of the acceptability of the Work thereunder. All matters in question and other matters between Owner and Contractor arising prior to the date final payment is due relating to the acceptability of the Work, and the interpretation of the requirements of the Contract Documents pertaining to the performance of the Work, will be referred initially to Engineer in writing within 30 days of the event giving rise to the question.
- B. Engineer will, with reasonable promptness, render a written decision on the issue referred. If Owner or Contractor believes that any such decision entitles them to an adjustment in the Contract Price or Contract Times or both, a Claim may be made under Paragraph 10.05. The date of Engineer's decision shall be the date of the event giving rise to the issues referenced for the purposes of Paragraph 10.05.B.
- C. Engineer's written decision on the issue referred will be final and binding on Owner and Contractor, subject to the provisions of Paragraph 10.05.
- D. When functioning as interpreter and judge under this Paragraph 9.08, Engineer will not show partiality to Owner or Contractor and will not be liable in connection with any interpretation or decision rendered in good faith in such capacity.

9.09 *Limitations on Engineer's Authority and Responsibilities*

- A. Neither Engineer's authority or responsibility under this Article 9 or under any other provision of the Contract Documents nor any decision made by Engineer in good faith either to exercise or not exercise such authority or responsibility or the undertaking, exercise, or performance of any authority or responsibility by Engineer shall create, impose, or give rise to any duty in contract, tort, or otherwise owed by Engineer to Contractor, any Subcontractor, any Supplier, any other individual or entity, or to any surety for or employee or agent of any of them.
- B. Engineer will not supervise, direct, control, or have authority over or be responsible for Contractor's means, methods, techniques, sequences, or procedures of construction, or the safety precautions and programs incident thereto, or for any failure of Contractor to comply with Laws and Regulations applicable to the performance of the Work. Engineer will not be responsible for Contractor's failure to perform the Work in accordance with the Contract Documents.
- C. Engineer will not be responsible for the acts or omissions of Contractor or of any Subcontractor, any Supplier, or of any other individual or entity performing any of the Work.
- D. Engineer's review of the final Application for Payment and accompanying documentation and all maintenance and operating instructions, schedules, guarantees, bonds, certificates of inspection, tests and approvals, and other documentation required to be delivered by Paragraph 14.07.A will only be to determine generally that their content complies with the requirements of,

and in the case of certificates of inspections, tests, and approvals that the results certified indicate compliance with, the Contract Documents.

- E. The limitations upon authority and responsibility set forth in this Paragraph 9.09 shall also apply to the Resident Project Representative, if any, and assistants, if any.

9.10 *Compliance with Safety Program*

- A. While at the Site, Engineer's employees and representatives shall comply with the specific applicable requirements of Contractor's safety programs of which Engineer has been informed pursuant to Paragraph 6.13.D.

ARTICLE 10 – CHANGES IN THE WORK; CLAIMS

10.01 *Authorized Changes in the Work*

- A. Without invalidating the Contract and without notice to any surety, Owner may, at any time or from time to time, order additions, deletions, or revisions in the Work by a Change Order, or a Work Change Directive. Upon receipt of any such document, Contractor shall promptly proceed with the Work involved which will be performed under the applicable conditions of the Contract Documents (except as otherwise specifically provided).
- B. If Owner and Contractor are unable to agree on entitlement to, or on the amount or extent, if any, of an adjustment in the Contract Price or Contract Times, or both, that should be allowed as a result of a Work Change Directive, a Claim may be made therefor as provided in Paragraph 10.05.

10.02 *Unauthorized Changes in the Work*

- A. Contractor shall not be entitled to an increase in the Contract Price or an extension of the Contract Times with respect to any work performed that is not required by the Contract Documents as amended, modified, or supplemented as provided in Paragraph 3.04, except in the case of an emergency as provided in Paragraph 6.16 or in the case of uncovering Work as provided in Paragraph 13.04.D.

10.03 *Execution of Change Orders*

- A. Owner and Contractor shall execute appropriate Change Orders recommended by Engineer covering:
 - 1. changes in the Work which are: (i) ordered by Owner pursuant to Paragraph 10.01.A, (ii) required because of acceptance of defective Work under Paragraph 13.08.A or Owner's correction of defective Work under Paragraph 13.09, or (iii) agreed to by the parties;
 - 2. changes in the Contract Price or Contract Times which are agreed to by the parties, including any undisputed sum or amount of time for Work actually performed in accordance with a Work Change Directive; and
 - 3. changes in the Contract Price or Contract Times which embody the substance of any written decision rendered by Engineer pursuant to Paragraph 10.05; provided that, in lieu of

executing any such Change Order, an appeal may be taken from any such decision in accordance with the provisions of the Contract Documents and applicable Laws and Regulations, but during any such appeal, Contractor shall carry on the Work and adhere to the Progress Schedule as provided in Paragraph 6.18.A.

10.04 *Notification to Surety*

- A. If the provisions of any bond require notice to be given to a surety of any change affecting the general scope of the Work or the provisions of the Contract Documents (including, but not limited to, Contract Price or Contract Times), the giving of any such notice will be Contractor's responsibility. The amount of each applicable bond will be adjusted to reflect the effect of any such change.

10.05 *Claims*

- A. *Engineer's Decision Required:* All Claims, except those waived pursuant to Paragraph 14.09, shall be referred to the Engineer for decision. A decision by Engineer shall be required as a condition precedent to any exercise by Owner or Contractor of any rights or remedies either may otherwise have under the Contract Documents or by Laws and Regulations in respect of such Claims.
- B. *Notice:* Written notice stating the general nature of each Claim shall be delivered by the claimant to Engineer and the other party to the Contract promptly (but in no event later than 30 days) after the start of the event giving rise thereto. The responsibility to substantiate a Claim shall rest with the party making the Claim. Notice of the amount or extent of the Claim, with supporting data shall be delivered to the Engineer and the other party to the Contract within 60 days after the start of such event (unless Engineer allows additional time for claimant to submit additional or more accurate data in support of such Claim). A Claim for an adjustment in Contract Price shall be prepared in accordance with the provisions of Paragraph 12.01.B. A Claim for an adjustment in Contract Times shall be prepared in accordance with the provisions of Paragraph 12.02.B. Each Claim shall be accompanied by claimant's written statement that the adjustment claimed is the entire adjustment to which the claimant believes it is entitled as a result of said event. The opposing party shall submit any response to Engineer and the claimant within 30 days after receipt of the claimant's last submittal (unless Engineer allows additional time).
- C. *Engineer's Action:* Engineer will review each Claim and, within 30 days after receipt of the last submittal of the claimant or the last submittal of the opposing party, if any, take one of the following actions in writing:
 - 1. deny the Claim in whole or in part;
 - 2. approve the Claim; or
 - 3. notify the parties that the Engineer is unable to resolve the Claim if, in the Engineer's sole discretion, it would be inappropriate for the Engineer to do so. For purposes of further resolution of the Claim, such notice shall be deemed a denial.
- D. In the event that Engineer does not take action on a Claim within said 30 days, the Claim shall be deemed denied.

- E. Engineer's written action under Paragraph 10.05.C or denial pursuant to Paragraphs 10.05.C.3 or 10.05.D will be final and binding upon Owner and Contractor, unless Owner or Contractor invoke the dispute resolution procedure set forth in Article 16 within 30 days of such action or denial.
- F. No Claim for an adjustment in Contract Price or Contract Times will be valid if not submitted in accordance with this Paragraph 10.05.

ARTICLE 11 – COST OF THE WORK; ALLOWANCES; UNIT PRICE WORK

11.01 *Cost of the Work*

- A. *Costs Included:* The term Cost of the Work means the sum of all costs, except those excluded in Paragraph 11.01.B, necessarily incurred and paid by Contractor in the proper performance of the Work. When the value of any Work covered by a Change Order or when a Claim for an adjustment in Contract Price is determined on the basis of Cost of the Work, the costs to be reimbursed to Contractor will be only those additional or incremental costs required because of the change in the Work or because of the event giving rise to the Claim. Except as otherwise may be agreed to in writing by Owner, such costs shall be in amounts no higher than those prevailing in the locality of the Project, shall not include any of the costs itemized in Paragraph 11.01.B, and shall include only the following items:
 - 1. Payroll costs for employees in the direct employ of Contractor in the performance of the Work under schedules of job classifications agreed upon by Owner and Contractor. Such employees shall include, without limitation, superintendents, foremen, and other personnel employed full time on the Work. Payroll costs for employees not employed full time on the Work shall be apportioned on the basis of their time spent on the Work. Payroll costs shall include, but not be limited to, salaries and wages plus the cost of fringe benefits, which shall include social security contributions, unemployment, excise, and payroll taxes, workers' compensation, health and retirement benefits, bonuses, sick leave, vacation and holiday pay applicable thereto. The expenses of performing Work outside of regular working hours, on Saturday, Sunday, or legal holidays, shall be included in the above to the extent authorized by Owner.
 - 2. Cost of all materials and equipment furnished and incorporated in the Work, including costs of transportation and storage thereof, and Suppliers' field services required in connection therewith. All cash discounts shall accrue to Contractor unless Owner deposits funds with Contractor with which to make payments, in which case the cash discounts shall accrue to Owner. All trade discounts, rebates and refunds and returns from sale of surplus materials and equipment shall accrue to Owner, and Contractor shall make provisions so that they may be obtained.
 - 3. Payments made by Contractor to Subcontractors for Work performed by Subcontractors. If required by Owner, Contractor shall obtain competitive bids from subcontractors acceptable to Owner and Contractor and shall deliver such bids to Owner, who will then determine, with the advice of Engineer, which bids, if any, will be acceptable. If any subcontract provides that the Subcontractor is to be paid on the basis of Cost of the Work plus a fee, the Subcontractor's Cost of the Work and fee shall be determined in the same manner as Contractor's Cost of the Work and fee as provided in this Paragraph 11.01.

4. Costs of special consultants (including but not limited to engineers, architects, testing laboratories, surveyors, attorneys, and accountants) employed for services specifically related to the Work.
5. Supplemental costs including the following:
 - a. The proportion of necessary transportation, travel, and subsistence expenses of Contractor's employees incurred in discharge of duties connected with the Work.
 - b. Cost, including transportation and maintenance, of all materials, supplies, equipment, machinery, appliances, office, and temporary facilities at the Site, and hand tools not owned by the workers, which are consumed in the performance of the Work, and cost, less market value, of such items used but not consumed which remain the property of Contractor.
 - c. Rentals of all construction equipment and machinery, and the parts thereof whether rented from Contractor or others in accordance with rental agreements approved by Owner with the advice of Engineer, and the costs of transportation, loading, unloading, assembly, dismantling, and removal thereof. All such costs shall be in accordance with the terms of said rental agreements. The rental of any such equipment, machinery, or parts shall cease when the use thereof is no longer necessary for the Work.
 - d. Sales, consumer, use, and other similar taxes related to the Work, and for which Contractor is liable, as imposed by Laws and Regulations.
 - e. Deposits lost for causes other than negligence of Contractor, any Subcontractor, or anyone directly or indirectly employed by any of them or for whose acts any of them may be liable, and royalty payments and fees for permits and licenses.
 - f. Losses and damages (and related expenses) caused by damage to the Work, not compensated by insurance or otherwise, sustained by Contractor in connection with the performance of the Work (except losses and damages within the deductible amounts of property insurance established in accordance with Paragraph 5.06.D), provided such losses and damages have resulted from causes other than the negligence of Contractor, any Subcontractor, or anyone directly or indirectly employed by any of them or for whose acts any of them may be liable. Such losses shall include settlements made with the written consent and approval of Owner. No such losses, damages, and expenses shall be included in the Cost of the Work for the purpose of determining Contractor's fee.
 - g. The cost of utilities, fuel, and sanitary facilities at the Site.
 - h. Minor expenses such as telegrams, long distance telephone calls, telephone service at the Site, express and courier services, and similar petty cash items in connection with the Work.
 - i. The costs of premiums for all bonds and insurance Contractor is required by the Contract Documents to purchase and maintain.

B. *Costs Excluded:* The term Cost of the Work shall not include any of the following items:

1. Payroll costs and other compensation of Contractor's officers, executives, principals (of partnerships and sole proprietorships), general managers, safety managers, engineers, architects, estimators, attorneys, auditors, accountants, purchasing and contracting agents, expeditors, timekeepers, clerks, and other personnel employed by Contractor, whether at the Site or in Contractor's principal or branch office for general administration of the Work and not specifically included in the agreed upon schedule of job classifications referred to in Paragraph 11.01.A.1 or specifically covered by Paragraph 11.01.A.4, all of which are to be considered administrative costs covered by the Contractor's fee.
 2. Expenses of Contractor's principal and branch offices other than Contractor's office at the Site.
 3. Any part of Contractor's capital expenses, including interest on Contractor's capital employed for the Work and charges against Contractor for delinquent payments.
 4. Costs due to the negligence of Contractor, any Subcontractor, or anyone directly or indirectly employed by any of them or for whose acts any of them may be liable, including but not limited to, the correction of defective Work, disposal of materials or equipment wrongly supplied, and making good any damage to property.
 5. Other overhead or general expense costs of any kind and the costs of any item not specifically and expressly included in Paragraphs 11.01.A.
- C. *Contractor's Fee:* When all the Work is performed on the basis of cost-plus, Contractor's fee shall be determined as set forth in the Agreement. When the value of any Work covered by a Change Order or when a Claim for an adjustment in Contract Price is determined on the basis of Cost of the Work, Contractor's fee shall be determined as set forth in Paragraph 12.01.C.
- D. *Documentation:* Whenever the Cost of the Work for any purpose is to be determined pursuant to Paragraphs 11.01.A and 11.01.B, Contractor will establish and maintain records thereof in accordance with generally accepted accounting practices and submit in a form acceptable to Engineer an itemized cost breakdown together with supporting data.

11.02 Allowances

- A. It is understood that Contractor has included in the Contract Price all allowances so named in the Contract Documents and shall cause the Work so covered to be performed for such sums and by such persons or entities as may be acceptable to Owner and Engineer.
- B. *Cash Allowances:*
1. Contractor agrees that:
 - a. the cash allowances include the cost to Contractor (less any applicable trade discounts) of materials and equipment required by the allowances to be delivered at the Site, and all applicable taxes; and
 - b. Contractor's costs for unloading and handling on the Site, labor, installation, overhead, profit, and other expenses contemplated for the cash allowances have been included in

the Contract Price and not in the allowances, and no demand for additional payment on account of any of the foregoing will be valid.

C. *Contingency Allowance:*

1. Contractor agrees that a contingency allowance, if any, is for the sole use of Owner to cover unanticipated costs.

D. Prior to final payment, an appropriate Change Order will be issued as recommended by Engineer to reflect actual amounts due Contractor on account of Work covered by allowances, and the Contract Price shall be correspondingly adjusted.

11.03 *Unit Price Work*

A. Where the Contract Documents provide that all or part of the Work is to be Unit Price Work, initially the Contract Price will be deemed to include for all Unit Price Work an amount equal to the sum of the unit price for each separately identified item of Unit Price Work times the estimated quantity of each item as indicated in the Agreement.

B. The estimated quantities of items of Unit Price Work are not guaranteed and are solely for the purpose of comparison of Bids and determining an initial Contract Price. Determinations of the actual quantities and classifications of Unit Price Work performed by Contractor will be made by Engineer subject to the provisions of Paragraph 9.07.

C. Each unit price will be deemed to include an amount considered by Contractor to be adequate to cover Contractor's overhead and profit for each separately identified item.

D. Owner or Contractor may make a Claim for an adjustment in the Contract Price in accordance with Paragraph 10.05 if:

1. the quantity of any item of Unit Price Work performed by Contractor differs materially and significantly from the estimated quantity of such item indicated in the Agreement; and
2. there is no corresponding adjustment with respect to any other item of Work; and
3. Contractor believes that Contractor is entitled to an increase in Contract Price as a result of having incurred additional expense or Owner believes that Owner is entitled to a decrease in Contract Price and the parties are unable to agree as to the amount of any such increase or decrease.

ARTICLE 12 – CHANGE OF CONTRACT PRICE; CHANGE OF CONTRACT TIMES

12.01 *Change of Contract Price*

A. The Contract Price may only be changed by a Change Order. Any Claim for an adjustment in the Contract Price shall be based on written notice submitted by the party making the Claim to the Engineer and the other party to the Contract in accordance with the provisions of Paragraph 10.05.

- B. The value of any Work covered by a Change Order or of any Claim for an adjustment in the Contract Price will be determined as follows:
1. where the Work involved is covered by unit prices contained in the Contract Documents, by application of such unit prices to the quantities of the items involved (subject to the provisions of Paragraph 11.03); or
 2. where the Work involved is not covered by unit prices contained in the Contract Documents, by a mutually agreed lump sum (which may include an allowance for overhead and profit not necessarily in accordance with Paragraph 12.01.C.2); or
 3. where the Work involved is not covered by unit prices contained in the Contract Documents and agreement to a lump sum is not reached under Paragraph 12.01.B.2, on the basis of the Cost of the Work (determined as provided in Paragraph 11.01) plus a Contractor's fee for overhead and profit (determined as provided in Paragraph 12.01.C).
- C. *Contractor's Fee*: The Contractor's fee for overhead and profit shall be determined as follows:
1. a mutually acceptable fixed fee; or
 2. if a fixed fee is not agreed upon, then a fee based on the following percentages of the various portions of the Cost of the Work:
 - a. for costs incurred under Paragraphs 11.01.A.1 and 11.01.A.2, the Contractor's fee shall be 15 percent;
 - b. for costs incurred under Paragraph 11.01.A.3, the Contractor's fee shall be five percent;
 - c. where one or more tiers of subcontracts are on the basis of Cost of the Work plus a fee and no fixed fee is agreed upon, the intent of Paragraphs 12.01.C.2.a and 12.01.C.2.b is that the Subcontractor who actually performs the Work, at whatever tier, will be paid a fee of 15 percent of the costs incurred by such Subcontractor under Paragraphs 11.01.A.1 and 11.01.A.2 and that any higher tier Subcontractor and Contractor will each be paid a fee of five percent of the amount paid to the next lower tier Subcontractor;
 - d. no fee shall be payable on the basis of costs itemized under Paragraphs 11.01.A.4, 11.01.A.5, and 11.01.B;
 - e. the amount of credit to be allowed by Contractor to Owner for any change which results in a net decrease in cost will be the amount of the actual net decrease in cost plus a deduction in Contractor's fee by an amount equal to five percent of such net decrease; and
 - f. when both additions and credits are involved in any one change, the adjustment in Contractor's fee shall be computed on the basis of the net change in accordance with Paragraphs 12.01.C.2.a through 12.01.C.2.e, inclusive.

12.02 *Change of Contract Times*

- A. The Contract Times may only be changed by a Change Order. Any Claim for an adjustment in the Contract Times shall be based on written notice submitted by the party making the Claim to the Engineer and the other party to the Contract in accordance with the provisions of Paragraph 10.05.
- B. Any adjustment of the Contract Times covered by a Change Order or any Claim for an adjustment in the Contract Times will be determined in accordance with the provisions of this Article 12.

12.03 *Delays*

- A. Where Contractor is prevented from completing any part of the Work within the Contract Times due to delay beyond the control of Contractor, the Contract Times will be extended in an amount equal to the time lost due to such delay if a Claim is made therefor as provided in Paragraph 12.02.A. Delays beyond the control of Contractor shall include, but not be limited to, acts or neglect by Owner, acts or neglect of utility owners or other contractors performing other work as contemplated by Article 7, fires, floods, epidemics, abnormal weather conditions, or acts of God.
- B. If Owner, Engineer, or other contractors or utility owners performing other work for Owner as contemplated by Article 7, or anyone for whom Owner is responsible, delays, disrupts, or interferes with the performance or progress of the Work, then Contractor shall be entitled to an equitable adjustment in the Contract Price or the Contract Times, or both. Contractor's entitlement to an adjustment of the Contract Times is conditioned on such adjustment being essential to Contractor's ability to complete the Work within the Contract Times.
- C. If Contractor is delayed in the performance or progress of the Work by fire, flood, epidemic, abnormal weather conditions, acts of God, acts or failures to act of utility owners not under the control of Owner, or other causes not the fault of and beyond control of Owner and Contractor, then Contractor shall be entitled to an equitable adjustment in Contract Times, if such adjustment is essential to Contractor's ability to complete the Work within the Contract Times. Such an adjustment shall be Contractor's sole and exclusive remedy for the delays described in this Paragraph 12.03.C.
- D. Owner, Engineer, and their officers, directors, members, partners, employees, agents, consultants, or subcontractors shall not be liable to Contractor for any claims, costs, losses, or damages (including but not limited to all fees and charges of engineers, architects, attorneys, and other professionals and all court or arbitration or other dispute resolution costs) sustained by Contractor on or in connection with any other project or anticipated project.
- E. Contractor shall not be entitled to an adjustment in Contract Price or Contract Times for delays within the control of Contractor. Delays attributable to and within the control of a Subcontractor or Supplier shall be deemed to be delays within the control of Contractor.

ARTICLE 13 – TESTS AND INSPECTIONS; CORRECTION, REMOVAL OR ACCEPTANCE OF DEFECTIVE WORK

13.01 Notice of Defects

- A. Prompt notice of all defective Work of which Owner or Engineer has actual knowledge will be given to Contractor. Defective Work may be rejected, corrected, or accepted as provided in this Article 13.

13.02 Access to Work

- A. Owner, Engineer, their consultants and other representatives and personnel of Owner, independent testing laboratories, and governmental agencies with jurisdictional interests will have access to the Site and the Work at reasonable times for their observation, inspection, and testing. Contractor shall provide them proper and safe conditions for such access and advise them of Contractor's safety procedures and programs so that they may comply therewith as applicable.

13.03 Tests and Inspections

- A. Contractor shall give Engineer timely notice of readiness of the Work for all required inspections, tests, or approvals and shall cooperate with inspection and testing personnel to facilitate required inspections or tests.
- B. Owner shall employ and pay for the services of an independent testing laboratory to perform all inspections, tests, or approvals required by the Contract Documents except:
 - 1. for inspections, tests, or approvals covered by Paragraphs 13.03.C and 13.03.D below;
 - 2. that costs incurred in connection with tests or inspections conducted pursuant to Paragraph 13.04.B shall be paid as provided in Paragraph 13.04.C; and
 - 3. as otherwise specifically provided in the Contract Documents.
- C. If Laws or Regulations of any public body having jurisdiction require any Work (or part thereof) specifically to be inspected, tested, or approved by an employee or other representative of such public body, Contractor shall assume full responsibility for arranging and obtaining such inspections, tests, or approvals, pay all costs in connection therewith, and furnish Engineer the required certificates of inspection or approval.
- D. Contractor shall be responsible for arranging and obtaining and shall pay all costs in connection with any inspections, tests, or approvals required for Owner's and Engineer's acceptance of materials or equipment to be incorporated in the Work; or acceptance of materials, mix designs, or equipment submitted for approval prior to Contractor's purchase thereof for incorporation in the Work. Such inspections, tests, or approvals shall be performed by organizations acceptable to Owner and Engineer.

- E. If any Work (or the work of others) that is to be inspected, tested, or approved is covered by Contractor without written concurrence of Engineer, Contractor shall, if requested by Engineer, uncover such Work for observation.
- F. Uncovering Work as provided in Paragraph 13.03.E shall be at Contractor's expense unless Contractor has given Engineer timely notice of Contractor's intention to cover the same and Engineer has not acted with reasonable promptness in response to such notice.

13.04 *Uncovering Work*

- A. If any Work is covered contrary to the written request of Engineer, it must, if requested by Engineer, be uncovered for Engineer's observation and replaced at Contractor's expense.
- B. If Engineer considers it necessary or advisable that covered Work be observed by Engineer or inspected or tested by others, Contractor, at Engineer's request, shall uncover, expose, or otherwise make available for observation, inspection, or testing as Engineer may require, that portion of the Work in question, furnishing all necessary labor, material, and equipment.
- C. If it is found that the uncovered Work is defective, Contractor shall pay all claims, costs, losses, and damages (including but not limited to all fees and charges of engineers, architects, attorneys, and other professionals and all court or arbitration or other dispute resolution costs) arising out of or relating to such uncovering, exposure, observation, inspection, and testing, and of satisfactory replacement or reconstruction (including but not limited to all costs of repair or replacement of work of others); and Owner shall be entitled to an appropriate decrease in the Contract Price. If the parties are unable to agree as to the amount thereof, Owner may make a Claim therefor as provided in Paragraph 10.05.
- D. If the uncovered Work is not found to be defective, Contractor shall be allowed an increase in the Contract Price or an extension of the Contract Times, or both, directly attributable to such uncovering, exposure, observation, inspection, testing, replacement, and reconstruction. If the parties are unable to agree as to the amount or extent thereof, Contractor may make a Claim therefor as provided in Paragraph 10.05.

13.05 *Owner May Stop the Work*

- A. If the Work is defective, or Contractor fails to supply sufficient skilled workers or suitable materials or equipment, or fails to perform the Work in such a way that the completed Work will conform to the Contract Documents, Owner may order Contractor to stop the Work, or any portion thereof, until the cause for such order has been eliminated; however, this right of Owner to stop the Work shall not give rise to any duty on the part of Owner to exercise this right for the benefit of Contractor, any Subcontractor, any Supplier, any other individual or entity, or any surety for, or employee or agent of any of them.

13.06 *Correction or Removal of Defective Work*

- A. Promptly after receipt of written notice, Contractor shall correct all defective Work, whether or not fabricated, installed, or completed, or, if the Work has been rejected by Engineer, remove it from the Project and replace it with Work that is not defective. Contractor shall pay all claims, costs, losses, and damages (including but not limited to all fees and charges of engineers,

architects, attorneys, and other professionals and all court or arbitration or other dispute resolution costs) arising out of or relating to such correction or removal (including but not limited to all costs of repair or replacement of work of others).

- B. When correcting defective Work under the terms of this Paragraph 13.06 or Paragraph 13.07, Contractor shall take no action that would void or otherwise impair Owner's special warranty and guarantee, if any, on said Work.

13.07 *Correction Period*

- A. If within one year after the date of Substantial Completion (or such longer period of time as may be prescribed by the terms of any applicable special guarantee required by the Contract Documents) or by any specific provision of the Contract Documents, any Work is found to be defective, or if the repair of any damages to the land or areas made available for Contractor's use by Owner or permitted by Laws and Regulations as contemplated in Paragraph 6.11.A is found to be defective, Contractor shall promptly, without cost to Owner and in accordance with Owner's written instructions:
1. repair such defective land or areas; or
 2. correct such defective Work; or
 3. if the defective Work has been rejected by Owner, remove it from the Project and replace it with Work that is not defective, and
 4. satisfactorily correct or repair or remove and replace any damage to other Work, to the work of others or other land or areas resulting therefrom.
- B. If Contractor does not promptly comply with the terms of Owner's written instructions, or in an emergency where delay would cause serious risk of loss or damage, Owner may have the defective Work corrected or repaired or may have the rejected Work removed and replaced. All claims, costs, losses, and damages (including but not limited to all fees and charges of engineers, architects, attorneys, and other professionals and all court or arbitration or other dispute resolution costs) arising out of or relating to such correction or repair or such removal and replacement (including but not limited to all costs of repair or replacement of work of others) will be paid by Contractor.
- C. In special circumstances where a particular item of equipment is placed in continuous service before Substantial Completion of all the Work, the correction period for that item may start to run from an earlier date if so provided in the Specifications.
- D. Where defective Work (and damage to other Work resulting therefrom) has been corrected or removed and replaced under this Paragraph 13.07, the correction period hereunder with respect to such Work will be extended for an additional period of one year after such correction or removal and replacement has been satisfactorily completed.
- E. Contractor's obligations under this Paragraph 13.07 are in addition to any other obligation or warranty. The provisions of this Paragraph 13.07 shall not be construed as a substitute for, or a waiver of, the provisions of any applicable statute of limitation or repose.

13.08 *Acceptance of Defective Work*

- A. If, instead of requiring correction or removal and replacement of defective Work, Owner (and, prior to Engineer's recommendation of final payment, Engineer) prefers to accept it, Owner may do so. Contractor shall pay all claims, costs, losses, and damages (including but not limited to all fees and charges of engineers, architects, attorneys, and other professionals and all court or arbitration or other dispute resolution costs) attributable to Owner's evaluation of and determination to accept such defective Work (such costs to be approved by Engineer as to reasonableness) and for the diminished value of the Work to the extent not otherwise paid by Contractor pursuant to this sentence. If any such acceptance occurs prior to Engineer's recommendation of final payment, a Change Order will be issued incorporating the necessary revisions in the Contract Documents with respect to the Work, and Owner shall be entitled to an appropriate decrease in the Contract Price, reflecting the diminished value of Work so accepted. If the parties are unable to agree as to the amount thereof, Owner may make a Claim therefor as provided in Paragraph 10.05. If the acceptance occurs after such recommendation, an appropriate amount will be paid by Contractor to Owner.

13.09 *Owner May Correct Defective Work*

- A. If Contractor fails within a reasonable time after written notice from Engineer to correct defective Work, or to remove and replace rejected Work as required by Engineer in accordance with Paragraph 13.06.A, or if Contractor fails to perform the Work in accordance with the Contract Documents, or if Contractor fails to comply with any other provision of the Contract Documents, Owner may, after seven days written notice to Contractor, correct, or remedy any such deficiency.
- B. In exercising the rights and remedies under this Paragraph 13.09, Owner shall proceed expeditiously. In connection with such corrective or remedial action, Owner may exclude Contractor from all or part of the Site, take possession of all or part of the Work and suspend Contractor's services related thereto, take possession of Contractor's tools, appliances, construction equipment and machinery at the Site, and incorporate in the Work all materials and equipment stored at the Site or for which Owner has paid Contractor but which are stored elsewhere. Contractor shall allow Owner, Owner's representatives, agents and employees, Owner's other contractors, and Engineer and Engineer's consultants access to the Site to enable Owner to exercise the rights and remedies under this Paragraph.
- C. All claims, costs, losses, and damages (including but not limited to all fees and charges of engineers, architects, attorneys, and other professionals and all court or arbitration or other dispute resolution costs) incurred or sustained by Owner in exercising the rights and remedies under this Paragraph 13.09 will be charged against Contractor, and a Change Order will be issued incorporating the necessary revisions in the Contract Documents with respect to the Work; and Owner shall be entitled to an appropriate decrease in the Contract Price. If the parties are unable to agree as to the amount of the adjustment, Owner may make a Claim therefor as provided in Paragraph 10.05. Such claims, costs, losses and damages will include but not be limited to all costs of repair, or replacement of work of others destroyed or damaged by correction, removal, or replacement of Contractor's defective Work.

- D. Contractor shall not be allowed an extension of the Contract Times because of any delay in the performance of the Work attributable to the exercise by Owner of Owner's rights and remedies under this Paragraph 13.09.

ARTICLE 14 – PAYMENTS TO CONTRACTOR AND COMPLETION

14.01 Schedule of Values

- A. The Schedule of Values established as provided in Paragraph 2.07.A will serve as the basis for progress payments and will be incorporated into a form of Application for Payment acceptable to Engineer. Progress payments on account of Unit Price Work will be based on the number of units completed.

14.02 Progress Payments

A. Applications for Payments:

1. At least 20 days before the date established in the Agreement for each progress payment (but not more often than once a month), Contractor shall submit to Engineer for review an Application for Payment filled out and signed by Contractor covering the Work completed as of the date of the Application and accompanied by such supporting documentation as is required by the Contract Documents. If payment is requested on the basis of materials and equipment not incorporated in the Work but delivered and suitably stored at the Site or at another location agreed to in writing, the Application for Payment shall also be accompanied by a bill of sale, invoice, or other documentation warranting that Owner has received the materials and equipment free and clear of all Liens and evidence that the materials and equipment are covered by appropriate property insurance or other arrangements to protect Owner's interest therein, all of which must be satisfactory to Owner.
2. Beginning with the second Application for Payment, each Application shall include an affidavit of Contractor stating that all previous progress payments received on account of the Work have been applied on account to discharge Contractor's legitimate obligations associated with prior Applications for Payment.
3. The amount of retainage with respect to progress payments will be as stipulated in the Agreement.

B. Review of Applications:

1. Engineer will, within 10 days after receipt of each Application for Payment, either indicate in writing a recommendation of payment and present the Application to Owner or return the Application to Contractor indicating in writing Engineer's reasons for refusing to recommend payment. In the latter case, Contractor may make the necessary corrections and resubmit the Application.
2. Engineer's recommendation of any payment requested in an Application for Payment will constitute a representation by Engineer to Owner, based on Engineer's observations of the executed Work as an experienced and qualified design professional, and on Engineer's

review of the Application for Payment and the accompanying data and schedules, that to the best of Engineer's knowledge, information and belief:

- a. the Work has progressed to the point indicated;
 - b. the quality of the Work is generally in accordance with the Contract Documents (subject to an evaluation of the Work as a functioning whole prior to or upon Substantial Completion, the results of any subsequent tests called for in the Contract Documents, a final determination of quantities and classifications for Unit Price Work under Paragraph 9.07, and any other qualifications stated in the recommendation); and
 - c. the conditions precedent to Contractor's being entitled to such payment appear to have been fulfilled in so far as it is Engineer's responsibility to observe the Work.
3. By recommending any such payment Engineer will not thereby be deemed to have represented that:
- a. inspections made to check the quality or the quantity of the Work as it has been performed have been exhaustive, extended to every aspect of the Work in progress, or involved detailed inspections of the Work beyond the responsibilities specifically assigned to Engineer in the Contract Documents; or
 - b. there may not be other matters or issues between the parties that might entitle Contractor to be paid additionally by Owner or entitle Owner to withhold payment to Contractor.
4. Neither Engineer's review of Contractor's Work for the purposes of recommending payments nor Engineer's recommendation of any payment, including final payment, will impose responsibility on Engineer:
- a. to supervise, direct, or control the Work, or
 - b. for the means, methods, techniques, sequences, or procedures of construction, or the safety precautions and programs incident thereto, or
 - c. for Contractor's failure to comply with Laws and Regulations applicable to Contractor's performance of the Work, or
 - d. to make any examination to ascertain how or for what purposes Contractor has used the moneys paid on account of the Contract Price, or
 - e. to determine that title to any of the Work, materials, or equipment has passed to Owner free and clear of any Liens.
5. Engineer may refuse to recommend the whole or any part of any payment if, in Engineer's opinion, it would be incorrect to make the representations to Owner stated in Paragraph 14.02.B.2. Engineer may also refuse to recommend any such payment or, because of subsequently discovered evidence or the results of subsequent inspections or tests, revise or revoke any such payment recommendation previously made, to such extent as may be necessary in Engineer's opinion to protect Owner from loss because:

- a. the Work is defective, or completed Work has been damaged, requiring correction or replacement;
- b. the Contract Price has been reduced by Change Orders;
- c. Owner has been required to correct defective Work or complete Work in accordance with Paragraph 13.09; or
- d. Engineer has actual knowledge of the occurrence of any of the events enumerated in Paragraph 15.02.A.

C. *Payment Becomes Due:*

1. Ten days after presentation of the Application for Payment to Owner with Engineer's recommendation, the amount recommended will (subject to the provisions of Paragraph 14.02.D) become due, and when due will be paid by Owner to Contractor.

D. *Reduction in Payment:*

1. Owner may refuse to make payment of the full amount recommended by Engineer because:
 - a. claims have been made against Owner on account of Contractor's performance or furnishing of the Work;
 - b. Liens have been filed in connection with the Work, except where Contractor has delivered a specific bond satisfactory to Owner to secure the satisfaction and discharge of such Liens;
 - c. there are other items entitling Owner to a set-off against the amount recommended; or
 - d. Owner has actual knowledge of the occurrence of any of the events enumerated in Paragraphs 14.02.B.5.a through 14.02.B.5.c or Paragraph 15.02.A.
2. If Owner refuses to make payment of the full amount recommended by Engineer, Owner will give Contractor immediate written notice (with a copy to Engineer) stating the reasons for such action and promptly pay Contractor any amount remaining after deduction of the amount so withheld. Owner shall promptly pay Contractor the amount so withheld, or any adjustment thereto agreed to by Owner and Contractor, when Contractor remedies the reasons for such action.
3. Upon a subsequent determination that Owner's refusal of payment was not justified, the amount wrongfully withheld shall be treated as an amount due as determined by Paragraph 14.02.C.1 and subject to interest as provided in the Agreement.

14.03 *Contractor's Warranty of Title*

- A. Contractor warrants and guarantees that title to all Work, materials, and equipment covered by any Application for Payment, whether incorporated in the Project or not, will pass to Owner no later than the time of payment free and clear of all Liens.

14.04 *Substantial Completion*

- A. When Contractor considers the entire Work ready for its intended use Contractor shall notify Owner and Engineer in writing that the entire Work is substantially complete (except for items specifically listed by Contractor as incomplete) and request that Engineer issue a certificate of Substantial Completion.
- B. Promptly after Contractor's notification, Owner, Contractor, and Engineer shall make an inspection of the Work to determine the status of completion. If Engineer does not consider the Work substantially complete, Engineer will notify Contractor in writing giving the reasons therefor.
- C. If Engineer considers the Work substantially complete, Engineer will deliver to Owner a tentative certificate of Substantial Completion which shall fix the date of Substantial Completion. There shall be attached to the certificate a tentative list of items to be completed or corrected before final payment. Owner shall have seven days after receipt of the tentative certificate during which to make written objection to Engineer as to any provisions of the certificate or attached list. If, after considering such objections, Engineer concludes that the Work is not substantially complete, Engineer will, within 14 days after submission of the tentative certificate to Owner, notify Contractor in writing, stating the reasons therefor. If, after consideration of Owner's objections, Engineer considers the Work substantially complete, Engineer will, within said 14 days, execute and deliver to Owner and Contractor a definitive certificate of Substantial Completion (with a revised tentative list of items to be completed or corrected) reflecting such changes from the tentative certificate as Engineer believes justified after consideration of any objections from Owner.
- D. At the time of delivery of the tentative certificate of Substantial Completion, Engineer will deliver to Owner and Contractor a written recommendation as to division of responsibilities pending final payment between Owner and Contractor with respect to security, operation, safety, and protection of the Work, maintenance, heat, utilities, insurance, and warranties and guarantees. Unless Owner and Contractor agree otherwise in writing and so inform Engineer in writing prior to Engineer's issuing the definitive certificate of Substantial Completion, Engineer's aforesaid recommendation will be binding on Owner and Contractor until final payment.
- E. Owner shall have the right to exclude Contractor from the Site after the date of Substantial Completion subject to allowing Contractor reasonable access to remove its property and complete or correct items on the tentative list.

14.05 *Partial Utilization*

- A. Prior to Substantial Completion of all the Work, Owner may use or occupy any substantially completed part of the Work which has specifically been identified in the Contract Documents, or which Owner, Engineer, and Contractor agree constitutes a separately functioning and usable part of the Work that can be used by Owner for its intended purpose without significant interference with Contractor's performance of the remainder of the Work, subject to the following conditions:

1. Owner at any time may request Contractor in writing to permit Owner to use or occupy any such part of the Work which Owner believes to be ready for its intended use and substantially complete. If and when Contractor agrees that such part of the Work is substantially complete, Contractor, Owner, and Engineer will follow the procedures of Paragraph 14.04.A through D for that part of the Work.
2. Contractor at any time may notify Owner and Engineer in writing that Contractor considers any such part of the Work ready for its intended use and substantially complete and request Engineer to issue a certificate of Substantial Completion for that part of the Work.
3. Within a reasonable time after either such request, Owner, Contractor, and Engineer shall make an inspection of that part of the Work to determine its status of completion. If Engineer does not consider that part of the Work to be substantially complete, Engineer will notify Owner and Contractor in writing giving the reasons therefor. If Engineer considers that part of the Work to be substantially complete, the provisions of Paragraph 14.04 will apply with respect to certification of Substantial Completion of that part of the Work and the division of responsibility in respect thereof and access thereto.
4. No use or occupancy or separate operation of part of the Work may occur prior to compliance with the requirements of Paragraph 5.10 regarding property insurance.

14.06 *Final Inspection*

- A. Upon written notice from Contractor that the entire Work or an agreed portion thereof is complete, Engineer will promptly make a final inspection with Owner and Contractor and will notify Contractor in writing of all particulars in which this inspection reveals that the Work is incomplete or defective. Contractor shall immediately take such measures as are necessary to complete such Work or remedy such deficiencies.

14.07 *Final Payment*

A. *Application for Payment:*

1. After Contractor has, in the opinion of Engineer, satisfactorily completed all corrections identified during the final inspection and has delivered, in accordance with the Contract Documents, all maintenance and operating instructions, schedules, guarantees, bonds, certificates or other evidence of insurance, certificates of inspection, marked-up record documents (as provided in Paragraph 6.12), and other documents, Contractor may make application for final payment following the procedure for progress payments.
2. The final Application for Payment shall be accompanied (except as previously delivered) by:
 - a. all documentation called for in the Contract Documents, including but not limited to the evidence of insurance required by Paragraph 5.04.B.6;
 - b. consent of the surety, if any, to final payment;
 - c. a list of all Claims against Owner that Contractor believes are unsettled; and

- d. complete and legally effective releases or waivers (satisfactory to Owner) of all Lien rights arising out of or Liens filed in connection with the Work.
3. In lieu of the releases or waivers of Liens specified in Paragraph 14.07.A.2 and as approved by Owner, Contractor may furnish receipts or releases in full and an affidavit of Contractor that: (i) the releases and receipts include all labor, services, material, and equipment for which a Lien could be filed; and (ii) all payrolls, material and equipment bills, and other indebtedness connected with the Work for which Owner might in any way be responsible, or which might in any way result in liens or other burdens on Owner's property, have been paid or otherwise satisfied. If any Subcontractor or Supplier fails to furnish such a release or receipt in full, Contractor may furnish a bond or other collateral satisfactory to Owner to indemnify Owner against any Lien.

B. Engineer's Review of Application and Acceptance:

1. If, on the basis of Engineer's observation of the Work during construction and final inspection, and Engineer's review of the final Application for Payment and accompanying documentation as required by the Contract Documents, Engineer is satisfied that the Work has been completed and Contractor's other obligations under the Contract Documents have been fulfilled, Engineer will, within ten days after receipt of the final Application for Payment, indicate in writing Engineer's recommendation of payment and present the Application for Payment to Owner for payment. At the same time Engineer will also give written notice to Owner and Contractor that the Work is acceptable subject to the provisions of Paragraph 14.09. Otherwise, Engineer will return the Application for Payment to Contractor, indicating in writing the reasons for refusing to recommend final payment, in which case Contractor shall make the necessary corrections and resubmit the Application for Payment.

C. Payment Becomes Due:

1. Thirty days after the presentation to Owner of the Application for Payment and accompanying documentation, the amount recommended by Engineer, less any sum Owner is entitled to set off against Engineer's recommendation, including but not limited to liquidated damages, will become due and will be paid by Owner to Contractor.

14.08 Final Completion Delayed

- A. If, through no fault of Contractor, final completion of the Work is significantly delayed, and if Engineer so confirms, Owner shall, upon receipt of Contractor's final Application for Payment (for Work fully completed and accepted) and recommendation of Engineer, and without terminating the Contract, make payment of the balance due for that portion of the Work fully completed and accepted. If the remaining balance to be held by Owner for Work not fully completed or corrected is less than the retainage stipulated in the Agreement, and if bonds have been furnished as required in Paragraph 5.01, the written consent of the surety to the payment of the balance due for that portion of the Work fully completed and accepted shall be submitted by Contractor to Engineer with the Application for such payment. Such payment shall be made under the terms and conditions governing final payment, except that it shall not constitute a waiver of Claims.

14.09 *Waiver of Claims*

- A. The making and acceptance of final payment will constitute:
1. a waiver of all Claims by Owner against Contractor, except Claims arising from unsettled Liens, from defective Work appearing after final inspection pursuant to Paragraph 14.06, from failure to comply with the Contract Documents or the terms of any special guarantees specified therein, or from Contractor's continuing obligations under the Contract Documents; and
 2. a waiver of all Claims by Contractor against Owner other than those previously made in accordance with the requirements herein and expressly acknowledged by Owner in writing as still unsettled.

ARTICLE 15 – SUSPENSION OF WORK AND TERMINATION

15.01 *Owner May Suspend Work*

- A. At any time and without cause, Owner may suspend the Work or any portion thereof for a period of not more than 90 consecutive days by notice in writing to Contractor and Engineer which will fix the date on which Work will be resumed. Contractor shall resume the Work on the date so fixed. Contractor shall be granted an adjustment in the Contract Price or an extension of the Contract Times, or both, directly attributable to any such suspension if Contractor makes a Claim therefor as provided in Paragraph 10.05.

15.02 *Owner May Terminate for Cause*

- A. The occurrence of any one or more of the following events will justify termination for cause:
1. Contractor's persistent failure to perform the Work in accordance with the Contract Documents (including, but not limited to, failure to supply sufficient skilled workers or suitable materials or equipment or failure to adhere to the Progress Schedule established under Paragraph 2.07 as adjusted from time to time pursuant to Paragraph 6.04);
 2. Contractor's disregard of Laws or Regulations of any public body having jurisdiction;
 3. Contractor's repeated disregard of the authority of Engineer; or
 4. Contractor's violation in any substantial way of any provisions of the Contract Documents.
- B. If one or more of the events identified in Paragraph 15.02.A occur, Owner may, after giving Contractor (and surety) seven days written notice of its intent to terminate the services of Contractor:
1. exclude Contractor from the Site, and take possession of the Work and of all Contractor's tools, appliances, construction equipment, and machinery at the Site, and use the same to the full extent they could be used by Contractor (without liability to Contractor for trespass or conversion);

2. incorporate in the Work all materials and equipment stored at the Site or for which Owner has paid Contractor but which are stored elsewhere; and
 3. complete the Work as Owner may deem expedient.
- C. If Owner proceeds as provided in Paragraph 15.02.B, Contractor shall not be entitled to receive any further payment until the Work is completed. If the unpaid balance of the Contract Price exceeds all claims, costs, losses, and damages (including but not limited to all fees and charges of engineers, architects, attorneys, and other professionals and all court or arbitration or other dispute resolution costs) sustained by Owner arising out of or relating to completing the Work, such excess will be paid to Contractor. If such claims, costs, losses, and damages exceed such unpaid balance, Contractor shall pay the difference to Owner. Such claims, costs, losses, and damages incurred by Owner will be reviewed by Engineer as to their reasonableness and, when so approved by Engineer, incorporated in a Change Order. When exercising any rights or remedies under this Paragraph, Owner shall not be required to obtain the lowest price for the Work performed.
- D. Notwithstanding Paragraphs 15.02.B and 15.02.C, Contractor's services will not be terminated if Contractor begins within seven days of receipt of notice of intent to terminate to correct its failure to perform and proceeds diligently to cure such failure within no more than 30 days of receipt of said notice.
- E. Where Contractor's services have been so terminated by Owner, the termination will not affect any rights or remedies of Owner against Contractor then existing or which may thereafter accrue. Any retention or payment of moneys due Contractor by Owner will not release Contractor from liability.
- F. If and to the extent that Contractor has provided a performance bond under the provisions of Paragraph 5.01.A, the termination procedures of that bond shall supersede the provisions of Paragraphs 15.02.B and 15.02.C.

15.03 *Owner May Terminate For Convenience*

- A. Upon seven days written notice to Contractor and Engineer, Owner may, without cause and without prejudice to any other right or remedy of Owner, terminate the Contract. In such case, Contractor shall be paid for (without duplication of any items):
1. completed and acceptable Work executed in accordance with the Contract Documents prior to the effective date of termination, including fair and reasonable sums for overhead and profit on such Work;
 2. expenses sustained prior to the effective date of termination in performing services and furnishing labor, materials, or equipment as required by the Contract Documents in connection with uncompleted Work, plus fair and reasonable sums for overhead and profit on such expenses;
 3. all claims, costs, losses, and damages (including but not limited to all fees and charges of engineers, architects, attorneys, and other professionals and all court or arbitration or other

dispute resolution costs) incurred in settlement of terminated contracts with Subcontractors, Suppliers, and others; and

4. reasonable expenses directly attributable to termination.

B. Contractor shall not be paid on account of loss of anticipated profits or revenue or other economic loss arising out of or resulting from such termination.

15.04 *Contractor May Stop Work or Terminate*

A. If, through no act or fault of Contractor, (i) the Work is suspended for more than 90 consecutive days by Owner or under an order of court or other public authority, or (ii) Engineer fails to act on any Application for Payment within 30 days after it is submitted, or (iii) Owner fails for 30 days to pay Contractor any sum finally determined to be due, then Contractor may, upon seven days written notice to Owner and Engineer, and provided Owner or Engineer do not remedy such suspension or failure within that time, terminate the Contract and recover from Owner payment on the same terms as provided in Paragraph 15.03.

B. In lieu of terminating the Contract and without prejudice to any other right or remedy, if Engineer has failed to act on an Application for Payment within 30 days after it is submitted, or Owner has failed for 30 days to pay Contractor any sum finally determined to be due, Contractor may, seven days after written notice to Owner and Engineer, stop the Work until payment is made of all such amounts due Contractor, including interest thereon. The provisions of this Paragraph 15.04 are not intended to preclude Contractor from making a Claim under Paragraph 10.05 for an adjustment in Contract Price or Contract Times or otherwise for expenses or damage directly attributable to Contractor's stopping the Work as permitted by this Paragraph.

ARTICLE 16 – DISPUTE RESOLUTION

16.01 *Methods and Procedures*

A. Either Owner or Contractor may request mediation of any Claim submitted to Engineer for a decision under Paragraph 10.05 before such decision becomes final and binding. The mediation will be governed by the Construction Industry Mediation Rules of the American Arbitration Association in effect as of the Effective Date of the Agreement. The request for mediation shall be submitted in writing to the American Arbitration Association and the other party to the Contract. Timely submission of the request shall stay the effect of Paragraph 10.05.E.

B. Owner and Contractor shall participate in the mediation process in good faith. The process shall be concluded within 60 days of filing of the request. The date of termination of the mediation shall be determined by application of the mediation rules referenced above.

C. If the Claim is not resolved by mediation, Engineer's action under Paragraph 10.05.C or a denial pursuant to Paragraphs 10.05.C.3 or 10.05.D shall become final and binding 30 days after termination of the mediation unless, within that time period, Owner or Contractor:

1. elects in writing to invoke any dispute resolution process provided for in the Supplementary Conditions; or

2. agrees with the other party to submit the Claim to another dispute resolution process; or
3. gives written notice to the other party of the intent to submit the Claim to a court of competent jurisdiction.

ARTICLE 17 – MISCELLANEOUS

17.01 Giving Notice

- A. Whenever any provision of the Contract Documents requires the giving of written notice, it will be deemed to have been validly given if:
 1. delivered in person to the individual or to a member of the firm or to an officer of the corporation for whom it is intended; or
 2. delivered at or sent by registered or certified mail, postage prepaid, to the last business address known to the giver of the notice.

17.02 Computation of Times

- A. When any period of time is referred to in the Contract Documents by days, it will be computed to exclude the first and include the last day of such period. If the last day of any such period falls on a Saturday or Sunday or on a day made a legal holiday by the law of the applicable jurisdiction, such day will be omitted from the computation.

17.03 Cumulative Remedies

- A. The duties and obligations imposed by these General Conditions and the rights and remedies available hereunder to the parties hereto are in addition to, and are not to be construed in any way as a limitation of, any rights and remedies available to any or all of them which are otherwise imposed or available by Laws or Regulations, by special warranty or guarantee, or by other provisions of the Contract Documents. The provisions of this Paragraph will be as effective as if repeated specifically in the Contract Documents in connection with each particular duty, obligation, right, and remedy to which they apply.

17.04 Survival of Obligations

- A. All representations, indemnifications, warranties, and guarantees made in, required by, or given in accordance with the Contract Documents, as well as all continuing obligations indicated in the Contract Documents, will survive final payment, completion, and acceptance of the Work or termination or completion of the Contract or termination of the services of Contractor.

17.05 Controlling Law

- A. This Contract is to be governed by the law of the state in which the Project is located.

17.06 Headings

- A. Article and paragraph headings are inserted for convenience only and do not constitute parts of these General Conditions.

SECTION 4
SUPPLEMENTARY CONDITIONS

SUPPLEMENTARY CONDITIONS

These Supplementary Conditions amend or supplement the Standard General Conditions of the Construction Contract (EJCDC C-700, 2007 ed.) and other provisions of the Contract Documents as indicated below. All provisions which are not so amended or supplemented herein or in the Specific Project Requirements remain in full force and effect.

SC-1.01 The terms used in these Supplementary Conditions which are defined in the General Conditions have the meaning assigned to them in the General Conditions.

SC-2.02 Delete paragraph 2.02A in its entirety and insert the following in its place:

Owner shall furnish one (1) printed/hard copy of the drawings and Project Manual which shall be an executed contract set and one set in electronic format (.pdf), if requested.

SC-2.03 In the last sentence of 2.03A, change "sixtieth day" to "ninetieth day."

SC-4.02(A) Change "Supplementary Conditions" to read "Specific Project Requirements."

SC-5.03(A)(1) The required Certificate of Insurance shall be in a form satisfactory to the Owner (most current version of ACORD 25 or approved equal). If the Contractor fails to procure and maintain any specified and/or required insurance, the Owner shall have the right to procure and maintain the said insurance for and in the name of the Contractor and the Contractor shall pay the cost thereof and shall furnish all necessary information to make effective and maintain such insurance.

SC-5.04(B)(1) Change "Supplementary Conditions" to read "Specific Project Requirements."

SC-5.04(B)(2) The limits of liability for the insurance required by paragraph 5.04(A) of the General Conditions shall provide coverage for not less than the following amounts or greater where required by Laws and Regulations:

5.04(A)(1) and (2) Workers' Compensation, etc., under paragraphs 5.04(A)(1) and 5.04(A)(2) of the General Conditions:

- | | |
|--|-------------|
| (a) State | Statutory |
| (b) Applicable Federal (e.g., Longshoreman's): | Statutory |
| (c) Employer's Liability: | \$1,000,000 |

5.04(A)(3), (4) and (5). Contractor's Liability Insurance under paragraphs 5.04(A)(3) through 5.04(A)(5) of the General Conditions which shall also include completed operations and product liability coverage.

- (a) Bodily Injury and Property Damage, Combined Single Limit (CSL) (Except Products and Completed Operations) Property Damage liability insurance will provide Explosion, Collapse, and Underground coverage where applicable.

Each Occurrence	\$2,000,000*
General Aggregate	\$4,000,000*
(b) Products and Completed Operations Aggregate	\$1,000,000

Products and Completed Operations to be maintained for two (2) years after final payment and Contractor shall continue to provide evidence of such coverage to the Owner on an annual basis during the aforementioned period.

- (c) Personal and Advertising Injury (Per Person/Organization and per occurrence) with Employment Exclusion deleted. \$1,000,000
- (d) Fire Damage \$100,000
- (e) *Umbrella Excess Liability – As needed to increase primary policy to required limits.
- (f) If the General Liability Policy includes a General Aggregate, such policy shall be endorsed to have General Aggregate apply to this project only (Per Project Aggregate Limit).

5.04(A)(6) Automobile Liability - (Owned, Non-Owned, Hired)
Contractor may provide split limits or combined single limit.

(a) Split Limits:

Bodily Injury,	Each Person:	\$2,000,000
	Each Occurrence	\$2,000,000
Property Damage,	Each Occurrence	\$1,000,000

or

(b) Combined Single Limit

Bodily Injury and Property Damage,		
	Each Occurrence	\$2,000,000

- (c) Umbrella Excess Liability – as needed to increase Primary Policy to specified limits.

SC-5.04(B)(3) Add the following to the end of the paragraph: “to the extent available in the insurance industry with industry standard exclusions and as allowed under the laws and regulations in the State of Ohio;”

SC-5.04(B)(4) Add the following:

Written notice of cancellation for non-payment of premium shall be at least 10 days.

Add the following paragraphs:

SC-5.04(C) Unless otherwise stated in Specific Project Requirements, the Contractor shall purchase and provide an "Owner's and Contractor's Protective Policy" with the Owner listed as the insured for the following limits:

Each Occurrence	\$1,000,000
General Aggregate	\$2,000,000

SC-5.04(D) Unless otherwise stated in Specific Project Requirements the Contractor shall purchase and maintain during the Contract Time "All Risk Builders' Risk Insurance," and/or "Installation Floater Insurance," and/or "Boiler and Machinery Insurance," and any and all insurance requirements of section GC-5.06 of the General Conditions as applicable for the type of work to be performed upon the Project to the full insurable value thereof for the benefit of the Owner, the Contractor, Subcontractors and Suppliers as their interest may appear. This insurance shall cover the work until final acceptance and final payment by the Owner. This provision shall in no way release the Contractor or Contractor's Surety from obligations under the Contract Documents to fully complete the Project. The original policy(s) shall be filed with the Owner or his designated representative.

SC-5.05 *Owner's Liability Insurance*

See SC-5.04(C) above.

SC-5.06 *Property Insurance*

Unless otherwise stated in Specific Project Requirements the Contractor, not the Owner, shall purchase and maintain during the Contract Time all property insurance required in section GC-5.06 of the General Conditions and as outlined in SC-5.04(D) above.

SC-6.02(C) Add the following Paragraph:

The Contractor shall be responsible for the Owner and/or Engineer's additional inspection and administrative costs for work performed beyond regular working hours as defined in this Section.

SC-6.10(B) Add the following:

Should the Owner be exempt from Ohio State Sales and Use Taxes on materials and equipment to be incorporated in the Project, the Contractor may obtain a

waiver and said taxes shall not be included in the Contract Price.

1. Owner will furnish the required certificates of tax exemption to Contractor for use in the purchase of supplies and materials to be incorporated into the work
2. Owner's exemption to Contractor does not apply to construction tools, machinery, equipment, or other property by or leased by Contractor, or to supplies or materials not incorporated into the work.

The Contractor shall withhold and/or pay all consumer, use, property, employment, income and other taxes in accordance with the laws and regulations of the United States, State of Ohio and Owner which are applicable during the performance of the work.

SC 6.17 *Shop Drawings and Samples*

Add the following new paragraphs immediately after paragraph 6.17E:

- F. Contractor shall furnish required submittals with sufficient information and accuracy in order to obtain required approval of an item with no more than three (3) submittals. Engineer will record Engineer's time for reviewing subsequent materials of shop drawings, samples, or other items requiring approval and Contractor shall reimburse Owner for Engineer's charges for such time.
- G. In the event that Contractor requests a substitution for a previously approved item, Contractor shall reimburse Owner for Engineer's charges for such time unless the need for such substitution is beyond the control of the Contractor.

SC-7.02 Delete Section 7.02 of the General Conditions in its entirety and insert the following:

SC-7.02(A) The General Construction Contractor shall be referred to and defined as the Construction Coordinator.

SC-7.02(B) Duties of the Construction Coordinator include the following:

1. Scheduling and coordinating the work of the Prime Contractors including submission and periodic updating of project schedule.
2. Establishing and administrating the site safety program and procedures for the project.
3. See that permits are applied for and obtained on a timely basis. Advise the Engineer of any problems related to permit approval.
4. Monitoring compliance with Laws and Regulations.
5. Maintain project site for dust, sedimentation, debris, waste, and general site cleanliness.

6. Coordinate location and use of temporary construction facilities including but not limited to sanitary, water, power, telephone, and parking.
7. Coordinate Owner interface for utility tie-ins/shut downs.
8. Monitor shop drawing submittal and coordination of submittal information between Prime Contractors.

SC-11.01(A) For purposes of "Cost of the Work" delete Section 11.01(A), (B), and (C) of the General Conditions in their entirety and insert ODOT 109.05, current edition in its place.

SC-13.07 (A) In the First sentence of Section 13.07(A) remove "Substantial Completion" and insert "Final Acceptance of the entire project and final payment by the Owner."

SC-13.07(C) Remove 13.07(C) and replace with the following:

All materials and equipment shall be warranted by the respective material supplier or equipment manufacturer until the end of the Contractor's "correction period" (or longer if specified elsewhere in the contract) regardless of date of initial installation or operation of the material or equipment. The cost of such extended warranties as needed from material suppliers or equipment manufacturers to provide warranty coverage until the end of the "correction period" or other period as specified in the contract shall be the responsibility of the prime contractor and shall be assumed to have been included in his bid.

SC-14.02 (A) (3) Delete Section 14.02(A) (3) of the General Conditions in its entirety and insert the following:

Until the job is 50% complete, the Contractor will be paid 92% of the estimated value of labor and material completed in acceptable form. After the work is 50% complete, no further funds shall be retained and the Contractor shall be paid 100% of the estimated value of labor and material completed in acceptable form, provided that the Contractor is making satisfactory progress and there is no specific cause for greater withholding. Upon the Owner's agreement that the project is substantially complete, the Retainage may be reduced to twice the value of the remaining punch list work subject to the recommendation of the Engineer and the approval by the Owner.

SC-14.02(A) (4) Add the following paragraph:

Payment for stored materials at invoice prices or at the unit price bid for materials, or the lesser value of the two, will be made for accepted nonperishable equipment and materials which are to be incorporated into the work, when accepted, delivered, properly stored, and protected upon the site and verified to the Engineer by a copy of the invoice. For materials and equipment meeting the foregoing conditions, the Owner will pay, when properly included in an approved estimate,

92% of the invoice value of the same. Subsequent to the inclusion of a payment for delivered materials in a progress payment, Contractor shall submit no later than the next payment submission, a partial waiver of lien from each and every supplier for whom delivered materials were paid. If no such waiver is submitted prior to or along with the next payment, the amount of delivered materials paid commensurate with that particular item will be deducted from future payments. No payment for delivered materials shall be made for any items that are scheduled to be incorporated in the work within 30 days of submission of the pay estimate. Delivered materials will not be paid in any given month for a total amount less than \$5,000.00. Payment for delivered materials for such items as pipe backfill and roadway subbase will not be routinely considered.

SC-16.01 Delete Article 16 in its entirety and replace with the following:

2/11

ARTICLE 16 - DISPUTE RESOLUTION AGREEMENT - MEDIATION/ARBITRATION

OWNER and CONTRACTOR hereby agree that Article 16 of the General Conditions to the Agreement between OWNER and CONTRACTOR is amended to include the following agreement of the parties:

- 16.01 All claims, disputes, and other matters in question between OWNER and CONTRACTOR arising out of or relating to the Contract Documents or the breach thereof (except for claims which have been waived by the making or acceptance of final payment as provided by paragraph 14.09) will be decided by arbitration in accordance with the Construction Industry Arbitration Rules of the American Arbitration Association then obtaining, subject to the limitations of this Article 16. This agreement so to arbitrate and any other agreement or consent to arbitrate entered into in accordance herewith as provided in this Article 16 will be specifically enforceable under the prevailing law of any court having jurisdiction.
- 16.02 No demand for arbitration of any claim, dispute, or other matter that is required to be referred to Engineer initially for decision in accordance with paragraph 9.09 will be made until the earlier of (a) the date on which ENGINEER has rendered a written decision or (b) the thirty-first day after the parties have presented their evidence to ENGINEER if a written decision has not been rendered by ENGINEER before that date. No demand for arbitration of any such claim, dispute or other matter will be made later than thirty days after the date on which ENGINEER has rendered a written decision in respect thereof in accordance with paragraph 9.08 and the failure to demand arbitration within said thirty days' period will result in Engineer's decision being final and binding upon OWNER and CONTRACTOR. If ENGINEER renders a decision after arbitration proceedings have been initiated, such decision may be entered as evidence but will not supersede the arbitration proceedings, except where the decision is acceptable to the parties concerned. No demand for arbitration of any written decision of ENGINEER rendered in accordance with paragraph 9.08 will be made later than ten days after the part making such demand has delivered written notice of intention to appeal as provided in paragraph 10.05.
- 16.03 Notice of the demand for arbitration will be filed in writing with the other party to the Agreement and with the American Arbitration Association, and a copy will be sent to ENGINEER for information. The demand for arbitration will be made within the thirty-day or ten-day period specified in paragraph 16.02 as applicable, and in all other cases within a reasonable time after the claim, dispute or other matter in question has arisen, and in no event shall any such demand be made after the date when institution of legal or equitable proceedings based on such claim, dispute or other matter in question would be barred by the applicable statute of limitations.
- 16.04 Except as provided in paragraph 16.05 below, no arbitration arising out of or relating to the Contract Documents shall include by consolidation, joiner or in any other manner any other person or entity (including ENGINEER, ENGINEER's Consultant, and the officers, directors, agents, employees, or consultants of any of them) who is not a party to this contract unless:

- (A) the inclusion of such other person or entity is necessary if complete relief is to be afforded among those who are already parties to the arbitration, and
- (B) such other person or entity is substantially involved in a question of law or fact which is common to those who are already parties to the arbitration and which will arise in such proceedings, and
- (C) the written consent of the other person or entity sought to be included and of OWNER and CONTRACTOR has been obtained for such inclusion, which consent shall make specific references to this paragraph; but no such consent shall constitute consent to arbitration of any dispute not specifically described in such consent or to arbitration with any party not specifically identified in such consent.

16.05 Notwithstanding paragraph 16.04 if a claim, dispute or other matter in question between OWNER and CONTRACTOR involves the Work of a Subcontractor, either OWNER or CONTRACTOR may join such Subcontractor as a party to the arbitration between OWNER and CONTRACTOR herein under. CONTRACTOR shall include in all subcontracts required by paragraph 6.06(G) a specific provision whereby the Subcontractor consents to being joined in an arbitration between OWNER and CONTRACTOR involving the Work and such Subcontractor. Nothing in this paragraph 16.05 nor in the provision of such subcontract consenting to joinder shall create any claim, right or cause of action in favor of Subcontractor and against OWNER, ENGINEER, or ENGINEER's Consultants that does not otherwise exist.

16.06 The award rendered by the arbitration will be final, judgment may be entered upon it in any court having jurisdiction thereof, and it will not be subject to modification or appeal.

16.07 OWNER and CONTRACTOR agree that they shall first submit any and all unsettled claim, counterclaims, disputes and other matters in questions between them arising out of or relating to the Contract Documents or the breach thereof ("disputes"), to mediation by the American Arbitration Association under the Construction Industry Mediation Rules of the American Arbitration Association prior to either of them initiating against the other a demand for arbitration pursuant to paragraphs 16.01 through 16.06, unless delay in initiating arbitration would irrevocably prejudice one of the parties. The respective thirty and ten day time limits within which to file a demand for arbitration as provided in paragraphs 16.02 and 16.03 above shall be suspended with respect to a dispute submitted to mediation within those same applicable time limits and shall remain suspended until ten days after the termination of the mediation. The mediator of any dispute submitted to mediation under this Agreement shall not serve as arbitrator of such dispute unless otherwise agreed.

ARTICLE 16 - DISPUTE RESOLUTION AGREEMENT - JUDICIAL SYSTEM

OWNER and CONTRACTOR hereby agree that Article 16 of the General Conditions to the Agreement between OWNER and CONTRACTOR is amended to include the following agreement of the parties:

- 16.01 All claims, disputes and other matters in question between Owner and Contractor arising out of or relating to the Contract Documents or the breach thereof (except for claims which have been waived by the making or acceptance of final payment as provided by Paragraph 14.09) will be decided through the _____ County Court of Common Pleas. Arbitration will be entered into only if agreed upon in writing by both parties.

SECTION 5
SPECIFICATIONS

MENTOR MUNICIPAL MAINTENANCE HVAC REPLACEMENT

VEHICLE MAINTENANCE AND STORAGE BUILDING

302.0 USE GROUP CLASSIFICATION
OFFICE AREAS - USE GROUP B
VEHICLE MAINTENANCE & STORAGE AREAS - USE GROUP S
304.0 BUSINESS USE GROUP
311.0 STORAGE USE GROUPS - S-1, MODERATE HAZARD STORAGE
313.0 MIXED USE GROUPS - NON-SERRATED USE GROUPS PER 313.1.1
503.0 HEIGHT & AREA LIMITATIONS - UNLIMITED AREA PER 507.0
AUTOMATIC SPRINKLER SYSTEM THROUGHOUT PER 906.2.1
AND ISOLATION PER 507.2

ACTUAL HEIGHT: 28'-6"

ACTUAL AREAS:
OFFICE BUILDING: 5,650 S.F.
VEHICLE STORAGE: 37,876 S.F.
VEHICLE MAINTENANCE: 18,000 S.F.
TOTAL FACILITY: 61,525 S.F.

507.2 EXTERIOR WALLS FIRE RESISTANCE RATING = 0HR
FIRE SEPARATION RESISTANCE 80 FEET OR GREATER
602.0 CONSTRUCTION CLASSIFICATION - 2C UNPROTECTED
FIRE RESISTANCE RATING OF STRUCTURAL ELEMENTS
1. EXTERIOR WALLS: LOAD BEARING = 0HR, NON LOAD BEARING = 0HR
2. FIRE WALLS/PARTY WALLS = 2HR
3. FIRE SEPARATION ASSEMBLIES: EXITS = 0HR, SHAFTS = 2HR
4. FIRE PARTITIONS: EXIT ACCESS CORRIDORS = 0HR
5. DWELLING UNIT SEPARATIONS = NONE
6. SMOKE BARRIERS = 1HR
7. NON-LOAD BEARING PARTITIONS = 0HR
8. INTERIOR LOADBEARING WALLS AND FRAMING = 0HR (ONE FLOOR OR ROOF)
9. STRUCTURAL MEMBERS SUPPORTING WALL = 0HR
10. FLOOR CONSTRUCTION INCLUDING BEAMS = 0HR
11. ROOF CONSTRUCTION = 0HR

904.0 FIRE SUPPRESSION SYSTEMS
AUTOMATIC FIRE SUPPRESSION SYSTEM PER 904.7
1006.5 LENGTHS OF EXIT ACCESS TRAVEL - 250FT (WITH SPRINKLER SYSTEM)
1008.0 OCCUPANT LOAD - SQ. FT. FLOOR AREA PER OCCUPANT
BUSINESS AREAS

100 GROSS S.F./PERSON = 57 OCCUPANTS

STORAGE AREAS, MECH. EQUIPMENT AREAS
300 GROSS S.F./PERSON = 196 OCCUPANTS

TOTAL OCCUPANT LOAD = 243 OCCUPANTS

DRAWING INDEX

CS	COVER SHEET
M001	MECHANICAL SPECIFICAIONS
M002	BUILDING AUTOMATION SYSTEM
M101	MECHANICAL PLAN
M601	LEGEND, EQUIPMENT SCHEDULES + NOTES

MENTOR MAINTENANCE CENTER

6645 HOPKINS ROAD
MENTOR, OHIO 44060

HVAC Conformance Requirements:

1. THE HVAC CONTRACTOR SHALL BE THE LEAD CONTRACTOR ON THE PROJECT.
2. THE CONTRACTORS SHALL READ THE SPECIFICATIONS AND REVIEW THE DRAWINGS. THE CONTRACTORS WILL BE REQUIRED TO CONFORM TO ALL REQUIREMENTS IN THE DOCUMENTS.
3. CONTRACTORS ARE REQUIRED TO PATCH AND REPAIR ANY EXISTING ADJACENT SERVICES WHICH ARE DAMAGED DURING THE COURSE OF DEMOLITION/CONSTRUCTION. ALL PATCHES AND REPAIRS SHALL MATCH PRIOR EXISTING CONDITIONS.
4. THE CONTRACTORS SHALL SECURE AND PAY FOR ALL PERMITS REQUIRED AND PROVIDE ALL CERTIFICATES OF INSPECTION.
5. REMOVAL OF ALL CONSTRUCTION DEBRIS IS THE RESPONSIBILITY OF THE RESPECTIVE CONTRACTOR. IF DUMPSTERS ARE REQUIRED, SET IN LOCATION SELECTED BY THE OWNER. ALL CONTAINERS SHALL BE COVERED AT THE END OF EACH WORKING DAY. REMOVAL OF DEBRIS SHALL NOT DISRUPT NORMAL BUILDING AND SITE FUNCTIONS.
6. CONTRACTOR SHALL FIELD VERIFY ALL CONDITIONS AT THE SITE. WHEN INDICATED CONDITIONS ON THE DRAWINGS CONFLICT WITH THE EXISTING CONDITIONS, CONTACT THE ENGINEER FOR CLARIFICATION.
7. CONTRACTORS SHALL PARK VEHICLES ON SITE WHERE INDICATED BY OWNER.

denk **DENK ASSOCIATES, INC.**
CONSULTING ENGINEERS
503 EAST 200TH STREET
CLEVELAND OHIO 44119-5144
PH: 216-531-8880
FAX: 216-531-5144

DATE: APRIL 04, 2026

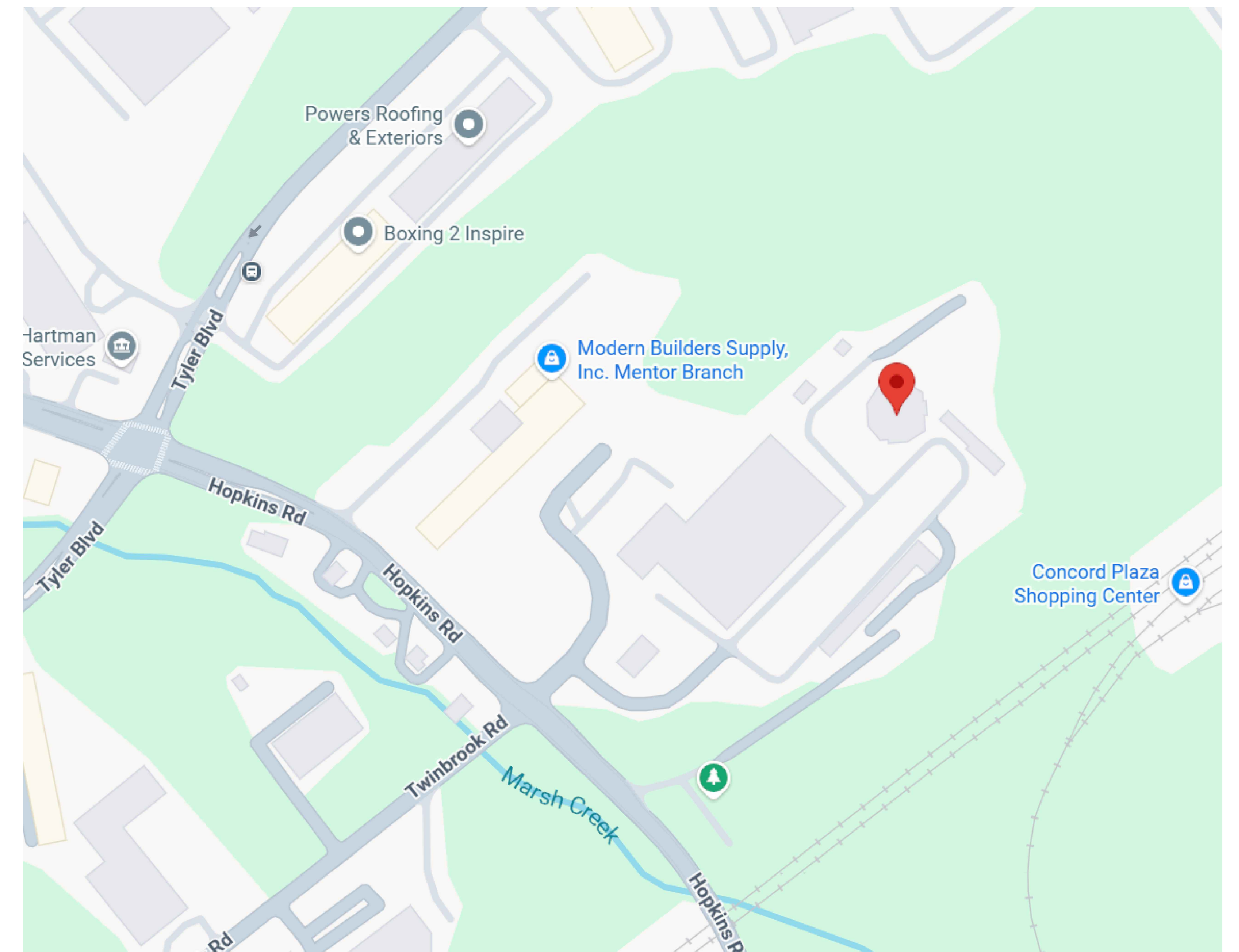

MECHANICAL SPECIFICATIONS

SECTION 15010

MECHANICAL GENERAL PROVISIONS

PART 1 GENERAL

- 1.01 GENERAL
A. The provisions of the Instructions to Bidders, General Conditions, Supplementary Conditions, Alternates, Addenda and Division 1 are a part of this Specification. A requirement appearing in one is as binding as though occurring in all. They are intended to be complementary and to describe and provide for a complete work. Contractors and Sub-contractors shall examine same as well as other Divisions of the Specifications which affect work under this Division.
B. Mechanical, Architectural, Structural, Electrical and all other Drawings as well as the Specifications for all the Divisions are a part of the Contract Documents.
C. Drawings and Specifications are to be considered as supplementing each other. Work specified but not indicated or indicated but not specified, shall be provided as though mentioned in both Specifications and Drawings.

1.02 WORK INCLUDES

- A. Mechanical General Provisions includes Plumbing, Heating, Ventilating, Air Conditioning, Fire Protection, Temperature Control, and Mechanical Systems Balancing, collectively, individually or in any combination of the several headings and the coordination and administration thereof.
B. Codes, Permits and Fees
1. Comply with rules, regulations of State, County, and City Authorities having jurisdiction over the premises, including safety requirements of OSHA. Do not construe this as relieving Contractor from complying with specifications, which exceed Code requirements, and not in conflict therewith.
2. Secure and pay for all permits and certificates of inspection required.
3. Deliver official record of approval by governing agencies to architect for transmittal to Owner.
4. Obtain all inspections required by law, ordinances, rules, regulations of authorities having jurisdiction. Furnish certificates of such inspections. Provide all equipment, power and labor necessary for inspections and tests.

1.03 SCOPE OF WORK

- A. The Bidder is required to examine carefully the site of the proposed work, the proposal, drawings, specifications, and contract forms. He shall satisfy himself as to the character, quality, and quantities of work to be performed, materials to be provided, and as to the requirements of these specifications, special provisions and contract. The submission of a proposal shall be prima facie evidence that the Bidder has made such an examination.
B. The Contractor shall, at his own expense, furnish all the necessary materials, labor, superintendence, tools, appliances, and equipment, and shall execute in a workmanlike manner the work of this contract within the time and in the manner specified, and in conformity with the requirements set forth in the specifications herein contained or hereto attached and in accordance with the contract drawings of said work.

1.04 SHOP DRAWINGS

- A. Prepare shop drawings for mechanical equipment with adequate details and scales as necessary to clearly show construction. Clearly identify each item on the drawings as to mark location and use.

1.05 COORDINATION AND SUPERVISION

- A. Examine work of other trades, which comes in contact with or is covered by this work. Do not attach to, cover, or finish against any defective work, or install work of this Division in a manner, which will prevent other trades from properly installing their work. Consult all drawings, specifications and details of other Divisions of the work.
B. If any work is installed so that the architectural design cannot be adhered to, Contractor is liable for cost of making such changes as Architect may require.
C. Provide adequate competent supervision at all times when work is being performed. Cooperate with all other trades to avoid interferences and delays.

1.06 LOCAL CONDITIONS

- A. Visit site, become familiar with conditions affecting this work. No additional payment will be made on claims that arise from lack of knowledge of existing conditions.
B. This project involves remodeling of existing areas in an operating facility. Plan work including alterations, connections to existing facilities, to permit carrying on normal building functions. When necessary to temporarily interrupt a service, arrange with Owner in advance as to time, which will be least disruptive. Consider all work as being performed during normal working hours and in conformity with approved work progress schedule.
C. Provide temporary services of any nature required to keep building functioning. Remove temporary services when permanent facilities are completed.
1.07 PRODUCT HANDLING
A. Pay all costs for transportation of materials, equipment to job site.
B. Provide all scaffolding, tackle, hoists, rigging necessary for placing mechanical materials and equipment in their proper place. Scaffolding, hoisting equipment, comply with applicable Federal, State, and Local regulations. Remove temporary work when no longer required.
C. Arrange for packaging of equipment, which must be hoisted, so that there will be no damage or distortion caused by hoisting operation. Protect all coils, bearings, fan shafts and housing from any damage during hoisting operation.
D. Store all heating, ventilating, air conditioning equipment, plumbing fixtures, etc., in dry location until building is ready to receive them. Protect all openings, bearings, motor controls, etc., from dirt and moisture.

PART 2 PRODUCTS

2.01 GUARANTEE AND WARRANTIES

- A. Warrant that equipment and all work is installed in accordance with good engineering practice and that all equipment will meet requirements specified. Any equipment failing to perform or function as specified shall be replaced with complying equipment, without cost to the Owner.
B. Guarantee against defects in workmanship and materials; make good, repair or replace any defective work, material or equipment within one year from date of acceptance.

2.02 EQUIPMENT

- A. Bids shall be based upon the specified product or listed alternative. Bidders may quote on substitute products by listing them on the substitution page of the bid form and by indicating the additional cost or credit. No later substitutions will be permitted. Refer to Instructions to Bidders.
B. Design drawings are based on the products specified by type model and size and thus establish minimum qualities, which substitutes must meet to qualify as acceptable. Proof of equality rests with the Bidder; provide all data necessary to demonstrate acceptability. The Architect reserves the right to reject proposed substitutes.
C. The bid price for each listed alternative or substitute shall include all costs required to incorporate the item into the project.
D. Where only one make is named, it shall be provided.

2.03 MATERIALS

- A. All materials shall be new, full weight, of the best quality with the same brand or manufacturer used for each class of material or equipment.

2.04 DAMAGE AND EMERGENCY REPAIRS

- A. Assume responsibility for any damage caused by leaks in the piping systems being installed under this Contract. Repair all damage without extra cost to Owner.

PART 3 EXECUTION

3.01 INSTALLATION REQUIREMENTS

- A. Locations of piping, equipment, ducts, etc., on the drawings are diagrammatic; indicated positions shall be followed as closely as possible; exact locations shall be subject to building construction and interferences with other work. Difficulties preventing the installation of any part of work as indicated shall be called to the attention of the Architect. Architect will determine locations and changes. Contractor shall install the work accordingly. Architect reserves right to make minor changes in location of any part of the work up to the time of roughing in without additional cost.
B. Do all cutting and patching in construction as necessary for installation of this work. Do not cut any structural member without specific permission from the Architect. Have cutting done by skilled mechanics as carefully as possible, and with as little damage as possible. Have patching done by first class mechanics, skilled in the several trades.
C. Take all measurements and determine all elevations at the building.

3.02 RECORD DRAWINGS

- A. Each Contractor or Sub-contractor for mechanical work shall keep one complete set of the contract working drawings on the job site on which he shall record any deviations or changes from such contract drawings made during construction.

3.04 EQUIPMENT IDENTIFICATION

- A. Identify each ROOFTOP UNIT as to nature of service and system number corresponding to designation on the drawings, by stenciling with 1" high letters or attaching two-color engraved plastic nameplates. Apply one coat lacquer or varnish over the stencils.

3.06 LUBRICATION, PACKING AND SUPPLIES

- A. Properly lubricate all equipment before it is started.
B. Install initial charge of refrigerant and any other supplies required to place equipment in operation.

3.07 TESTS AND ADJUSTMENTS

- A. All piping shall be given the following pressure test without appreciable pressure drop. Equipment which would be damaged by the required test pressure shall be isolated from the system during test.

Table with columns: SERVICE, MEDIUM, (PSI), HRS. Rows: Gas, Air, 50, 24

3.08 CLEANING UP

- A. At all times, keep premises and building in neat and orderly condition. Follow explicitly any instructions of Architect in regard to storing of materials, protective measures and disposing of debris.
B. Domestic water systems: Flush out system first, then hold a solution mixture of 500 ppm of chlorine in the water in system for a 24-hour period. Drain systems and flush. After flushing, chlorine residual shall not be in excess of 0.5 ppm at 4 widely spaced checkpoints. Chlorination procedures shall conform to AWWA Specification C601-54 and be accepted by local health department. Repeat chlorination if necessary until accepted.
C. Replace all throw away filters used during construction with proper system filters at completion of work.
E. After initial period of operation, clean all strainers, traps, and dirt legs.
F. Upon completion of work, remove all tools, equipment, surplus materials, thoroughly clean all piping, fixtures and equipment removing all dirt, grease and oil.

3.09 HVAC SYSTEMS ADJUSTMENTS AND BALANCE

- A. Put all heating, ventilating, exhaust and air conditioning systems and equipment into full operation and continue operation of same during each working day of testing and balancing. All testing and balancing shall be done under both cooling and heating modes of operation.
1. Balance and adjust air-handling system for design flow of supply, return and outdoor air to within 10% of design requirements.
2. Balance all diffusers, grilles, registers and VAV terminals to within 10% of design requirements. Submit recorded results of all testing to Architect in triplicate with room numbers, design air quantities and actual air quantities.
3. Submit tabulated results in triplicate including motor amperage, cfm, and location.

END OF SECTION

SECTION 15050

BASIC MATERIALS AND METHODS

PART 1 GENERAL

1.01 MATERIALS

- A. Pipe and Fittings
Gas (Inside Building) - Schedule 40 black steel, 150 lb. malleable iron fittings.
B. Valves
1. Valves shall be of the same manufacture where possible and equivalent to those manufactured by Nibco, Jenkins, Fairbanks, Powell, Milwaukee, Keystone or Hammond and withstand minimum 125 lbs. steam working pressure.
C. General Piping
2. Provide shutoff valves at all branch connections to main, at all fixture groupings, each piece of apparatus and in mains to sectionalize the systems.
3. Install valves with stems at or above horizontal position.
4. Plug open ends of pipe or equipment at all times during installation to keep dirt and foreign material out of system.
5. Arrange and install all pipes, valves, cleanouts, access openings and equipment so as to be accessible for service. Locate equipment to maintain clearances for tube, coil pulling, periodic servicing.

END OF SECTION

SECTION 15400

PLUMBING

PART 1 GENERAL

1.01 INSTALLATION

- B. Piping Systems
1. Provide gas as indicated on drawings with same being supplied and connected to all fixtures and equipment.
H. General Requirements for Plumbing
3. The Plumbing Contractor shall provide all plumbing fixtures indicated complete and ready for use.
4. All fixture supports to be of type permitting adjustment to fit variation in construction.
5. The Plumbing Contractor shall provide all stops, traps, escutcheons connections as necessary to complete installation of each fixture, whether such items are listed or not.
6. After all fixtures have been set and are ready for use, thoroughly clean all fixtures furnished, removing all stickers, rust stains and any other matter or discoloration leaving every part in good condition. Adjust all flush valves and other fixture water supplies to give proper water flow.
7. All finished exposed faucets, traps, connecting piping, stops, flush valves and other fixture trim shall be chromium-plated brass unless otherwise specified and shall be supported rigidly to fixtures and to walls with matching brackets. All fastenings shall be chromium-plated brass.
8. Assemble lavatory and sink wastes and traps with slip joints and compression fittings on fixture side of trap. Sewer side connections shall be made with screwed joints. Slip joints on sewer side of traps are not acceptable.
9. Vacuum breakers shall be provided as part of the fixture trim wherever there is a possibility of back siphoning.

END OF SECTION

SECTION 15800

AIR DISTRIBUTION

PART 1 GENERAL

1.01 WORK INCLUDES

- A. All HVAC materials, equipment and controls.
1.02 INSTALLATION
A. Provide all sheet metal work as indicated on the drawings in accordance with the latest edition of the ASHRAE guide and data book, SMACNA standards, 1995 Second Edition, and this specification, the most demanding of which shall be the minimum standard. All joints to be Seal Class "A".

PART 2 PRODUCTS

2.01 MATERIALS

- A. Low Pressure Ductwork
1. All ductwork shall be constructed of galvanized steel except where noted on plans to be aluminum. Exposed ductwork in architecturally finished spaces shall be fabricated from "Paint Grip" galvanized steel or similar mill surface etch treatment.
2. Construct all ductwork following SMACNA "HVAC Duct Construction Standards," 1995 edition.
3. Seal all ducts to seal Class "A."
B. All ductwork shall be constructed of galvanized steel except where noted on drawings to be aluminum. Exposed ductwork in architecturally finished spaces shall be fabricated from "Paint Grip" galvanized steel or similar mill surface etch treatment.
C. Dampers and Deflectors
1. Provide and install all manual dampers and deflectors indicated on drawings or where necessary to properly distribute and balance air. Provide damper in each supply duct leaving duct main and in each branch serving individual supply, return and exhaust outlets and where otherwise indicated.
E. Registers, Diffusers
1. In general, Taus is specified. Equals by Krueger, Carnes or Nalor Hart are acceptable.
2. All registers, diffusers to have a factory applied off white finish unless otherwise noted.
3. See drawings for schedule.
H. Roof Curbs and Equipment Supports
6. Where curbs and supports are not specified with HVAC equipment provide prefabricated roof curbs, equipment supports, pipe curb assembly for HVAC roof penetrations and equipment mounting.
M. Filters
9. Provide two (2) complete sets of filters for each filter bank. Install one set of filters in units when construction is complete. Furnish the other set as a spare to the Owner when the project is complete. Filters shall not be shipped to the jobsite until construction is complete and the units are ready to have the first set of clean filters installed.
N. Equipment
1. See drawings for schedule of HVAC equipment.

END OF SECTION

HVAC GENERAL NOTES:

- 1. ALL MECHANICAL EQUIPMENT AND INSTALLATIONS SHALL CONFORM WITH THE REQUIREMENTS OF THE IMC MECHANICAL CODE, THE IMC PLUMBING CODE, THE IMC BUILDING CODE, THE STATE ENERGY CODE, NFPA 90A, 101, AND ALL APPLICABLE CODES AND ORDINANCES.
2. CONTRACTOR SHALL COORDINATE ELECTRICAL CHARACTERISTICS AND REQUIREMENTS OF ALL MECHANICAL EQUIPMENT WITH ELECTRICAL DRAWINGS PRIOR TO ORDERING EQUIPMENT OR SUBMITTING SHOP DRAWINGS, AND SHALL FURNISH EQUIPMENT WIRED FOR THE VOLTAGES SHOWN THEREIN.
3. ALL MECHANICAL EQUIPMENT REQUIRING ELECTRICAL POWER SHALL BE INSTALLED WITH DISCONNECT SWITCHES AT EACH PIECE OF EQUIPMENT. COORDINATE SWITCH TYPE (FUSED OR NON-FUSED) WITH EQUIPMENT CHARACTERISTICS, MANUFACTURER'S RECOMMENDATIONS AND ELECTRICAL DRAWINGS. MECHANICAL CONTRACTOR SHALL PURCHASE ALL DISCONNECTS.
4. ALL REQUIRED CONTROL WIRING NOT SHOWN ON THE ELECTRICAL DRAWINGS SHALL BE INCLUDED AS PART OF THE MECHANICAL WORK.
5. UNLESS NOTED OTHERWISE, STARTERS, SMOKE DETECTORS, TRANSFORMERS, CONTROLS AND CONTROL WIRING REQUIRED FOR ALL MECHANICAL SYSTEMS SHALL BE FURNISHED AND INSTALLED BY THE MECHANICAL CONTRACTOR.
6. ALL MECHANICAL EQUIPMENT SHALL BE INSTALLED ACCORDING TO MANUFACTURER'S RECOMMENDATIONS.
7. DUCT SHALL BE SIZED AT 0.1"/100 FT STATIC PRESSURE DROP WHERE A SIZE IS NOT NOTED ON DRAWINGS. FLEXIBLE DUCTWORK SHALL BE INSTALLED AS STRAIGHT AS POSSIBLE, AND SHALL BE ROUTED AND SUPPORTED WITHOUT FORMING CRIMPS OR OTHER AIR FLOW RESTRICTIONS. PROVIDE SQUARE TO ROUND ADAPTERS OR BOOTS TO CONNECT TO AIR DEVICE NECK WHEN REQUIRED.
8. ROUND AND FLEXIBLE DUCTWORK SHALL BE CONNECTED TO MAIN DUCTS WITH SPIN-IN FITTINGS WITH BALANCING DAMPERS.
9. ALL WORK SHALL BE COORDINATED AND PERFORMED WITH PRIOR APPROVAL FROM THE OWNER TO SUIT HIS OPERATING CONDITIONS.
10. CONTRACTOR SHALL COORDINATE THE INSTALLATION OF ALL MECHANICAL EQUIPMENT, DUCTWORK, ETC. TO FIT WITHIN THE SPACE ALLOWED BY THE ARCHITECTURAL AND STRUCTURAL CONDITIONS. CUTTING OR OTHERWISE ALTERING ANY STRUCTURAL MEMBERS SHALL NOT BE PERMITTED WITHOUT WRITTEN PERMISSION FROM THE ARCHITECT. IN GENERAL, DUCTWORK SHALL BE ROUTED AS HIGH AS POSSIBLE. PROVIDE ALL OFFSETS REQUIRED TO MAINTAIN ARCHITECTURAL CEILING HEIGHTS AND OPEN SPACE CLEARANCES. THIS INCLUDES ANY OFFSETS NOT SPECIFICALLY SHOWN ON THE DRAWINGS. OFFSETS SHOWN ARE DIAGRAMMATIC AND ARE NOT MEANT TO INDICATE THE ONLY OFFSETS REQUIRED.
11. MOUNT THERMOSTATS 4' - 4" AFF UNLESS NOTED OTHERWISE. PROVIDE SPACE TEMPERATURE SENSORS FOR THERMOSTATS LOCATED IN CORRIDORS.
12. LOCATIONS OF GRILLES, REGISTERS, & DIFFUSERS SHOWN ON THE DRAWINGS ARE APPROXIMATE. COORDINATE EXACT LOCATIONS WITH LIGHTS, CEILING GRID, ETC.
13. PROVIDE ACCESS PANELS IN NON-ACCESSIBLE CEILINGS AND IN WALL STRUCTURE TO ALLOW ADEQUATE ROOM FOR MAINTENANCE OF EQUIPMENT AND BALANCING OF SYSTEM.
14. ACCESS DOORS IN CEILINGS/WALLS SHALL BE A MINIMUM OF 12X12, HINGED, AND FIRE RATED TO MATCH CEILING/WALL RATING. DUCT ACCESS DOORS SHALL BE DOUBLE WALL IF INSTALLED ON SUPPLY DUCT, AND PROVIDED WITH THUMB LATCHES FOR AN AIR TIGHT FIT.
15. PROVIDE MVDs AT TAKE-OFFS, WHERE ACCESSIBLE CEILING (LAY-IN) IS PROVIDED, OF RUNOUTS TO DIFFUSERS AND WHERE SHOWN ON PLANS. WHERE BALANCING DAMPERS ARE ALSO PROVIDED AT THE TAKE-OFF (NOT AT GRILLE), GRILLE DAMPER SHOULD BE 100% OPEN AFTER TEST AND BALANCE.
16. DUCT ROUTING, OFFSETS AND LOCATIONS ARE DIAGRAMMATIC. EXACT LOCATIONS, ELEVATIONS, AND OFFSETS SHALL BE DETERMINED FROM COORDINATION DRAWINGS PRODUCED FROM A COMPOSITE OF ARCHITECTURAL, STRUCTURAL AND OTHER TRADE'S DRAWINGS. ROUTE DUCT HIGH AS POSSIBLE. SEE SPECIFICATIONS FOR COMPLETE MULTI TRADE COORDINATION DRAWING REQUIREMENTS.
17. APPLIANCES SHALL BE ACCESSIBLE FOR INSPECTION, SERVICE, REPAIR AND REPLACEMENT WITHOUT DISABLING THE FUNCTION OF A FIRE-RESISTANCE RATED ASSEMBLY OR REMOVING PERMANENT CONSTRUCTION, OTHER APPLIANCES, VENTING SYSTEMS OR ANY OTHER PIPING OR DUCTS NOT CONNECTED TO THE APPLIANCE BEING INSPECTED, SERVICED REPAIRED OR REPLACED. A LEVEL WORKING SPACE AT LEAST 30" DEEP AND 30" WIDE SHALL BE PROVIDED IN FRONT OF THE CONTROL SIDE TO SERVICE AN APPLIANCE PER IMC MECHANICAL CODE SECTION 306.1.

HVAC LEGEND

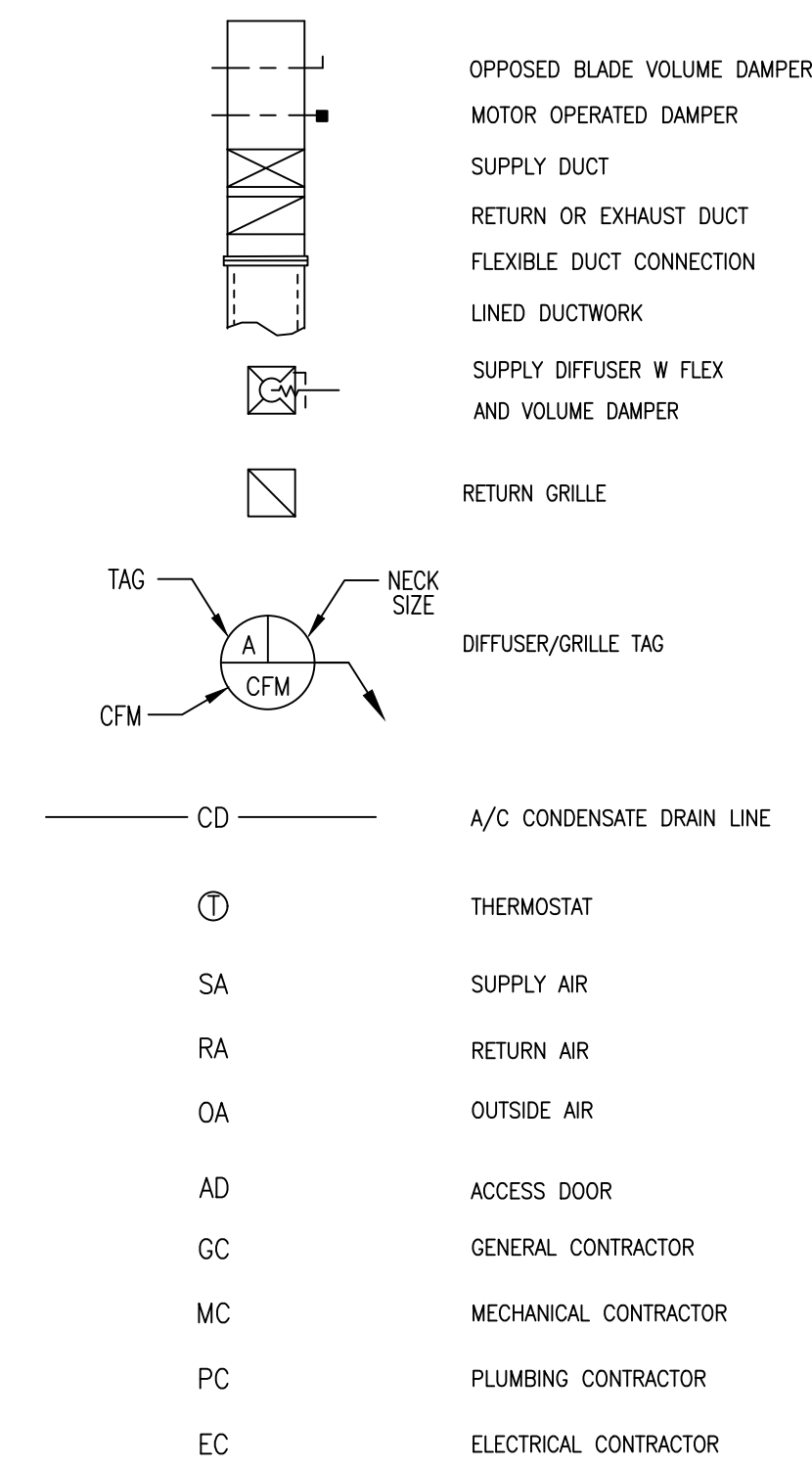

DRAWING M001

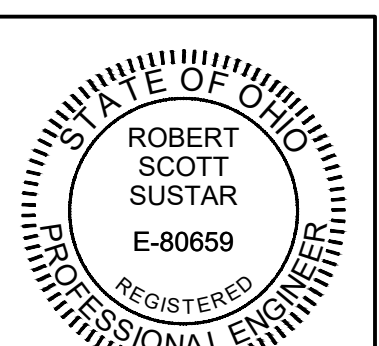

Table with columns: DATE (04-06-2026), DESCRIPTION, BID/FERMIT, REV. NO. (1)

MENTOR MUNICIPAL MAINTENANCE HVAC REPLACEMENT
6845 HOPKINS RD. MENTOR OH 44060

DENK ASSOCIATES logo and address: 503 EAST 200th STREET, CLEVELAND OH 44149-1574, PHONE: 216-531-8880, EMAIL: info@denkassocs.com

Table with columns: MECHANICAL LEGENDS, SCHEDULES AND NOTES, APPROVED: MTD, DRAWN: SCS, AS NOTED, DATE: April 6, 2026, JOB NO. 28029

DRAWING M001

BUILDING AUTOMATION SPECIFICATION

PART 1 BUILDING AUTOMATION SYSTEM

1.1 GENERAL

- A. This section describes the Integrated Building Management System (IBMS) technical and/or products specification to be undertaken by the IBMS Contractor.
B. Portions of work described in this section but which may not be further detailed in other sections of the IBMS specifications shall not relieve IBMS Contractor his obligation to carry out the mentioned works.

1.2 SCOPE OF WORK

- A. Furnish and install Niagara (Tridium) Framework IBMS software, workstations, and JACE controllers compliant with the specifications herein consisting of:
1. JACE controllers as necessary to integrate with existing BACnet, that shall remain in place and be reused as shown on the drawings.
2. ALL JACE controllers provided under this specification shall conform to the Niagara 'Nikon open JACE' profile to enable any certified Niagara contractor the ability to make full changes to the system.
3. The IBMS shall utilize A SINGLE 'Niagara 4 or later revision JACE 8000 controller(s)', networked with a Niagara Framework Web Supervisor (when multiple JACEs are necessary to address the point counts and resource limitations) and identify device type for existing or new systems control devices.
4. The work shall include the IBMS for the (Fill in Project Name)
5. Any and all wiring changes necessary in accordance with Part 3 (Execution) and Part 4 (Sequences of Operation) of these Specifications.
B. Furnish and install new BACnet BTL Listed Controls for the control of the following equipment subject to the 'Minimum controller requirements' of paragraph 1.4.
1. Rooftop Units (See Points List Section 4.3)
a. (5) Packaged CAU/WT with OEM Economizer
2. WT Dampers (See Points List, Section 4.4)
C. CONTROL WIRING
1. The IBMS Contractor shall furnish all electrical control and interlock wiring connected to the controls and instrumentation systems.
2. All conduits in connection with the controls and instrumentation system shall be furnished and installed by this Contractor. Such works shall conform to the applicable requirements of the Electrical Wiring standards for this project.
D. The Contractor shall complete all sensing and control installations including electrical and electronic components, not the Mechanical Contractor, unless otherwise required.
E. Provide a comprehensive operator and technician-training program as described herein.
F. Provide as-built documentation, software, and all DDC control logic and all associated support documentation on approved media, which accurately represents the final installed system.

1.3 COORDINATION WITH OTHER TRADES AND DIVISIONS

- A. 110 VAC or greater voltage power wiring to main control panels (i.e. AHUs) as shown on the mechanical plans and/or specifications, shall be provided by the Electrical Contractor, and coordinated by this Contractor. Failure of the IBMS Contractor to coordinate requirements with other Divisions shall result in the IBMS Contractor to be responsible for any non-coordinated items.
B. WT terminal box manufacturer shall provide a line voltage to 24VAC transformer of minimum 40VA rating to supply control power to WT terminal controls. The IBMS manufacturer shall be responsible for all low voltage control wiring of the WT terminal unit controllers and coordinate such wiring with the terminal unit manufacturer as necessary.

1.4 MINIMUM SYSTEM REQUIREMENTS

- A. Subject to the provisions of the applicable individual types of equipment contained herein, furnish and install BACnet BTL Listed equipment, software, and devices compliant with the BACnet standard profiles indicated in the following minimum quantities specified as follows:
1. Operator Workstation - consisting of Niagara 'Supervisor' software and web-based operator workstation at the Niagara 4 level or latest available released version, installed on (1) Server(s) + (1) Workstation(s) at the location(s) shown on the drawings. Software shall be BACnet BTL Listed as a 'BACnet Advanced Operator Workstation' under the B-NAC profile.
2. Niagara 'Supervisor' Engineering Toolkit - Provide all Engineering Workstation and application development software from the IBMS manufacturer necessary to allow the Owner complete access for the programming of additional points, sequences of operation, web graphical pages, and other tools needed to expand or modify the system as needed. Provide software copies or server workstation installation as needed to allow properly authorized users access to the software on designated Engineering Workstations.
3. Niagara Laptop Engineering Toolkit - Provide all Engineering Workstation software and network interface tools as needed from the IBMS manufacturer necessary to allow the Owner complete access via a laptop computer for the programming, configuration, and modification of field controllers. Generation of new web graphics for this level of tool are NOT needed. Provide (1) licensed copy of this toolkit for each required laptop service tool according to the specifications.
4. BACnet Routers (B-RTU profile) - Install a minimum of (1) BACnet router per floor level and not more than 1 router per 62 MS/IP devices. If more than 31 MS/IP devices are connected to one router, then provide an MS/IP repeater device after every 31 MS/IP devices on the sub-network OR at every 'T' in the MS/IP trunk wiring, whichever quantity is GREATER.
5. BACnet Building Controllers (B-BC profile) - Furnish and install a minimum of (1) B-BC for control of
a. Each central chilled water or hot water plant room exceeding 80 physical points of capacity. If co-located, one controller may be used for the entire plant room if capacity permits according to the points schedule.
6. BACnet Advanced Application Controllers (B-AAC profile) - Furnish and install a minimum of (1) BACnet Advanced Application Controllers (B-AAC) for the control of:
a. WT terminal units - 1 Controller per WT terminal used in room pressurization applications along with associated independent or dependent control supply/exhaust terminal controller.
b. Other controlled and monitored systems - 1 controller per each system interface location
7. BACnet Application Specific (B-ASPC profile) - Furnish and install a minimum of (1) BACnet Application Specific Controllers for the control of EACH
a. Packaged Unitary < = 68KW (20 Ton) Capacity meeting the sequences of operation specified
b. Single duct CAU/WT terminal units without reheat
8. Digital Room Sensors (DRS) with display - Furnish and install Manufacturer's compatible Digital Room Sensors with LCD display at each location shown on the drawings or as specified in the points list. At a minimum, provide 1 DRS sensor Per VAV terminal, FCU, or packaged unitary equipment unit (if controller does not have built in equipment display).

1.5 QUALIFICATION OF IBMS SUPPLIERS/BRAND NAME REFERENCES

- A. Any reference in this Specification to brand names or to a specific manufactured product without the use of 'or approved equal' is to be interpreted to mean that the specific article or product is the only one to be supplied or used.
B. All approved bidders must be Systems Integrators and specialty control contractors in the business of installing Niagara Framework based IBMS systems and direct digital temperature controls.
1. The Niagara Framework IBMS/DDC control contractor shall provide evidence of certification of his engineers/technicians that will be assigned to the project. At a minimum, the Project Engineer shall be registered as a currently certified Niagara Framework Engineer.
2. The Niagara Framework IBMS/DDC control contractor shall provide evidence of a successful track record of implementation of Niagara framework projects by submitting the project name and reference contact information for a minimum of 3 projects so the Consultant/Owner may qualify their bid capabilities.
3. Subject to the provisions of these specifications, provide a Niagara Framework IBMS/DDC/control system from one of the following manufacturers:
a. KMC Controls by Gardiner(Adam Horace ahorace@mgardiner.com cell 216-217-2996)
b. Johnson Controls - Shall be listed on bid form
c. Siemens Building Technologies - shall be listed on bid form
C. Components used for this project including control damper actuators, sensors, switching devices, and other accessories shall be provided from one of the manufacturers named above or the following listed manufacturers:
1. Control Actuators & Control Valves - Belimo
2. Room, duct, pipe, outside ambient temperature, pressure and humidity - Greystone Energy, Mamco, Carlo Gavazzi, Automation Components
D. Only vendors named in this specification or pre-approved by addendum shall be acceptable.
E. All manufacturers not named in paragraph 1.5.B above desiring to bid this project shall obtain the Engineer's pre-approval not less than 1 week prior to bid day by a pre-submission of:
1. The BACnet Testing Laboratory (BTL) certification listing (available at www.bacnetinternational.org website) of each model device that will be used to comply with the requirements of section 1.4.
2. A copy of the testing submission letter for the product from the manufacturer to BTL for those products in testing at BTL and awaiting approval.
3. The manufacturer shall submit a list of exact models and quantities to be provided to show compliance with the intent of section 1.4 for review and acceptance by the Consulting Engineer. Each of these models shall be listed on the BTL certification website or the manufacturer shall submit a copy of the BTL test submission letter as described in sub-paragraph 2 above.
4. A copy of the Niagara certifications of their Technical employees that will be used to implement the project at site.
5. A Minimum of 3 completed Niagara framework project references listing the project name, scope of works, and contact information of the end user qualified to comment on the quality of workmanship and execution of the projects.
6. For components, submit manufacturer's datasheet and written explanation from IBMS contractor of why suggested alternative is superior to the listed named vendors.
F. All HVAC equipment manufacturers desiring to provide a 'package price' of HVAC equipment inclusive of the complete IBMS/DDC controls system are specifically required to provide separate prices for the equipment less controls. The equipment vendor shall provide a separate proposal for the IBMS inclusive of all HVAC equipment controllers, sensors, actuators, control valves, operator workstations and other devices necessary for a complete and functional IBMS system as stipulated by the requirements of this specification. Any equipment supplier that will NOT break out the controls portion of his 'package bid price will be excluded from providing BOTH controls AND equipment.
G. All bidders shall be factory owned branch office or factory authorized and Certified Systems Integrator of the manufacturers specified.
H. All bidders shall have a local engineering and service office within 50 miles of the job site and/or be able to remotely access a

system via the internet within one working day to diagnose system problems or issues via the internet.

1.6 UNACCEPTABLE PRODUCTS

- Subject to the re-use of existing controls and sub-systems that may remain in use as part of a 'legacy installation' and may require integration to the new or expanded Niagara Framework system via new or existing JACE Network Controllers, or as specifically identified below, NO ADDITIONAL CONTROL DEVICES OF THE FOLLOWING TYPES SHALL BE ALLOWED.
A. LONMARK Products - NO LON DEVICES OR GATEWAY DEVICES SHALL BE ACCEPTABLE.
B. GATEWAY Products - Other than those gateways specifically defined in Section 1.2.C.1, NO OTHER GATEWAY DEVICES SHALL BE ACCEPTABLE.
C. PROPRIETARY Products - NO PROPRIETARY COMMUNICATION PRODUCTS SHALL BE ACCEPTABLE.
D. HVAC EQUIPMENT MANUFACTURER FACTORY MOUNTED CONTROLS - HVAC Equipment manufacturers that desire to provide equipment with factory mounted controls shall only provide controls from one of the NAMED MANUFACTURERS OF SECTION 1.5.B.
MANDATORY SYSTEM & QUALITY REQUIREMENTS

1.7 MANDATORY SYSTEM & QUALITY REQUIREMENTS

- A. All Niagara Framework devices shall be new and of the Niagara 4 level or latest available, released version. This shall include the Niagara Supervisor software and accessories and JACE 8000 controllers. Niagara Framework controllers shall ONLY be utilized at the I/P level, to integrate existing 'legacy systems' that will be maintained, and to integrate new BACnet IBMS controllers installed under this contract in the 'new' portion of the works.
B. All 'New' IBMS controllers shall strictly adhere to the following characteristics:
1. The controller shall consist of native BACnet, direct digital control, microprocessor-based, real-time clock, peer-to-peer, networked, energy management, distributed devices utilizing the ASHRAE/ANSI standard 135 BACnet, communication protocol in an open, interoperable system. All controllers shall be BACnet Testing Laboratories (BTL) Listed at standard revision 2008 or later and PICs statements available on the BTL website.
2. The BACnet operating stack must be embedded directly in every device at the board level and in all operator interface software packages.
3. With the exception of those gateways identified in Section 1.2.C.1 no Gateways, Communication Bridges, Protocol Translator or any other device that translates any proprietary or other communication protocol to the BACnet communication protocol shall be permitted as a part of the installation pursuant with this specification section.
4. Controllers and software used on this project shall be newly manufactured products the manufacturer is currently manufacturing and selling for use in new installations. Do not use this installation as a product test site unless explicitly approved in writing by Owner. Spare parts shall be available for at least five years after completion of this contract.
5. Each of controller hardware shall be suitable for anticipated ambient conditions and rated for a minimum of 32 - 122F (0 - 50C).
6. The IBMS contractor must provide a PICs document showing the proposed & installed systems compliance level to the ANSI/ASHRAE Standard 135-2008 or later revision for all BACnet devices.

- B. Control Components & Accessories - All control components and accessories used for this project shall be newly manufactured and supplied by the IBMS contractor from one of the named manufacturers of paragraph 1.5.C or as approved by Addendum in paragraph 1.5.E.

- C. Quality Standards - As control devices and components shall meet the following quality and standards for use in commercial buildings as appropriate:
1. Digital controllers and systems NOT used in 'smoke control applications' - UL Standard 916, Category PA2X (Energy Management standard)
2. Control components using voltages > 24VAC Nominal voltage - UL Standard 873 (Temperature Indicating and Regulating)
3. Control components using voltages < = 24VAC Nominal voltage - UL 873 or UL Component recognized (ULR)
4. FCC Part 15, Sub-Part A
5. Uniform Building Code (UBC), including local amendments
6. National Electrical Code (NEC)

1.8 SUBMITTALS

- A. Submit under provisions of this Section

- B. Product Data: Manufacturer's data sheets on each product to be used, including:
1. Preparation instructions and recommendations.
2. Storage and handling requirements and recommendations.
3. Installation methods.

C. Drawings:

- 1. The system supplier shall submit engineered drawings, control sequence, and bill of materials for approval.
2. Drawings shall be submitted in the following standard sizes: 11 x 17 inch (ANSI B).
3. One(1) complete sets (copies) of submittal drawings shall be provided.
4. Drawings shall be available on CD-ROM or Flash Drive

- D. System Documentation: Include the following in submittal package:
1. System configuration diagrams in simplified block format.
2. All input/output object listings and an alarm point summary listing.
3. Electrical drawings that show all system internal and external connection points, terminal block layouts, and terminal identification.
4. Complete bill of materials and damper schedule.
5. Manufacturer's instructions and drawings for installation, maintenance, and operation of all purchased items.
6. Overall system operation and maintenance instructions-including preventive maintenance and troubleshooting instructions.
7. For all system elements-operator's workstations, building controllers, application controllers, routers, and repeaters-provide BACnet Protocol Implementation Conformance Statements (PICS) as per ANSI/ASHRAE Standard 135.
8. A list of all functions available and a sample of function block programming that shall be part of delivered system.
9. Product Warranty - Submit Manufacturer's standard product warranty statement. Products NOT meeting the requirements of Paragraph 1.9 below shall be rejected OR the IBMS contractor shall stipulate in his proposal that he fully complies with the cost provisions of paragraph 1.9 and he has included any additional replacement costs in his price.

1.9 Project Warranty

- A. Material Warranty - The selected manufacturer of IBMS controllers and components shall be provided with a 5 year manufacturer's replacement warranty from the date of manufacture. IBMS contractor shall not utilize any products with a warranty manufacture date of less than 4 years from the date of the start of construction of the project.
B. Labor Warranty - The selected IBMS contractor shall provide a full project warranty in accordance with the Warranty provisions of the General Conditions and Defects Liability Period of the project.

BAS INPUTS/OUTPUTS

THE FOLLOWING POINT INFORMATION SHALL BE AVAILABLE AND ADJUSTABLE ON THE NEW BUILDING AUTOMATION SYSTEM.

BUILDING AUTOMATION CONTRACTOR SHALL REVIEW EXISTING CITY OF MENTOR BAS AND SETUP NEW SCREENS AND CONTROL POINTS SIMILAR TO THE EXISTING SYSTEM IN OPERATION.

ALL ROOFTOP UNITS - RTU-1, RTU-2, AND RTU-3

Table with 2 columns: OCCUPIED COMMAND: and ALARM RELAY STATUS: with values for Occupied, Unoccupied, Normal, Diagnostics, on/off, 3 minute.

Table with 2 columns: Economizer Position and Economizer Min. Pos. Setpoint with values for % and F.

Table with 2 columns: Economizer Enable Setpoint and Economizer Min. during heat with values for F.

Table with 2 columns: Optimal Start Upper Limit and Optimal Start Lower Limit with values for F.

Table with 2 columns: Heat/Cool mode request: Stage 1 Cool, Stage 2 Cool, Stage 1 Htg, Stage 2 Htg and RTU Mode Override: Stage 1 Cool, Stage 2 Cool, Stage 1 Htg, Stage 2 Htg.

ROOFTOP UNITS - RTU-1, RTU-2 and RTU-3 INCLUDE A VARIABLE VOLUME VARIABLE TEMPERATURE ZONED SYSTEM WITH BYPASS

WT BYPASS DAMPER STATUS

Table with 2 columns: Discharge Air Temperature and Bypass Damper Position % open with values for F and %.

SPACE STATUS

Table with 2 columns: Average Space Temperature and Minimum Strong Votes to Changeover with values for F and %.

WT ZONE INFORMATION

Table with 2 columns: Occupied status Mode and Air Valve open % with values for Space temperature, F, and %.

WT ZONE DAMPER - EACH INDIVIDUAL DAMPER

Table with 2 columns: STATUS and LOCAL SETPOINT SETTINGS with values for Occupied Request, Heating Setpoint High Limit, Minimum Setpoint Difference, Unoccupied Cooling Setpoint, Unoccupied Heating Setpoint.

AIR FLOW SETTINGS

Table with 2 columns: Damper Position (%) and Air Flow Settings with values for Actual Airflow, Airflow Setpoint, Maximum Cooling Flow, Minimum Cooling Flow, Maximum Heating Flow, Minimum Heating Flow.

GRAPHICS

Table with 2 columns: WT Designation, % open and Air Volume in CFM with values for % and CFM.

GENERAL

Table with 2 columns: SPACE CONDITIONS and Active Space Cooling Setpoint with values for Space Temperature, Active Space Heating Setpoint, Setpoint Offset, Occupied Cooling Setpoint, Occupied Heating Setpoint, Outdoor Air Temperature, Outdoor Air Humidity.

SEQUENCE OF OPERATION

- 1. Single Zone Rooftop Unit Sequence of Operation(RTU-1, RTU-2 and RTU-3)

Run Conditions - Schedule: The unit shall run according to a user definable time schedule in the following modes:

- Occupied Mode: The unit shall maintain
• A 72F (adj.) cooling setpoint
• A 74F (adj.) heating setpoint.
• Unoccupied Mode (night setback): The unit shall maintain
• A 85F (adj.) cooling setpoint.
• A 55F (adj.) heating setpoint.

Alarms shall be provided as follows:

- High Zone Temp: If the zone temperature is greater than the cooling setpoint by a user definable amount (adj.).
• Low Zone Temp: If the zone temperature is less than the heating setpoint by a user definable amount (adj.).

Zone Setpoint Adjust: The occupant shall be able to adjust the zone temperature heating and cooling setpoints at the zone sensor.

Zone Optimal Start: The unit shall use an optimal start algorithm for morning start-up. This algorithm shall minimize the unoccupied warm-up or cool-down period while still achieving comfort conditions by the start of scheduled occupied period.

Zone Unoccupied Override: A timed local override control shall allow an occupant to override the schedule and place the unit into an occupied mode for an adjustable period of time. At the expiration of this time, control of the unit shall automatically return to the schedule.

Freeze Protection: The unit shall shut down and generate an alarm upon receiving a freestest status.

Return Air Smoke Detection: The unit shall shut down and generate an alarm upon receiving a return air smoke detector status.

Supply Fan: The supply fan shall run anytime the unit is commanded to run, unless shutdown on safeties. To prevent short cycling, the supply fan shall have a user definable (adj.) minimum runtime.

Alarms shall be provided as follows:

- Supply Fan Failure: Commanded on, but the status is off.
• Supply Fan In Hand: Commanded off, but the status is on.
• Supply Fan Runtime Exceeded: Status runtime exceeds a user definable limit (adj.).

Zone Temperature Control: The controller shall measure the zone temperature and shall modulate the supply fan VFD speed to maintain zone temperature setpoint. The fan speed shall increase as the zone temperature rises above cooling setpoint, or as the zone temperature drops below heating setpoint.

Alarms shall be provided as follows:

- High Supply Air Static Pressure: If the supply air static pressure is 25% (adj.) greater than setpoint.
• Low Supply Air Static Pressure: If the supply air static pressure is 25% (adj.) less than setpoint.

Cooling Stage: The controller shall measure the zone temperature and stage the cooling to maintain its cooling setpoint. To prevent short cycling, the stage shall have a user definable (adj.) minimum runtime.

The cooling shall be enabled whenever:
• Outside air temperature is greater than 60F (adj.).
• AND the economizer (if present) is disabled or fully open.
• AND the zone temperature is above cooling setpoint.
• AND the supply fan status is on.
• AND the heating is not active.

Gas Heating Stages: The controller shall measure the zone temperature and stage the heating to maintain its heating setpoint. To prevent short cycling, there shall be a user definable (adj.) delay between stages, and each stage shall have a user definable (adj.) minimum runtime.

The heating shall be enabled whenever:
• Outside air temperature is less than 65F (adj.).
• AND the zone temperature is below heating setpoint.
• AND the supply fan status is on.
• AND the cooling is not active.

Economizer: The controller shall measure the zone temperature and modulate the economizer dampers in sequence to maintain a setpoint 2F less than the zone cooling setpoint. The outside air dampers shall maintain a minimum adjustable position of 20% (adj.) open whenever occupied.

The economizer shall be enabled whenever:
• Outside air temperature is less than 65F (adj.).
• AND the outside air enthalpy is less than 22Btu/lb (adj.).
• AND the outside air temperature is less than the return air temperature.
• AND the outside air enthalpy is less than the return air enthalpy.
• AND the supply fan status is on.

The economizer shall close whenever:
• Mixed air temperature drops from 45F to 40F (adj.).
• OR on loss of supply fan status.
• OR freestest (if present) is on.

The outside and exhaust air dampers shall close and the return air damper shall operate as described in the occupied mode except that the outside air damper shall modulate to fully closed.

Minimum Outside Air Ventilation - Fixed Percentage: The outside air dampers shall maintain a minimum position (adj.) during building occupied hours and be closed during unoccupied hours.

Mixed Air Temperature: The controller shall monitor the mixed air temperature and use as required for economizer control (if present) or preheating control (if present).

Alarms shall be provided as follows:
• High Mixed Air Temp: If the mixed air temperature is greater than 90F (adj.).
• Low Mixed Air Temp: If the mixed air temperature is less than 45F (adj.).

Return Air Humidity: The controller shall monitor the return air humidity and use as required for economizer control (if present) or humidity control (if present).

Alarms shall be provided as follows:
• High Return Air Humidity: If the return air humidity is greater than 70% (adj.).
• Low Return Air Humidity: If the return air humidity is less than 35% (adj.).

Return Air Temperature: The controller shall monitor the return air temperature and use as required for economizer control (if present).

Alarms shall be provided as follows:
• High Return Air Temp: If the return air temperature is greater than 90F (adj.).
• Low Return Air Temp: If the return air temperature is less than 45F (adj.).

Supply Air Temperature: The controller shall monitor the supply air temperature.

Alarms shall be provided as follows:
• High Supply Air Temp: If the supply air temperature is greater than 120F (adj.).
• Low Supply Air Temp: If the supply air temperature is less than 45F (adj.).

Environmental Index: When the zone is occupied, the controller will monitor the deviation of the zone temperature from the heating or cooling setpoint. The controller will also monitor the relative humidity and compare it to comfort conditions. This data will be used to calculate a 0 - 100% Environmental Index which gives an indication of how well the zone is maintaining comfort. The controller will also calculate the percentage of time since occupancy began that the Environmental Index is 70% or higher. Optionally, a weighting factor can be configured to adjust the contribution of the zone to the rollup average index based upon the floor area of the zone, importance of the zone, or other static criteria.

DRAWING M002

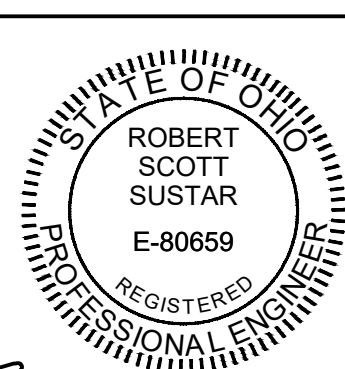

Professional Engineer signature and name.

Table with 4 columns: REV. NO., DESCRIPTION, DATE, and BID/FERMIT with values for 1, 04-06-2016.

MENTOR MUNICIPAL MAINTENANCE HVAC REPLACEMENT 6645 HOPKINS RD. MENTOR OH 44060

DENK ASSOCIATES logo and contact information: 503 EAST 200th STREET CLEVELAND OHIO 44119-1574 PHONE: 216-531-8880 EMAIL: info@denkassociates.com

Table with 4 columns: APPROVED: MTD, DRAWN: SCS, SCALE: AS NOTED, DATE: April 6, 2016, JOB NO. 26029.

DRAWING M002

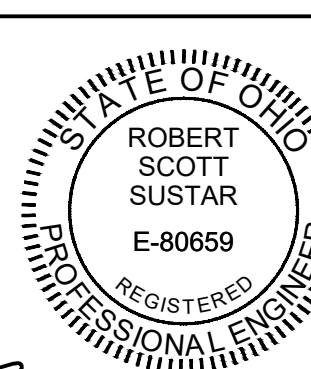

DATE: 04-06-2026

DESCRIPTION: BID/FERMIT

REV. NO. 1

MENTOR MUNICIPAL MAINTENANCE
HVAC REPLACEMENT

6645 HOPKINS RD.
MENTOR OH 44060

APPROVED: MTD

SCALE: AS NOTED

JOB NO. 26029

DATE: April 6, 2026

DRAWN: SCS

MECHANICAL/ELECTRICAL PLAN

DRAWING

M101

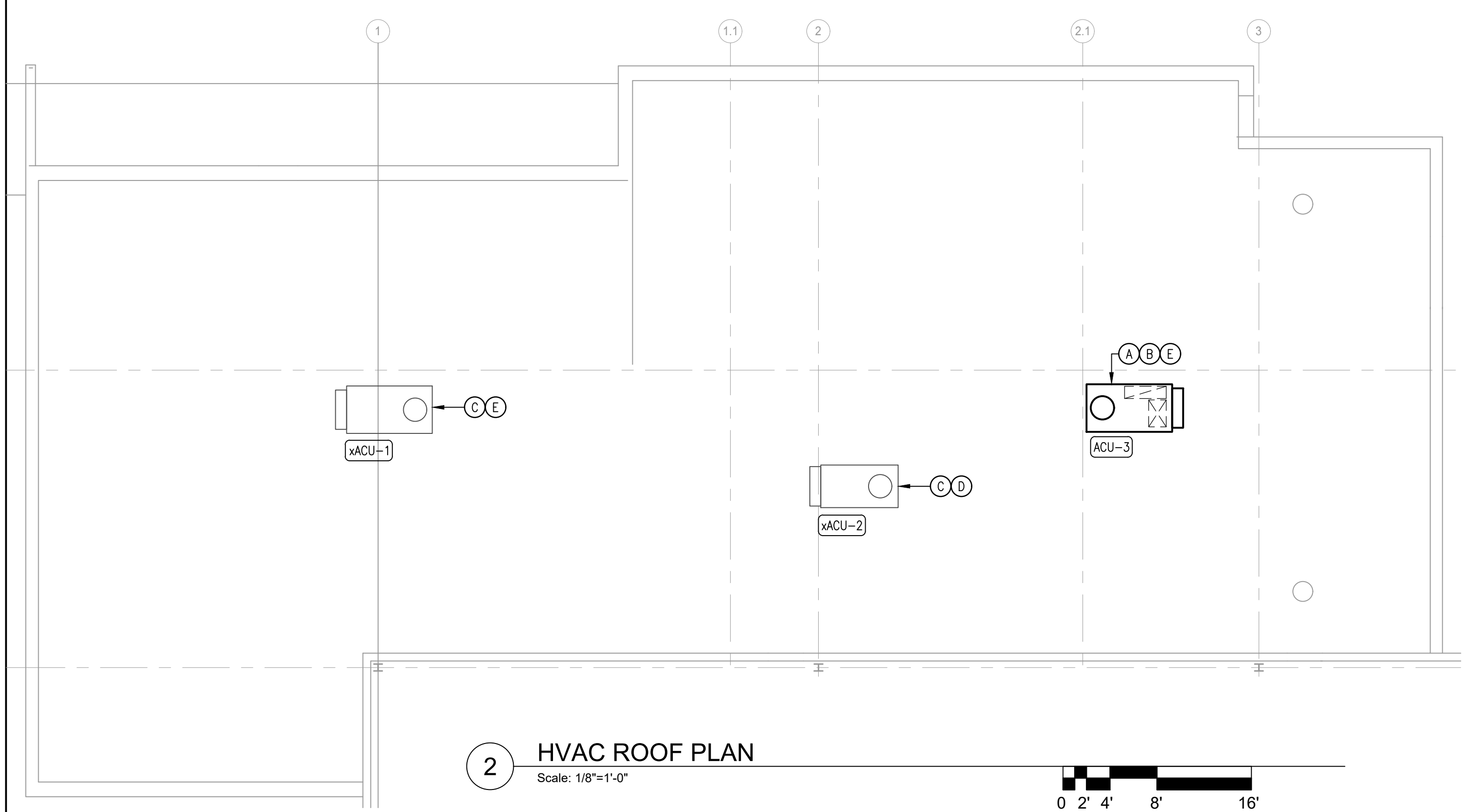

2 HVAC ROOF PLAN

Scale: 1/8"=1'-0"

HVAC ROOF PLAN CODED NOTES:

- A EXISTING ROOFTOP UNIT TO BE REMOVED AND REPLACED. NEW ROOFTOP UNIT TO HAVE SYMBIO CONTROLLER. RECONNECT AND RECONFIGURE EXISTING DUCTWORK AND CONNECTIONS FOR NEW UNIT.
- B CONDENSATE DRAIN FROM ROOFTOP UNIT TO INDIRECTLY CONNECT TO EXISTING ROOF DRAIN.
- C EXISTING ROOFTOP UNIT TO REMAIN.
- D EXISTING SYMBIO CONTROLS TO REMAIN WITH ROOFTOP UNIT.
- E EXISTING 3-4 CARD, NEW CONTROLLER WITH BACNET TO BE ADDED TO ROOFTOP UNIT.

HVAC NOTE:
ELECTRICAL RECONNECTIONS TO ROOFTOP UNIT SHALL BE BY M.C.

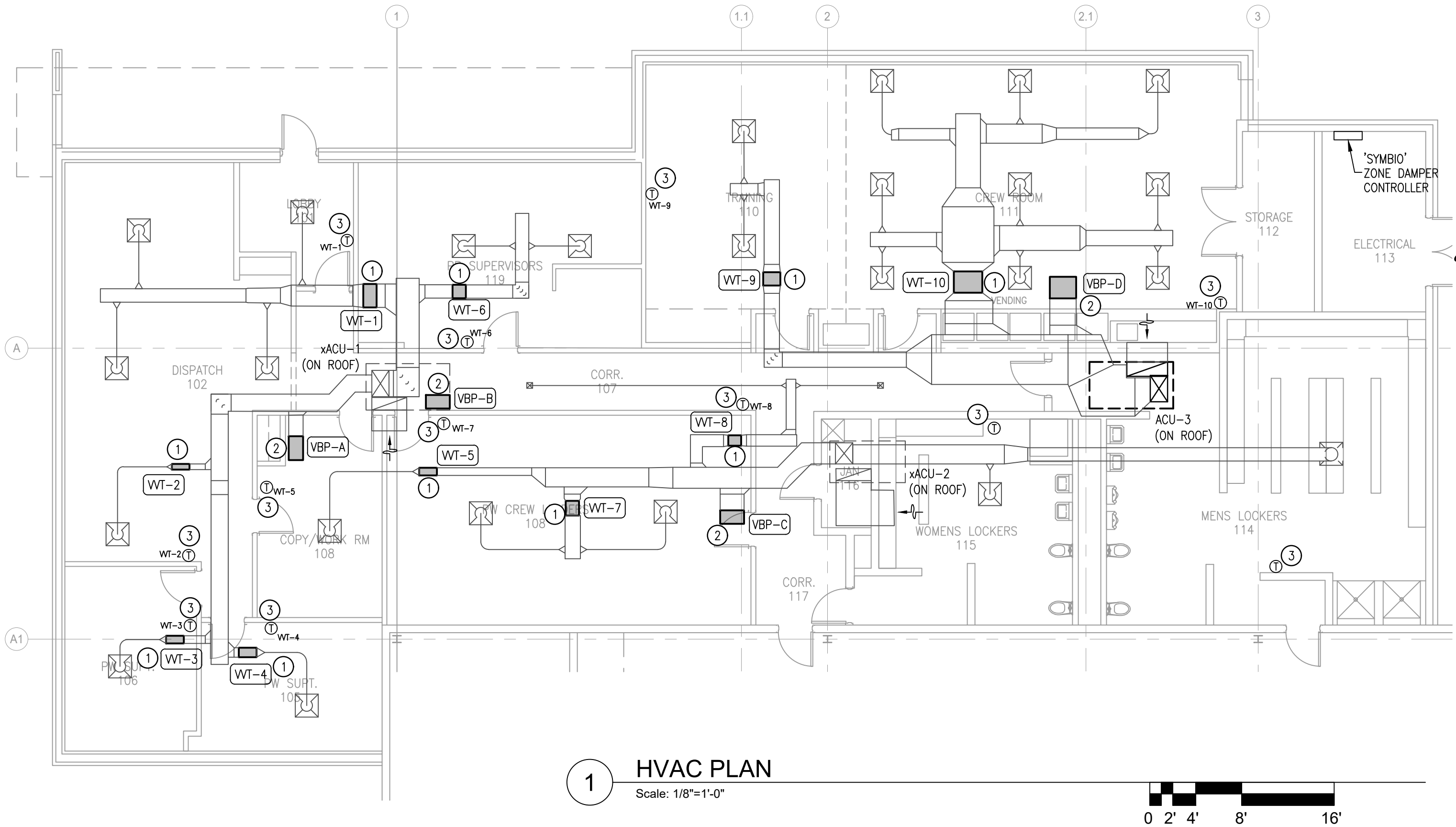

1 HVAC PLAN

Scale: 1/8"=1'-0"

HVAC PLAN CODED NOTES:

- 1 EXISTING WT ZONE DAMPER TO BE REMOVED AND REPLACED.
- 2 EXISTING WT BYPASS DAMPER TO BE REMOVED AND REPLACED.
- 3 EXISTING THERMOSTAT TO BE REMOVED AND REPLACED WITH NEW.

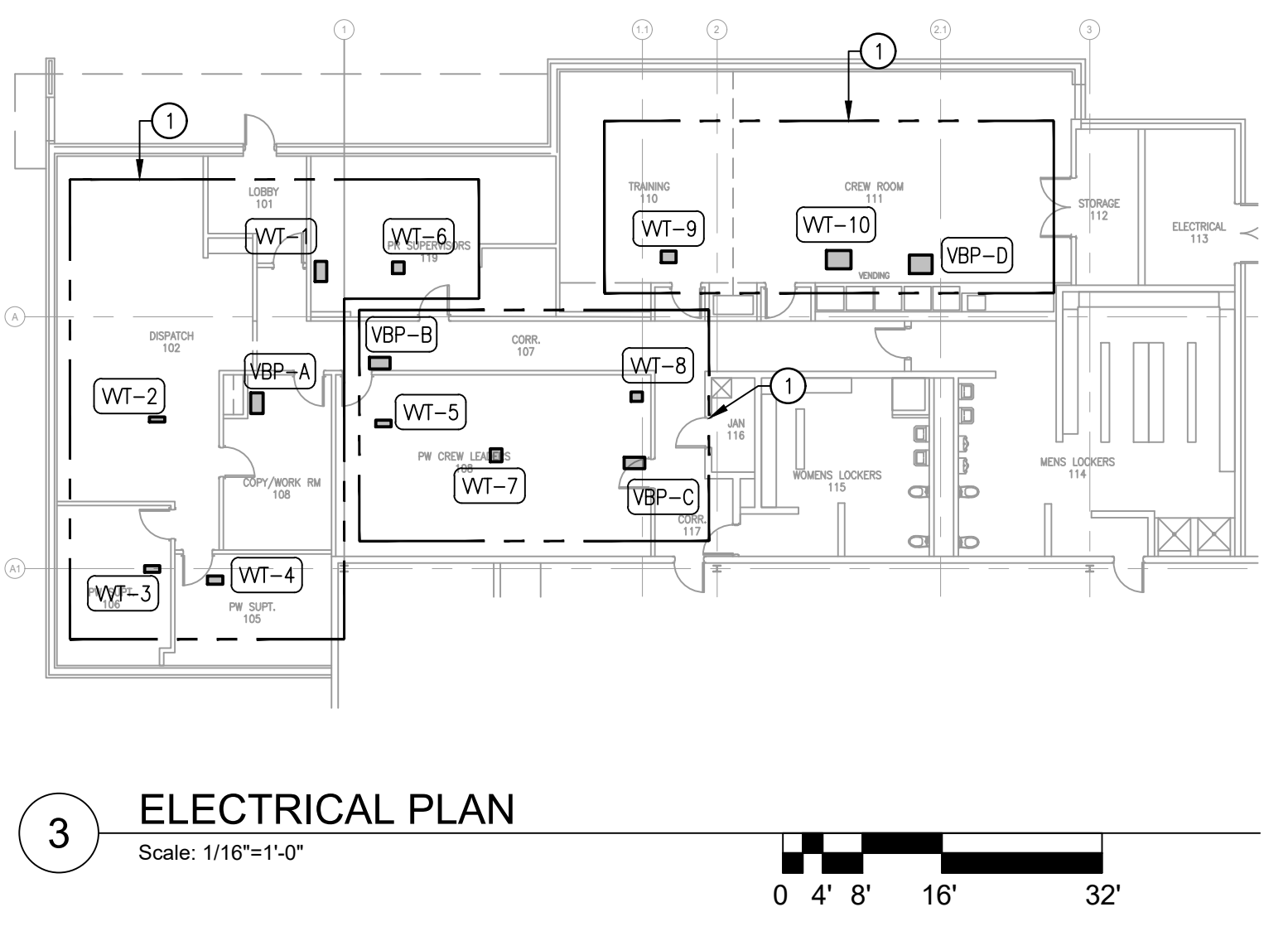

3 ELECTRICAL PLAN

Scale: 1/16"=1'-0"

ELECTRICAL PLAN CODED NOTES:

- 1 EACH ZONE DAMPER REQUIRES 24V WIRING FOR CONTROL POWER. PROVIDE ONE 115V CIRCUIT WITH APPROPRIATELY SIZED 24V TRANSFORMER FOR LOW VOLTAGE CONNECTION TO ALL TERMINAL BOXES. LOW VOLTAGE WIRING SHALL BE INSTALLED IN PLENUM RATED CABLE.

CONTROLS ALTERNATE BID

1. UNDER BID ITEM #01, PROVIDE AN ALTERNATE FOR CONTROLS WITH FRONT END CONSISTENT TO THE EXISTING CITY'S BAS. THIS SHOULD BE LISTED AS AN ADD/DEDUCT ALTERNATE. GARDINER BUILDING TECHNOLOGY PARTNERS IS THE BASE BID CONTROLS CONTRACTOR, THIS SHALL BE A NO-COST ALTERNATE. IF THE CONTRACTOR IS PROPOSING A SYSTEM THAT IS NOT GARDINER BUILDING TECHNOLOGY PARTNERS, THE CONTRACTOR SHALL LIST THE PROPOSED SYSTEM/MANUFACTURER AND THE PROPOSED ADD/DEDUCT TO THE BID.

2. IT IS THE OWNERS EXPRESSED GOAL FOR THE NEW CONTROLS TO BE INTEGRATED INTO THE EXISTING WEB SUPERVISOR. THE EXISTING CONTROLS AND WEB SUPERVISOR IN THE BUILDING IS A FRAMEWORK PROVIDED AND SERVICED BY GARDINER BUILDING TECHNOLOGY PARTNERS. THE CONTRACTOR SHALL PROVIDE NEW CONTROLS WITH THE APPROPRIATE CAPACITY AND LICENSING CAPABLE OF INTEGRATING THE EXISTING EQUIPMENT INTO THE WEB SUPERVISOR AND CONTROLS. THE CONTRACTOR SHOULD FIELD VERIFY THE EXISTING CONTROLS IN THE BUILDING.

HVAC System Replacement Scope of Work

Replace all VVT terminal boxes with new VVT terminal units.

All existing control wire shall be removed from ceiling. New temperature control wire shall be installed to all new terminal boxes.

All rooftops units to be connected to a Trane Symbio system.

All terminal units shall have the following:

- Control boards with with BACnet communications
- Temperature sensor - leaving air temperature
- Airflow (CFM) sensors
- Digital thermostats

All pneumatic controls/piping shall be cut and capped. Pneumatic controls shall remain in the system.

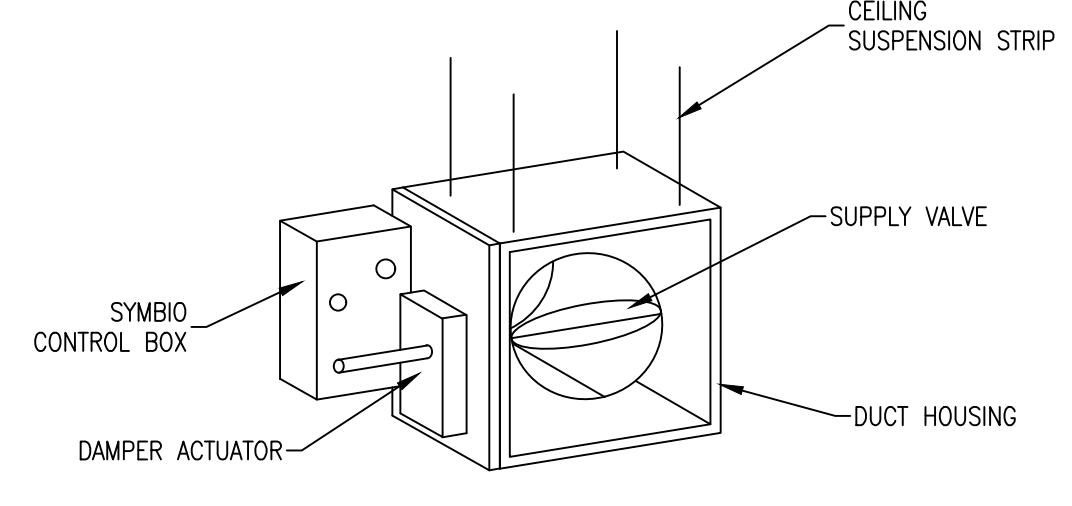

4 ZONE DAMPER DETAIL

NTS

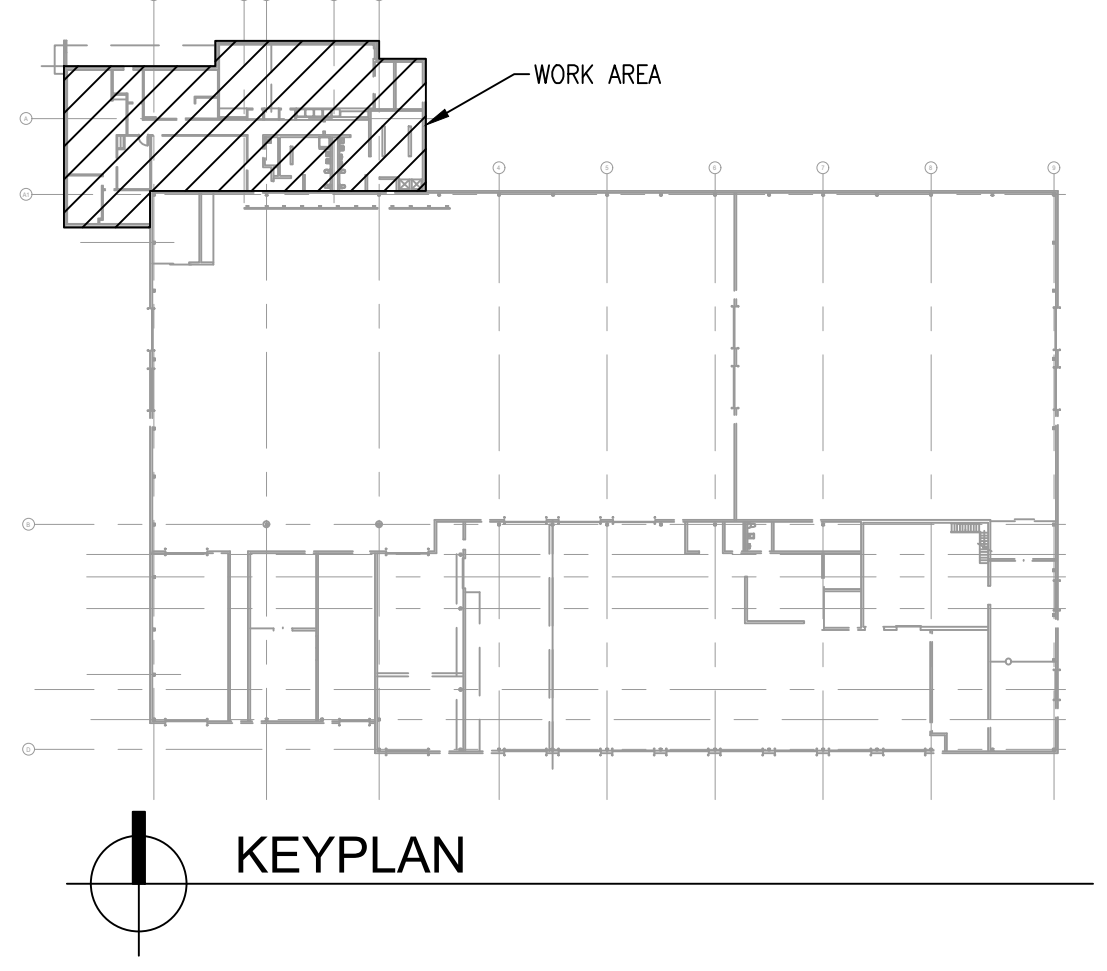

KEYPLAN

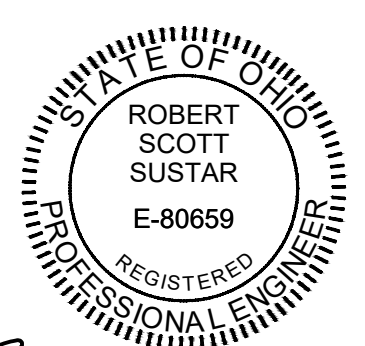

Robert Scott Sustar

ROOFTOP UNIT SCHEDULE																				
MARK	LOCATION	SERVICE	TONS	CFM	MIN. C.A. CFM	E.S.P.	SUPPLY FAN B.H.P.	RPM	MCA/MOCP	VOLTAGE	HEATING DATA CAPACITY (BTUS/HR)		COOLING DATA CAPACITY (BTUS/HR)		IEER	MANUFACTURER & MODEL NO.	UNIT SIZE	WEIGHT (LBS.)	REMARKS	
											INPUT	OUTPUT	TOTAL	SENS.						
XACU-1	ROOF	PERIMETER /OFFICES	EXISTING TO REMAIN																	1
XACU-2	ROOF	INT. OFFICES & TOIL/LOCKER	EXISTING TO REMAIN																	-
ACU-3	ROOF	TRAINING & CREW ROOM	12.5	4,500	336	0.6	2.2	1491	33A/45A	460V-3Ø	200,00	162,000	147,160	106,230	14	TRANE YSK150A4S0M	100"Lx63"Wx51"H	13760	1-13	

GAS PACKAGED ROOFTOP REMARKS:

- SYMBIO 700 UNIT CONTROLS WITH BACNET.
- COMMUNICATIONS OPTIONS: ADVANCED CONTROLS AND BACnet BAS.
- THROUGH THE BASE ELECTRIC ACCESS.
- NON-FUSED DISCONNECT SWITCH.
- ECONOMIZER, DB WITH BAROMETRIC RELIEF.
- 2" MERV8 FILTERS.
- CONDENSER WITH HAIL GUARD.
- GAS HEAT.
- SIDE OUTLET SUPPLY AND RETURN.
- DIRECT DRIVE AND HERMETIC TYPE COMPRESSORS.
- DIRECT DRIVE PLENUM FANS.
- BALANCE OUTDOOR AIR TO QUANTITY SHOWN.
- CURB ADAPTERS.

OUTDOOR AIR CALCULATION								
RTU MARK	ROOM	AREA/(NET-OCCUPIABLE AREA)	EST. OCCUPANT LOAD	OUTDOOR AIR FLOW RATE (CFM/PERSON)	AREA OUTDOOR AIR RATE (CFM/SF)	BREATHING ZONE OUTDOOR AIR FLOW	EZ	ZONE OUTDOOR AIRFLOW, VOZ
ACU-3	CREW ROOM 111	740	15	5	0.06	119	0.8	150
	TRAINING 110	407	10	10	0.12	149	0.8	186

- REMARKS
- BREATHING ZONE OUTDOOR AIRFLOW - VBZ = (RP)(PZ) + (RA)(AZ)
 WHERE:
 AZ = ZONE FLOOR AREA (SF)
 PZ = ZONE POPULATION, LARGEST NUMBER OF PEOPLE EXPECTED TO OCCUPY
 RP = PEOPLE OUTDOOR AIR RATE (OMC SECTION 403, TABLE 403.3)
 RA = AREA OUTDOOR AIR RATE (OMC SECTION 403, TABLE 403.3)
 - ZONE AIR DISTRIBUTION EFFECTIVENESS (EZ) 0.8 IS BASED ON TABLE 403.3.1.2; CEILING SUPPLY OF WARM AIR AND CEILING RETURN.
 - ZONE OUTDOOR AIRFLOW (VOZ): VOZ = VBZ/EZ

EXISTING ZONE DAMPER SCHEDULE			
MARK	INLET / OUTLET	MIN. MAX. CFM/CFM	MANUFACTURER & MODEL NO.
WT-1	24/8	0 / 1,185	CARRIER RD0824
WT-2	6"ø	0 / 235	CARRIER ZD-06
WT-3	8"ø	0 / 390	CARRIER ZD-08
WT-4	10"ø	0 / 450	CARRIER ZD-10
WT-5	8"ø	0 / 290	CARRIER ZD-08
WT-6	14/8	0 / 680	CARRIER RD0814
WT-7	14/8	0 / 760	CARRIER RD0814
WT-8	10/8	0 / 410	CARRIER RD0810
WT-9	18/8	0 / 830	CARRIER RD0818
WT-10	28/18/22	0 / 5,000	CARRIER PSA18
VBP-A	14"ø	0 / 850	CARRIER ZD-14
VBP-B	24/8	0 / 995	CARRIER RD0824
VBP-C	24/8	0 / 900	CARRIER RD0824
VBP-D	28/18/22	0 / 3,675	CARRIER PSA18

REPLACED ZONE DAMPER SCHEDULE			
MARK	INLET / OUTLET	MIN. MAX. CFM/CFM	MANUFACTURER & MODEL NO.
WT-1	24/8	0 / 1,185	TRANE VCCF24
WT-2	6"ø	0 / 235	TRANE VCCF06
WT-3	8"ø	0 / 390	TRANE VCCF08
WT-4	10"ø	0 / 450	TRANE VCCF10
WT-5	8"ø	0 / 290	TRANE VCCF08
WT-6	14/8	0 / 680	TRANE VCCF14
WT-7	14/8	0 / 760	TRANE VCCF14
WT-8	10/8	0 / 410	TRANE VCCF10
WT-9	18/8	0 / 830	TRANE VCCF18
WT-10	28/18/22	0 / 5,000	TRANE VCCF24
VBP-A	14"ø	0 / 850	TRANE VCCF14
VBP-B	24/8	0 / 995	TRANE VCCF24
VBP-C	24/8	0 / 900	TRANE VCCF24
VBP-D	28/18/22	0 / 3,675	TRANE VCCF24

- REMARKS:
- PROVIDE CENTRAL CONTROL PANEL.
 - PROVIDE THERMOSTAT WITH SET POINT FOR EACH DAMPER.
 - BYPASS DAMPER SHALL HAVE 0 CFM MIN. SETTING.
 - PROVIDE TEMPERATURE CONTROL TRANSFORMER.

HVAC INSULATION SCHEDULE			
SERVICE	THICKNESS	MATERIAL	JACKET
SUPPLY AIR DUCT (DUCTED RETURN) R-6 INSTALLED MINIMUM	2" 1-1/2" lb/cu-ft	MINERAL FIBER DUCT WRAP	FACTORY - FSK

ALL HVAC DUCT SYSTEMS SHALL BE INSULATED AS INDICATED UNLESS NOTED OTHERWISE. REFER TO SPECIFICATION SECTION 230700 FOR ADDITIONAL REQUIREMENTS.
 *INCLUDES ALL DUCTWORK TO AND FROM ERVs AND DGAS UNITS. INCLUDES ANY DUCT CONTAINING PREVIOUSLY CONDITIONED AIR.

DATE	04-06-2026
DESCRIPTION	BID/FERMIT
REV. NO.	1

MENTOR MUNICIPAL MAINTENANCE
 HVAC REPLACEMENT
 6645 HOPKINS RD.
 MENTOR OH 44060

DENK ASSOCIATES
 CONSULTING ENGINEERS
 503 EAST 200th STREET
 CLEVELAND, OHIO 44119-1574
 PHONE: 216-831-8880
 EMAIL: info@denkassociates.com

MECHANICAL SCHEDULES	APPROVED: MTD	DATE: April 6, 2026
	DRAWN: SCS	
SCALE: AS NOTED	JOB NO. 26029	

SECTION 6
SPECIFIC PROJECT REQUIREMENTS

SPECIFIC PROJECT REQUIREMENTS

1) Contact During Bidding

All Questions during bidding should be addressed to Lorne Vernon, Facilities Superintendent who can be reached at the City of Mentor Public Works, 6645 Hopkins Road (440) 974-5781.

2) Taxes

The Contractor shall pay and/or withhold all sales, consumer, use, employment and other taxes (including the City of Mentor 2% income tax) paid or withheld by the Contractor in accordance with the Laws and Regulations of the United States, State of Ohio, and City of Mentor which are applicable during the performance of the work.

3) Working Hours

The standard work hours for this project shall be between the hours of 8:00 am and 5:00 pm unless specifically approved by the engineer. Work shall not be permitted nights, or on Saturday, Sunday, or legal holidays, without written permission of the City of Mentor.

4) Completion Dates

Equipment must be ordered within thirty (30) days after contract has been signed and fully executed. The completion date for this project is September 1, 2026.

5) Project Completion

All work including restoration and clean-up shall be completed no later than the contract completion date. Failure to complete all work within the allotted time will result in assessment of liquidated damages. Upon completion of all work and written notification of same by the Contractor, the Engineer and Owner will compile a punch list. The punch list will be sent to the Contractor. All punch list work shall be completed to the satisfaction of the Engineer and the Owner within 14 days after receipt of the punch list. Failure to complete the punch list work within the allotted time will result in assessment of liquidated damages.

6) Final Compliance and Submittals

The following forms and related sign-offs shall be documented in accordance with provisions of the contract. These forms shall be completed by the Contractor and approved by the Owner before final retainer is approved for release. Forms for Items A to E will be attached to the Contractor's executed copy of the contract.

- A. Certificate of Substantial Completion (To be submitted at time of Substantial Completion)
- B. Contractor's Certification of Completion
- C. Contractor's Affidavit of Prevailing Wage
- D. Consent of Surety Company for Final Payment
- E. Affidavit of Final Acceptance Date and Correction Period
- F. Certificate of Insurance verifying completed operations insurance coverage

SECTION 7
WAGE RATES

PREVAILING WAGES

The Contractor agrees that each individual employed by the Contractor or any subcontractor and engaged in work on the project under this Contract shall be paid the prevailing wage established by the Ohio Department of Commerce Division of Industrial Compliance. This shall occur regardless of any contractual relationship which may be said to exist between the Contractor or any subcontractor and such individual.

The Prevailing Wage Determination Schedule for this project is attached. If the Contractor needs a wage determination for any trade not included herein, he shall contact the Owner's Prevailing Wage Coordinator.

Prevailing Wage Project Registration

Public Authority Information

Owner/Public Authority Name City of Mentor

Department Division or Agency Public Works Department

Street Address 8500 Civic Center Blvd

Address 2

City, OH Mentor , OH

ZIP 44060

Email Kasky@cityofmentor.com

County of Public Authority Lake

P.A. Phone 440-974-5774

Date: 4/7/2026

This form must be filled out completely & correctly for us to process your request. Forms not completed correctly will be returned to the sender.

Project Information

Project Name Mentor Municipal Maintenance HVAC Replacement

Site Address 6645 Hopkins Rd

City, OH Mentor , OH

ZIP 44060

County of Project Lake

Prevailing Wage Coordinator Name Kyle Kasky

Address 8500 Civic Center Blvd

City Mentor

ZIP 44060

Phone 440-974-5774

Issuing Authority of Bonds

Estimated Total Overall Project Cost \$85,000

Type of Financing

Type of Construction

This Project is Commercial

Expected Date of Contract Award 05/05/2026

Projected Completion Date 09/01/2026

Project Comments



Prevailing Wage Guide

(Revised January 2024)



PACKET INFORMATION INDEX

This packet of information is provided as a summary of the Prevailing Wage guidelines and responsibilities. The Ohio Revised Code, Chapter 4115 should be referred to for the exact wording of the law. Also included are references and forms which should be helpful in the compliance of the Prevailing Wage Law.

1) The Ohio Department of Commerce-Division of Industrial Compliance, Wage and Hour Administration Investigators and their assigned counties

- a) The Wage and Hour Investigators for the State of Ohio are listed with their contact information.
 - i) If you have questions or need assistance pertaining to Prevailing Wage, you can contact the Investigator in your area.

2) Prevailing Wage Guide for Public Authorities

- a) Notice of change of the Prevailing Wage Threshold Level.
 - i) Prevailing Wage threshold levels are updated every other year.
- b) Outline of the Public Authority's responsibilities for Prevailing Wage.
- c) Public Authority's Compliance Checklist form.
 - i) A form for tracking the progress of a Prevailing Wage project
- d) Request form for Prevailing Wage Rates.
 - i) Prevailing Wage Rates can be obtained on the website www.com.ohio.gov
 - (1) Prevailing Wage Determination Schedule of wages must be attached to and made part of the specifications for the project and must be printed on the bidding blanks where the work is done by contract.
- e) Bid Tabulation form
 - i) A form to be completed and returned to ODOC-DIC-Bureau of Wage and Hour Administration when the contract has been awarded.
- f) Prevailing Wage Bonds form
 - i) Information needed to be kept on file by the Prevailing Wage Coordinator when bonds from the Public Authority are used for a project.
- g) Guideline for the Prevailing Wage Coordinator
 - i) The Prevailing Wage complaint form and instructions can be obtained on the website www.com.ohio.gov
- h) Record of the Certified Payroll Reports Received form
 - i) Helpful form for recording the Certified Payroll Reports and the dates received from the contractors and subcontractors.
- i) Employee Interview form
 - i) Helpful form for the use by the Prevailing Wage Coordinator when making on-site visits.
- j) Employee vs. Independent Contractor
 - i) Helpful questions when determining if a person is an Employee or an Independent Contractor.

3) Prevailing Wage Guide for Contractors

- a) Outline of responsibilities for the Prevailing Wage Contractor
- b) Notification form from the Contractor to the Employee
 - i) The contractor must submit to employees a completed and signed notification form.
 - ii) Some Prevailing Wage Coordinators may require a copy of the completed

- Notification to the Employee form be submitted with the Certified Payroll Reports.
- c) Certified Payroll Report form
 - i) The contractor can use any form/format he chooses if **ALL** the information has been provided.
 - d) Certified Payroll Report form instruction sheet
 - e) Corrected Certified Payroll Report Example
 - f) Affidavit of Compliance form
 - i) No Public Authority shall make final payment unless the **Final Affidavits** have been filed by the contractors and subcontractors.



Ohio Department of Commerce Division of Industrial Compliance Bureau of Wage and Hour Administration Chief, Stephen Clegg	6606 Tussing Road, P.O. Box 4009 Reynoldsburg, OH 43068-9009 P: 614-644-2239 F: 614-728-8639
--	---

INVESTIGATOR CONTACT INFORMATION

Sean Seibert Investigator Supervisor Headquarter County: Lake	Voice: (614) 557-8662 Email: Sean.Seibert@com.ohio.gov
Dave Horvath Investigator Headquarter County: Allen	Voice: (419) 302-1200 Email: David.Horvath@com.ohio.gov
William McCoy Investigator Headquarter County: Franklin	Voice: (614) 633-9356 Email: William.McCoy@com.ohio.gov
Shawn Miles Investigator Headquarter County: Stark	Voice: (614) 496-9076 Email: Shawn.Miles@com.ohio.gov
David Rice Investigator Headquarter County: Montgomery	Voice: (740) 502-0883 Email: Dave.Rice@com.ohio.gov
Kela Thompson Investigator Headquarter County: Franklin	Voice: (614) 633-6818 Email: Kela.Thompson@com.ohio.gov
Stephen Clegg Bureau Chief	Voice: (614) 728-8686 Email: Stephen.Clegg@com.ohio.gov



Prevailing Wage Guide For Public Authorities

PREVAILING WAGE THRESHOLD LEVELS IMPORTANT NOTICE

Before advertising for bids, contracting, or undertaking construction with its own forces, to construct a public improvement, the Public Authority shall have the Ohio Department of Commerce-Division of Industrial Compliance, Bureau of Wage and Hour Administration determine the prevailing rates of wages for workers employed on the public improvement. The wage determination must be included in the project specifications and printed on the bidding blanks where work is done by contract.

“New” construction threshold for Building Construction:	\$250,000
--	------------------

“Reconstruction, enlargement, alteration, repair, remodeling, renovation, or painting” threshold level for Building Construction:	\$75,000
--	-----------------

As of January 1, 2026:

“New” construction that involves roads, streets, alleys, sewers, ditches and other works connected to road or bridge construction threshold level has been adjusted to:	\$101,201
--	------------------

“Reconstruction, enlargement, alteration, repair, remodeling, renovation, or painting” that involves roads, streets, alleys, sewers, ditches and other works connected to road or bridge construction threshold level has been adjusted to:	\$30,320
--	-----------------

- A) Thresholds are to be adjusted biennially by the Director of the Ohio Department of Commerce.
- B) Biennial adjustments to threshold levels are made according to the Building Cost for Skilled Labor Index published by McGraw-Hill’s Engineering News-Record, but may not increase or decrease more than 3% for any year.

If there are questions concerning this notification, please contact:
 Bureau of Wage and Hour Administration
 6606 Tussing Road, PO Box 4009
 Reynoldsburg, Ohio 43068-9009
 Phone: 614-644-2239
 Fax: 614-728-8639
www.com.ohio.gov



Public Authority Responsibilities
ORC Chapter 4115: Wages and Hours on Public Works
(Prevailing Wage Coordinator)

1. Before advertising for bids, contracting, or undertaking construction with its own forces, to construct a public improvement, the public authority shall have the Ohio Department of Commerce, Division of Industrial Compliance, Bureau of Wage and Hour Administration determine the prevailing rates of wages for workers employed on the public improvement. The wage determination must be included in the project specifications and printed on the bidding blanks where work is done by contract.
 - a. "New" construction has a threshold level of **\$250,000**.
 - b. "Reconstruction, enlargement, alteration, repair, remodeling, renovation, or painting" has a threshold level of **\$75,000**.
 - c. "New" construction that involves roads, streets, alleys, sewers, ditches, and other works connected to road or bridge construction has a threshold level of **\$98,974**.
 - d. "Reconstruction, enlargement, alteration, repair, remodeling, renovation, or painting" that involves roads, streets, alleys, sewers, ditches, and other works connected to road or bridge construction has a threshold of **\$29,653**.
 - i. Thresholds are to be adjusted biennially by the Director of Ohio Department of Commerce, Division of Industrial Compliance, Bureau of Wage and Hour Administration.
 - ii. Biennial adjustments to threshold levels are made according to the Price Deflator for Construction Index, United States Department of Commerce, Bureau of the Census, but may not increase or decrease more than 3% for any year.
2. Every contract for public work shall contain a provision that each worker employed by the contractor or subcontractor, or other person about or upon the public work, must be paid the prevailing rate of wages.
3. If contracts are not awarded or construction undertaken within ninety days (90) from the date of the determination of the prevailing wage, there shall be a re-determination of the wage rates before the contract is awarded.

4. Within **seven (7) working days** after the receipt of notification of a change in the prevailing wage rates, the public authority shall notify all affected contractors and subcontractors. If it is determined that a contractor or subcontractor has violated sections 4115.03 to 4115.16 of the Ohio Revised Code because they were not notified as required, **the public authority is liable** for any back wages, fines, damages, court costs and attorney's fees for the period covering the receipt of wage changes, until they give the required notice.
5. No public authority shall award a contract for a public improvement to any contractor or subcontractor whose name appears on the list of debarred contractors. This list is filed with the Secretary of State by the Ohio Department of Commerce-Division of Industrial Compliance & Labor-Bureau of Wage and Hour Administration **The filing of the notice of conviction with the secretary of state constitutes notice to all public authorities.** These contractors are prohibited from working on public improvements for periods ranging from one to three years. The list of debarred contractors can be located on the website www.com.ohio.gov/laws
6. A public authority must designate and appoint **one of its own employees** to serve as the Prevailing Wage Coordinator during the life of the contract for constructing the public improvement. A Prevailing Wage Coordinator must be appointed no later than ten days before the first payment of wages by contractors to employees working on the public improvement.

PUBLIC AUTHORITY'S COMPLIANCE CHECKLIST FOR PREVAILING WAGE

Project:		Number:
Department:		Phone#:
PW Coordinator:		Phone#:
Architect/Engineer:		Phone#:
Contractor:		Phone#:
Contact Person:		Title:
General Contractor:	Prime Contractor:	Construction Mgr:
Date Completed	Compliance Item Description	
1.	Request Prevailing Wage Determination Schedule from ODOC-DIC-Wage & Hour	
2.	Received Prevailing Wage Determination Schedule	
3.	Incorporate Determination Schedule in Specs./Bidding Blanks	
4.	Incorporate notice of Prevailing Wage requirements in Invitation for Bids/Notice to Bidders	
5.	Incorporate Prevailing Wage requirements in Contract	
6.	Submit complete Invitation for Bid to ODOC-DIC-Wage & Hour	
7.	Invitation for Bids	
8.	Bid Opening	
9.	Check Listing of Violators	
10.	Award of Contract. (see note)	
11.	Submit Bid Tabulation/Award to ODOC-DIC-WAGE & HOUR	
12.	Notice to Successful Bidder	
13.	Work Commenced...(see note)	
14.	Appoint Prevailing Wage Coordinator	
15.	Received list of Subcontractors' names, addresses, phone #'s & email's	
16.	Received Payroll Date Schedule	
17.	Received Registered Apprenticeship Agreement Certifications	
18.	Received Deduction Agreements	
19.	Received Payroll Reports with Certification...(see attachment)	
20.	Visited project site	
21.	Received Changes to Determination Schedule	
22.	Notice to Contractors of Determination Schedule change	
23.	Request Final Compliance Affidavit from contractors & subcontractors	
24.	Received Final Affidavits from all contractors & subcontractors	
25.	Certify Final Payment	

Note: If contract is not awarded or construction undertaken within 90 days from the date of establishment of the Prevailing Wage Rates, a re-determination of the Prevailing Wage Rates is required.

INDUSTRIAL DEVELOPMENT BONDS

Bond Projects require the Public Authority to keep the following information on file			
1. Type of Bonds issued:	Amount:		
2. The total cost of the Project:			
3. The other type of financing involved in the project:			
4. Portion of the project being constructed with each type of financing:			
5. Are Prevailing Wage Rates being applied to all construction on the project: ~ Yes ~ No			
6. The name of the political subdivision who issued the bonds:			
7. When were the bonds issued:			
8. For what purpose were the bonds issued:			
9. Who handles the funds once the bonds are sold:			
10. Who is the lending institution that purchased the bonds:			
11. How are the funds to be paid out:			
12. When are the funds to be paid out:			
13. Who is the Bond Council:			
14. Who has been appointed as the Prevailing Wage Coordinator:			
PWC Address:			
City:	OHIO	Zip:	Telephone #:
15. Obtain a copy of the inducement and other official documents for the issuance of bonds.			



Prevailing Wage Coordinator Guidelines

(For more detailed information please refer to Chapter 4115 of the Ohio Revised Code)

1. Attend any pre-bid and/or pre-construction meetings.
 - a. To explain the prevailing wage rate requirements.
 - b. To explain the contractor's responsibilities.
2. Set up and maintain files containing all contractors' and subcontractors' payroll reports, affidavits, and related documents. These files must be available for public inspection.
3. Obtain from each contractor a list of their subcontractors' names, addresses, telephone numbers, and email addresses.
4. Require each contractor and subcontractor to provide their project dates. This will be used to make a time schedule for receiving their certified payrolls.
5. Obtain from each contractor, the name and address of their Bonding\Surety Company.
6. Obtain from out-of-state corporations, the name and address of their Statutory Agent. (This agent must be in the State of Ohio and registered with the Ohio Secretary of State.)
 - a. Records made in connection with the public improvement must not be removed from the State of Ohio for the period of one year following the completion of the project.
7. Supply contractors with any changes in the Prevailing Wage Rates.
8. Within two weeks after the first pay, obtain a certified payroll report from each contractor. A certified report is one that is sworn to and signed by the contractor.
 - a. If the job will exceed four months, all reports after the initial report can be filed once per month. (The initial report must be filed within two weeks.)
 - b. If the job will last less than four months, all reports are to be filed weekly after the initial report.
9. Establish and follow procedures to monitor compliance by contractors and subcontractors.
 - a. Visit project to verify posting requirements and job classifications.
 - b. Review certified payroll reports to ensure they are submitted in a timely fashion and complete with the following information for each employee:
 - i. Name, current address, and their social security number or last 4 when permitted
 - ii. Classification (must be specific for laborers and operators, including level)
 - iii. Hours worked on the project
 - iv. Hourly rate
 - v. Fringe benefits, if applicable
 - vi. Total hours worked for the week (all jobs)
 - vii. Gross wages, all deductions, net pay
 - c. Compare rates and fringes reported to rates in prevailing wage schedule.
10. Upon completion of the project and prior to the final payment, require an affidavit of compliance from each contractor and subcontractor. **No public authority shall make**

final payment to any contractor or subcontractor unless the final affidavits have been filed by the respective contractor and subcontractor. (O.R.C. section 4115.07)

11. Report any non-compliance to Ohio Department of Commerce, Division of Industrial Compliance, Bureau of Wage & Hour Administration. The PW complaint form and instructions can be obtained on the website www.com.ohio.gov.

RECORD OF THE CERTIFIED PAYROLL REPORTS RECEIVED

Project:		Number:
Contractor:		Phone #: Email:
General Contractor:	Prime Contractor:	Subcontractor:
Date work commenced:	Completed:	Final Affidavit:

Payroll	Payroll Date	Date Received		Payroll	Payroll Date	Date Received
1				33		
2				34		
3				35		
4				36		
5				37		
6				38		
7				39		
8				40		
9				41		
10				42		
11				43		
12				44		
13				45		
14				46		
15				47		
16				48		
17				49		
18				50		
19				51		
20				52		
21				53		
22				54		
23				55		
24				56		
25				57		
26				58		
27				59		
28				60		
29				61		
30				62		
31				63		
32				64		



Prevailing Wage Investigation – Employee Interview

Failure to complete this interview form may reduce our ability to recover back wages that might be owed to you.

Project Name:
Address: City: County:

Employee Name: Last 4 Digits of SS#:
Address: City: State: ZIP:
Home Phone Number: Cell/Work Number:
Email:
Best time to be reached:

Another Source of Contact Name: Relationship: Telephone Number:

Contractor's Name: Owner:
Address: City: State: ZIP:
Phone Number: Fax Number:
Email:

Date Hired: Date started on this project:
Approximate number of hours worked on the project:
Method of Recording Hours: Recorded by:
Did you keep a personal record of your hours worked on this project? Do you have paycheck stubs?
Did anyone else keep a personal record? If YES, who:

List your job classification(s):
Journeyman
Apprentice – Level:
Helper

List your specific job duties:	List tools/equipment used:
Hourly Rate of Pay for this Project: \$ _____	Regular Hourly Rate of Pay: \$ _____
Fringe Benefits Paid by Contractor: <input type="checkbox"/> None <input type="checkbox"/> Health Insurance <input type="checkbox"/> Life Insurance <input type="checkbox"/> Pension <input type="checkbox"/> Bonus <input type="checkbox"/> Vacation – Amount: _____ <input type="checkbox"/> Holidays – Amount: _____ <input type="checkbox"/> Apprenticeship Training <input type="checkbox"/> Profit Sharing <input type="checkbox"/> Other (list): _____	
Did you work overtime? <input type="checkbox"/> Yes <input type="checkbox"/> No	Were hours over 40 per week paid at time and half? <input type="checkbox"/> Yes <input type="checkbox"/> No
Circle the day of the week you received your pay: Mon. Tue. Wed. Thurs. Fri. Sat. Sun.	Method of payment: <input type="checkbox"/> Check <input type="checkbox"/> Cash <input type="checkbox"/> Direct Deposit
Please provide a detailed list of the dates, times and hours worked within each classification that may apply to the work performed on a separate sheet.	
Comments (attach additional sheets if necessary):	

<p>Signature and Notary</p> <p>Affiant is further informed that Section 2921.13 of the Ohio Revised Code provides a penalty of a misdemeanor of the first degree and that prosecution will be pursued of those persons who “knowingly swear or affirm the truth of a false statement when ...the statement is sworn or affirmed before a notary public...”</p> <p>Sworn to before me and subscribed by the said:</p> <p>_____ in my presence this _____ day of _____, 20_____.</p> <p>_____</p> <p>Notary Public</p> <p>I hereby certify that this is a true statement to the best of my knowledge and belief.</p> <p>_____</p> <p>Signature _____ Date _____</p>	<p>Return To:</p> <p>Ohio Department of Commerce Bureau of Wage and Hour Administration 6606 Tussing Road, P.O. Box 4009 Reynoldsburg, OH 43068-9009</p> <p>Office: 614-644-2239 Fax: 614-728-8639</p> <p>Email: webmaster@wagehour.com.state.oh.us</p>
Signature of PW Coordinator:	Date:

EMPLOYEE VS. INDEPENDENT CONTRACTOR

EMPLOYEE	↔	<input checked="" type="checkbox"/> YES	Does the employer have the right to control and direct worker?	<input type="checkbox"/> NO	↔	INDEPENDENT CONTRACTOR
EMPLOYEE	↔	<input checked="" type="checkbox"/> YES	Does the worker receive instructions about how and where the work is to be done instead of the employer merely specifying the desired result?	<input type="checkbox"/> NO	↔	INDEPENDENT CONTRACTOR
EMPLOYEE	↔	<input checked="" type="checkbox"/> YES	Is payment based on time spent rather than a set price for the work to be performed?	<input type="checkbox"/> NO	↔	INDEPENDENT CONTRACTOR
EMPLOYEE	↔	<input checked="" type="checkbox"/> YES	Does the worker devote virtually all his working time to the employer rather than offering services to the general public?	<input type="checkbox"/> NO	↔	INDEPENDENT CONTRACTOR
EMPLOYEE	↔	<input type="checkbox"/> NO	Does the worker performing services make their services available to the general public and/or other businesses?	<input checked="" type="checkbox"/> YES	↔	INDEPENDENT CONTRACTOR
EMPLOYEE	↔	<input checked="" type="checkbox"/> YES	Is there a continuing relationship between employer and worker?	<input type="checkbox"/> NO	↔	INDEPENDENT CONTRACTOR
EMPLOYEE	↔	<input checked="" type="checkbox"/> YES	Can the worker be discharged at will?	<input type="checkbox"/> NO	↔	INDEPENDENT CONTRACTOR
EMPLOYEE	↔	<input checked="" type="checkbox"/> YES	Did the employer train the worker for the job?	<input type="checkbox"/> NO	↔	INDEPENDENT CONTRACTOR

EMPLOYEE VS. INDEPENDENT CONTRACTOR-continued

EMPLOYEE	↔	<input checked="" type="checkbox"/> YES	Does the employer have employees performing the same work as the independent contractor?	<input type="checkbox"/> NO	↔	INDEPENDENT CONTRACTOR
EMPLOYEE	↔	<input checked="" type="checkbox"/> YES	Does the worker perform services personally rather than delegating them to others?	<input type="checkbox"/> NO	↔	INDEPENDENT CONTRACTOR
EMPLOYEE	↔	<input checked="" type="checkbox"/> YES	Does the employer set a specific time when the individual services are to be performed?	<input type="checkbox"/> NO	↔	INDEPENDENT CONTRACTOR
EMPLOYEE	↔	<input checked="" type="checkbox"/> YES	Does the employer furnish the tools and materials used by the worker performing services?	<input type="checkbox"/> NO	↔	INDEPENDENT CONTRACTOR
EMPLOYEE	↔	<input checked="" type="checkbox"/> YES	Is the employer assuming all the financial risk, rather than the worker making a significant financial investment in the job and having the opportunity to realize a profit or loss from the work?	<input type="checkbox"/> NO	↔	INDEPENDENT CONTRACTOR
EMPLOYEE	↔	<input type="checkbox"/> NO	Does the individual performing the services publicly advertise these services in for example, the newspaper or yellow pages ?	<input checked="" type="checkbox"/> YES	↔	INDEPENDENT CONTRACTOR
EMPLOYEE	↔	<input type="checkbox"/> NO	Does the individual performing the services have a business license?	<input checked="" type="checkbox"/> YES	↔	INDEPENDENT CONTRACTOR
EMPLOYEE	↔	<input type="checkbox"/> NO	Does the individual performing the services operate d.b.a. or under a tradename?	<input checked="" type="checkbox"/> YES	↔	INDEPENDENT CONTRACTOR



**Department of
Commerce**

Division of Industrial Compliance

com.ohio.gov

Mike DeWine, *Governor* Jon Husted, *Lt. Governor* Sherry Maxfield, *Director*

Prevailing Wage Guide For Contractors



Prevailing Wage Contractor Responsibilities

This is a summary of prevailing wage contractors' responsibilities. For more detailed information please refer to Chapter 4115 of the Ohio Revised Code

General Information

Ohio's prevailing wage laws apply to all public improvements financed in whole or in part by public funds when the total overall project cost is fairly estimated to be more than **\$250,000** for new construction or **\$75,000** for reconstruction, enlargement, alteration, repair, remodeling, renovation, or painting.

Ohio's prevailing wage laws apply to all public improvements financed in whole or in part by public funds when the total overall project cost is fairly estimated to be more than **\$98,974** for new construction that involves roads, streets, alleys, sewers, ditches and other works connected to road or bridge construction or **\$29,653** for reconstruction, enlargement, alteration, repair, remodeling, renovation, or painting of a public improvement that involves roads, streets, alleys, sewers, ditches and other works connected to road or bridge construction.

- a) Thresholds are to be adjusted biennially by the Administrator of Ohio Department of Commerce, Division of Industrial Compliance and Labor, Bureau of Wage and Hour Administration
- b) Biennial adjustments to threshold levels are made according to the Construction Cost Index for Commercial Construction published by McGraw Hill's Engineering News Record.

Penalties for Violation

Violators are to be assessed the wages owed, plus a penalty of 100% of the wages owed.

Intentional Violations

If an intentional violation is determined to have occurred, the contractor is prohibited from contracting directly or indirectly with any public authority for the construction of a public improvement. Intentional violation means "a willful, knowing, or deliberate disregard for any provision" of the prevailing wage law and includes but is not limited to the following actions:

- Intentional failure to submit payroll reports as required or knowingly submitting false or erroneous reports.
- Intentional misclassification of employees for the purpose of reducing wages.
- Intentional misclassification of employees as independent contractors or as apprentices.
- Intentional failure to pay the prevailing wage.
- Intentional failure to comply with the allowable ratio of apprentices to skilled workers as required by the regulations established by Ohio Department of Commerce, Division of Industrial Compliance and Labor, Bureau of Wage and Hour Administration.
- Intentionally employing an officer, of a contractor or subcontractor, that is known to be prohibited from contracting, directly or indirectly, with a public authority.

Responsibilities

1. Pay the prevailing rate of wages as shown in the wage rate schedules issued by the Ohio Department of Commerce, Division of Industrial Compliance and Labor, Bureau of Wage and Hour Administration, for the classification of work being performed.
 - a. Wage rate schedules include all modifications, corrections, escalations, or reductions to wage rates issued for the project.

- b. Overtime must be paid at time and one-half the employee's base hourly rate. Fringe benefits are paid at straight time rate for all hours including overtime.
 - c. Prevailing wages must be paid in full without any deduction for food, lodging, transportation, use of tools, etc., unless the employee has voluntarily consented to these deductions in writing. The public authority and the Director of Ohio Department of Commerce, Division of Industrial Compliance and Labor, Bureau of Wage and Hour Administration - must approve these deductions as fair and reasonable. Consent and approval must be obtained before starting the project.
2. Use of Apprentices and Helpers cannot exceed the ratios permitted in the wage rate schedules.
 - a. Apprentices must be registered with the U.S. Department of Labor Bureau of Apprenticeship and Training.
 - b. Contractors must provide the Prevailing Wage Coordinator a copy of the Apprenticeship Agreement for each apprentice on the project.
3. Keep full and accurate payroll records available for inspection by any authorized representative of the Ohio Department of Commerce, Division of Industrial Compliance, Bureau of Wage and Hour Administration or the contracting public authority, including the Prevailing Wage Coordinator. Records should include but are not limited to:
 - a. Timecards, time sheets, daily work records, etc.
 - b. Payroll ledger\journals and canceled checks\check register.
 - c. Fringe benefit records must include program, address, account number, & canceled checks.
 - d. Records made in connection with the public improvement must not be removed from the State for one year following the completion of the project.
 - e. Out-of-State Corporations must submit to the Ohio Secretary of State the full name and address of their Statutory Agent in Ohio.
4. Prevailing Wage Rate Schedule **must** be posted on the job site where it is accessible to all employees.
5. Prior to submitting the initial payroll report, supply the Prevailing Wage Coordinator with your project dates to schedule reporting of your payrolls.
6. Supply the Prevailing Wage Coordinator a list of all subcontractors including the name, address, and telephone number for each.
 - a. **Contractors are responsible for their subcontractors' compliance with requirements of Chapter 4115 of the Ohio Revised Code.**
7. Before employees start work on the project, supply them with written notification of their job classification, prevailing wage rate, fringe benefit amounts, and the name of the Prevailing Wage Coordinator for the project. A copy of the completed signed notification should be submitted to Prevailing Wage Coordinator.
8. Supply all subcontractors with the Prevailing Wage Rates and changes.
9. Submit certified payrolls within two (2) weeks after the initial pay period. Payrolls must include the following information:
 - a. Employees' names, addresses, and social security numbers.
 - i. Corporate officers/owners/partners and any salaried personnel who do physical work on the project are considered employees. All rate and reporting requirements are applicable to these individuals.

- b. Employees' work classification.
 - i. Be specific about the laborers and/or operators (Group)
 - ii. For all apprentices, show level/year and percent of journeyman's rate
 - c. Hours worked on the project for each employee.
 - i. The number of hours worked in each day and the total number of hours worked each week.
 - d. Hourly rate for each employee.
 - i. The minimum rate paid must be the wage rate for the appropriate classification. The Department's Wage Rate Schedule sets this rate.
 - ii. All overtime worked is to be paid at time and one-half for all hours worked more than forty (40) per week.
 - e. Where fringes are paid into a bona fide plan instead of cash, list each benefit and amount per hour paid to program for each employee.
 - i. When the amount contributed to the fringe benefit plan and the total number of hours worked by the employee on all projects for the year are documented, the hourly amount is calculated by dividing the total contribution of the employer by the total number of hours worked by the employee.
 - ii. When the amount contributed to the fringe benefit is documented but not the total hours worked, the hourly amount is calculated by **dividing the total yearly contribution by 2080**.
 - f. Gross amount earned on all projects during the pay period.
 - g. Total deductions from employee's wages.
 - h. Net amount paid.
10. The reports shall be certified by the contractor, subcontractor, or duly appointed agent stating that the payroll is correct and complete; and that the wage rates shown are not less than those required by the O.R.C. 4115.
11. Provide a Final Affidavit to the Prevailing Wage Coordinator upon the completion of the project.

PREVAILING WAGE NOTIFICATION TO EMPLOYEE

4115.05...the contractor or subcontractor shall furnish each employee **NOT covered by a collective bargaining agreement** written notification of the job classification to which the employee is assigned, the prevailing wage determined to be applicable to that classification, separated into the hourly rate of pay and the fringe payments, and the identity of the prevailing wage coordinator appointed by the public authority. The contractor or subcontractor shall furnish the same notification to each affected employee every time the job classification of the employee is changed.

Project Name:	Job Number:
---------------	-------------

Contractor:

Project Location:

Prevailing Wage Coordinator	Employee
Public Authority:	Name:
Name of PWC:	Street:
Street:	City:
City:	State/Zip:
State/Zip:	Phone:
	Email:
Phone:	Last 4 Digits of SS #:

You will be performing work on this project that falls under these classifications. You will be paid the appropriate rate for the type of work you are performing.

Classification:	Prevailing Wage Rate Total Package:	Minus your fringe benefits *:	Your hourly base rate and overtime:
			/
			/
			/
			/
			/
			/

Hourly fringe benefits paid on your behalf by this company (Yearly amount the **company pays** divided by 2080):

Fringe	Amount	Fringe	Amount
Health Insurance		Vacation	
Life Insurance		Holiday	
Pension		Sick Pay	
Other (Specify)		Training	
Other (Specify)		Total Hourly Fringes *	

Contractor's Signature:	Date:
-------------------------	-------

Employee's Signature:	Date:
-----------------------	-------

INSTRUCTIONS FOR PREPARING CERTIFIED PAYROLL REPORTS

General:

Contractors and subcontractors are required by law to submit certified payroll reports for work on projects covered by Ohio's Prevailing Wage Law. This form meets the reporting requirements established by Ohio Revised Code Chapter 4115. The use of this form is not mandatory; employers may submit their own forms if all of the required information is included. This form may be reproduced, or additional copies obtained from:

**Ohio Department of Commerce
Division of Industrial Compliance
Bureau of Wage and Hour Administration
6606 Tussing Road, P.O. Box 4009
Reynoldsburg, Ohio 43068-9009
614-644-2239
www.com.ohio.gov**

Certified Payroll Heading:

Employer name and address: Company's full name and address...Indicate if the company is a subcontractor.

Subcontractor: Check and list the name of the General Contractor or Prime.

Project: Name and location of the project, including county.

Contracting Public Authority: Name and address of the contracting public authority... (Owner of the project).

Week Ending: Month, day, and year for last day of reporting period.

Payroll #: Indicates first, second, third, etc. payroll filed by the company for the project.

Page indicator: number of pages included in the report.

Project Number: Determined by the public authority...If there is no number leave blank.

Payroll Information by column:

1. Employee Name, Address and Social Security number: This information must be provided for all employees that perform physical labor on the project. The Social Security number is required; the last four digits may be permitted by the public authority. Corporate officers, partners, and salaried employees are considered employees and must be paid the prevailing rate. Individual sole proprietors do not have to pay themselves prevailing rate but must report their hours on the project.
2. Work Class: List classification of work performed by employee. If unsure of work classification, consult the Ohio Department of Commerce-Division of Industrial Compliance & Labor-Bureau of Wage and Hour Administration. Employees working more than one classification should have separate line entries for each classification. Indicate what year/level for Apprentices. Be specific when using laborer and operator classifications; for example, Backhoe Operator or Asphalt Laborer or by "Group".
3. Hours Worked, Day & Date: In the first row of column 3, enter days of the company's pay period for example; M T W TH F S S. The second row is for the date that corresponds with each day for the pay period. In the employee information section, enter the number of hours worked on the prevailing wage project and which day the hours were worked. Separate rows are labeled for (ST) straight time hours and (OT) overtime hours. All hours worked after 40, must be paid at the appropriate overtime rate.
4. Project Total Hours: Total the hours entered for pay period.
5. Base Rate: Enter actual rate per hour paid to the employee. The overtime hourly rate is time and one-half the base rate listed in the prevailing wage schedule plus fringe benefits at straight time rate. The prevailing wage schedule lists the base rate plus fringe benefit amounts. These amounts added together equal the total prevailing wage rate. Employers must pay this total amount in one of three ways.
 - 1) Total rate may be paid in entirety in the base rate to the employee; in which case, the cash designation will be checked for fringe benefits.
 - 2) Total rate may be paid as listed in prevailing wage rate schedule with total fringe amounts paid approved plans.
 - 3) Total rate may be paid with a combination of base rate and fringe payments to approved plans in amounts other than those listed in schedule.
6. Project Gross: Enter total gross wages earned on the project for straight time and overtime. Project hours "X" base rate should equal project gross.
7. Fringes: If fringe benefits are paid in the hourly base rate, indicate this by marking the **Cash** space. If fringe benefits are paid to approved plans as listed in the prevailing wage rate schedule, mark the space **Approved Plans**. If fringe benefits are paid partially in the base rate and partially to approved plans, mark the space **Cash & Approved Plans**. List the hourly amount paid to approved plans for each fringe. If payments are not made on a per hour basis, **calculate the hourly fringe credit by dividing the yearly employer contribution by** the lesser of: hours actually worked in the year (these must be documented) or **2080**. Fringe benefits include: **Employer's share** of health insurance, life insurance, retirement plan, bonus/profit sharing, sick pay, holiday pay, personal leave, vacation, and education/training programs. If unsure of a possible fringe benefit, contact the Ohio Department of Commerce-Division of Industrial Compliance & Labor-Bureau of Wage and Hour Administration.
8. Total Hours All Jobs: Total all hours worked during the pay period including non-prevailing wage jobs.
9. Total Gross All Jobs: Gross amount earned in the pay period for all hours worked.
10. Self-explanatory.
11. Self-explanatory.

Certified Payroll Report

Report for: Check if Subcontractor¹⁾ Contract No: _____ Payroll No: _____
 Company:¹⁾ _____ If Sub, GC/Prime Contractor Name: _____
 Address: _____ Project Name & Location: _____ Week Ending: _____
 City, State, Zip _____ Public Authority (Owner): _____
 Phone No: _____ Sheet:²⁾ _____ of _____

1. Employee Name, Address, & SS# (Last 4 digits if permitted)	2. Work Class ³⁾	3. Prevailing Wage Project Hours Worked - Day & Date							4. Total Hours	5. Base Rate	6. Project Gross	Fringes: <input type="checkbox"/> Cash <input type="checkbox"/> Approved Plans <input type="checkbox"/> Cash & Approved Plans						Weekly Payroll Amount			
												Fringe Rate Your Company Pays Per Hour						8. Total Hrs for all Jobs	9. Total Gross on All Jobs	10. Total Deductions	11. Net Pay on All Jobs
		H&W	Pens	Vac	Hol	Other	Total														
	OT																				
	ST																				
	OT																				
	ST																				
	OT																				
	ST																				
	OT																				
	ST																				
	OT																				
	ST																				

1) By signing below, I certify that: (1) I pay, or supervise the payment of the employees shown above; (2) during the pay period reported on this form, all hours worked on this project have been paid at the appropriate prevailing wage rate for the class of work done; (3) the fringe benefits have been paid as indicated above; (4) no rebates or deductions have been or will be made, directly or indirectly from the total wages earned, other than permissible deductions as defined in ORC Chapter 4115; and (5) apprentices are registered with the U.S. Dept. of Labor, Bureau of Apprenticeship and Training. I understand that the willful falsification of any of the above statements may subject the Contractor or Subcontractor to civil or criminal prosecution.

Type or Print Name and Title _____ Signature _____ Date _____

DO NOT REDO FORM AND CHANGE RATES IF AN ERROR HAS BEEN MADE! SUBMIT A CORRECTED REPORT:

****CORRECTED****

CORRECTED FORMS CAN BE HANDWRITTEN

CERTIFIED PAYROLL REPORT

Total Hours being corrected for this indiv.

Difference in base rate & corrected base rate if applicable.

Employer Name & Address Fill out all other areas of the form as usual.		Name of General / Prime Contractor			Project Name & Location			Contracting Public Authority						
Check if subcontractor <input type="checkbox"/>		Week Ending			Payroll # Correcting from xx to xx Page ___ Of ___			Project Number						
1. Employee Name, Address and Social Security Number	2. Work Class	3. Hours Worked - Day & Date		4. Project Total Hrs	5. Base Rate	6. Project Gross	7. Fringes: Cash <input type="checkbox"/> Approved Plans <input type="checkbox"/> Cash & Approved Plans <input type="checkbox"/>			8. Total Hours All Jobs	9. Total Gross All Jobs	10. Taxes Withheld	11. Other Deducts	12. NET Paid
								H&W	Pens	Vac	App	Other		
Name/Address/SSN	Class	OT												
Name/Address/SSN	Class	ST												
		OT												
		ST												
		OT												
		ST												
		OT												
		ST												
		OT												
		ST												

Put the period that is being corrected, i.e.: Oct 26 to Dec 19, not individual weekly dates.

Difference in fringes & corrected fringes if applicable.

The net paid will be the total of difference paid and the total hours being corrected. Provide Check # in margin.

Date Fill in My signature on this form signifies that I pay, or supervise the payment of the employees shown above. I am certifying: 1) That during the pay period reported on this form, all hours worked on this project have been paid at the appropriate prevailing wage rate for the class of work done. 2) That the fringe benefits have been paid as indicated above. 3) That no rebates or deductions have been or will be made, directly or indirectly from the total wages earned, other than permissible deductions as defined in the Ohio Revised Code Chapter 4115. 4) That apprentices are registered with the U.S. Department of Labor, Bureau of Apprenticeship and Training. The willful falsification of any of the above statements may subject the contractor or subcontractor to civil or criminal prosecution.

Name and Title Complete

Signature Sign

Send cover letter stating what happened, with a signed letter from the employee acknowledging that they were underpaid, received payment, check or transaction number.

**FINAL AFFIDAVIT OF COMPLIANCE
PREVAILING WAGES**

I, _____, _____ do hereby certify
(Name of person signing affidavit) (Title)

that the wages paid to all employees of: _____
(Company name)

for all hours worked on project: _____
(Project name)

_____ (Project location)

During the period from _____ to _____ are in compliance with
(Project Dates)

Prevailing Wage requirements of Chapter 4115 of the Ohio Revised Code. I further certify that no rebates or deductions have been or will be made, directly or indirectly, from any wages paid in connection with this project, other than those provided by law.

(Signature of Officer or Agent)

(Print Name of Officer or Agent)

Sworn to and subscribed in my presence this _____ day of _____, 20_____.

(Notary Public)

The above affidavit must be executed and sworn to by the officer or agent of the contractor or subcontractor who supervises the payment of employees. This affidavit must be submitted to the owner (public authority) before the surety is released or final payment due under the terms of the contract is made.



Instructions for Filing a Minimum Wage Complaint

There is no cost in having a valid complaint investigated by our office. Please be advised, we cannot provide legal advice or act as your attorney. Also, please note, this office is only able to pursue minimum wage for the hours that are found to be unpaid. You also have the option of pursuing your complaint privately or you may wish to contact an attorney. However, you cannot pursue your complaint through both processes at the same time.

After reviewing the guidelines below, if you believe that your situation falls within our investigatory limitations, you may file a complaint with our office.

The Bureau of Wage and Hour Administration investigates complaints involving the following:

- Minimum wage not being paid,
- Overtime not being paid,
- Unauthorized deductions, and
- Last paychecks being held.

We cannot collect wages owed for the any of the following reasons:

- Vacation pay,
- Sick leave,
- Holidays, or
- Other employment benefits promised to you.

In addition, we cannot investigate a complaint if you believe you were improperly terminated or if your employer did not properly withhold taxes, social security, etc.

To file a complaint, please follow these steps:

1. Fill in the form completely using black or blue ink. Please print legibly.
2. Provide copies, NOT originals, of the following: pay stubs, time sheets and any other records that will help prove your claim.
3. Use a separate sheet of paper to explain your situation, if needed.
4. Please have your signature notarized.
5. If you wish to remain anonymous, please indicate that by selecting the correct boxes on the form. Please note, you will remain anonymous until such time that wages are to be paid.
6. Submit the completed complaint form and your records via Mail, Email, or Fax To:

Ohio Department of Commerce
Bureau of Wage and Hour Administration
6606 Tussing Road, P.O. Box 4009
Reynoldsburg, OH 43068-9009

Office: 614-644-2239

Fax: 614-728-8639

Email: webmaster@wagehour.com.state.oh.us

Please note, a complaint will be rejected if it does not contain complete and sufficient information. A complaint may also be rejected depending on your employment status (i.e. an exempt employee).



Minimum Wage Complaint

Current status with this employer: Present employee of business? Former employee of business? Reason for filing complaint: Minimum wage not paid, Overtime not paid, Unpaid wages, Last pay not received, Other (Explain in comments section below) Do not write in this area: Case #, Approved, Rejected, Denied, County, Investigator, Comments:

Incomplete forms will be returned.

Company/Employer Information: Name, Telephone, Address, Email/Website, City, State, Zip, County, Type of Business, Number of Employees, Owner's name, Supervisor's name and title, Is the business still operating?, Has the business filed bankruptcy?, Business is Over / Under \$500,000 per year

Complainant/Employee Information: Name, Telephone, Address, Other telephone numbers where you can be reached: City, State, Zip, County, Email, Yes, I authorize the use of my name, No, I do not authorize the use of my name

Are you over 18 years old? How long did you work there? From / / to / / / What position did you hold?

Wage Payments: Hourly, Salary, Overtime, Weekly, Bi-weekly, Monthly, Were tips received?, Were you employed?, In outside sales?, In a managerial/supervisory position?, By a governmental agency?, In a professional position?, In interstate commerce?, How much are you owed? \$, Time period: From / / to / / / Are any part of these wages for? Bonus, Commission, Vacation/Holiday Pay/Sick Leave, Do you owe your employer for advances, loans, merchandise, etc., If yes, amount owed: \$, Did employer keep time records?, Were you paid in cash?, Did employer keep wage records?, Do you have your own record of hours worked?



Approximate Number of Unpaid Hours:	Were deductions for taxes, etc. withheld? <input type="checkbox"/> Yes <input type="checkbox"/> No If yes, were amounts listed on pay stubs? <input type="checkbox"/> Yes <input type="checkbox"/> No
-------------------------------------	--

Additional comments:

Attach any information to substantiate your claim. Unsubstantiated claims may be returned.

Special Notice	
I _____, on this day _____	<input type="checkbox"/> Yes, I authorize the use of my name
<input type="checkbox"/> Do	<input type="checkbox"/> No, I do not authorize the use of my name
<input type="checkbox"/> Do Not	
assign to the Ohio Department of Commerce all rights, title, and interest to my claim for wages against _____.	
(Employer)	Signature _____ Date _____
In assigning these rights, I am aware that I must submit written notice of any change in my representational status.	

Signature and Notary	Complaints will be returned if not complete and signed
Affiant is further informed that Section 2921.13 of the Ohio Revised Code provides a penalty of a misdemeanor of the first degree and that prosecution will be pursued of those persons who "knowingly swear or affirm the truth of a false statement when... the statement is sworn or affirmed before a notary public..."	I hereby certify that this is a true statement to the best of my knowledge and belief.
Sworn to before me and subscribed by the said:	Signature _____ Date _____
In my presence this _____ day of _____ 20__	Return via Mail, Email, or Fax To:
Notary Public	Ohio Department of Commerce Bureau of Wage and Hour Administration 6606 Tussing Road, P.O. Box 4009 Reynoldsburg, OH 43068-9009 Office: 614-644-2239 Fax: 614-728-8639 Email: webmaster@wagehour.com.state.oh.us

*** Incomplete forms will be returned ***

Prevailing Wage Rate Skilled Crafts

Name of Union: Asbestos Local 207

Type of Rate: Commercial

Change #:
LCN01-2025ib

Craft:
Asbestos Worker

Effective Date:
8/6/2025

Effective Date:
8/6/2025

	BHR		Fringe Benefit Payments						Irrevocable Fund		Total PWR	Overtime Rate
			H&W	Pension	App Tr.	Vac.	Annuity	Other	LECET (*)	MISC (*)		
Classification												
Asbestos Abatement	\$32.50		\$10.95	\$7.25	\$0.75	\$3.75	\$0.00	\$0.05	\$0.00	\$0.00	\$55.25	\$71.50
Apprentice	BHR	Percent										
Trainee	\$22.00	\$67.69	\$10.95	\$1.90	\$0.75	\$1.00	\$0.00	\$0.05	\$0.00	\$0.00	\$36.65	\$47.65

(*)Special Calculation Note :

Other: Drug Testing

Ratio :

3 Journeymen to 1 Trainee

Jurisdiction (* denotes special jurisdictional note) :

Adams, Ashland, Ashtabula*, Athens, Auglaize, Brown, Butler*, Carroll, Champaign, Clark, Clermont, Clinton, Columbiana, Coshocton, Crawford, Cuyahoga, Darke, Delaware, Erie*, Fairfield, Fayette, Franklin, Geauga, Greene, Guernsey, Hamilton, Hardin, Harrison, Highland, Hocking, Holmes, Huron, Knox, Lake, Licking, Logan, Lorain, Madison, Mahoning, Marion, Medina, Miami, Montgomery, Morgan, Morrow, Muskingum, Noble, Perry, Pickaway, Portage, Preble, Richland, Ross, Shelby, Stark, Summit, Trumbull, Tuscarawas, Union, Vinton, Warren*, Wayne

Special Jurisdictional Note :

Ashtabula County: (post offices & townships of Ashtabula, Austinburg, Geneva, Harperfield, Jefferson, Plymouth & Saybrook) (townships of Andover, Cherry Valley, Colbrook, Canneaut, Denmark, Dorset, East Orwell, Hartsgrove, Kingville, Lenox, Monroe, Morgan, New Lyme, North Kingsville, Orwell, Pierpoint, Richmond Rock Creek, Rome, Sheffield, Trumbull, Wayne, Williamsfield & Windsor)

Butler County: (townships of Fairfield, Hanover, Liberty, Milford, Morgan, Oxford, Ripley, Ross, St. Clair, Union & Wayne) (Lemon & Madison)

Erie County: (post offices & townships of Berlin, Berlin Heights, Birmingham, Florence, Huron, Milan, Shinrock & Vermilion)

Warren County: (townships of: Deerfield, Hamilton, Harlan, Salem, Union & Washington) (Clear Creek, Franklin, Mossie, Turtle Creek & Wayne)

Details :

An Abatement Journeyman is anyone who has more than 600 hours in the Asbestos Abatement field.

Asbestos & lead paint abatement including, but not limited to the removal or encapsulation of asbestos & lead paint, all work in conjunction with the preparation of the removal of same & all work in conjunction with the clean up after said removal. The removal of all insulation materials, whether they contain asbestos or not, from mechanical systems (pipes, boilers, ducts, flues, breaching, etc.) is recognized as being the exclusive work of the Asbestos Abatement Workers.

On all mechanical systems (pipes, boilers, ducts, flues, breaching, etc.) that are going to be demolished, the removal of all insulating materials whether they contain asbestos or not shall be the exclusive work of the Laborers.

Prevailing Wage Rate Skilled Crafts

Name of Union: Asbestos Local 3 Heat & Frost Insulators

Type of Rate: Commercial

Change #:
LCN01-2025ib

Craft:
Asbestos Worker

Effective Date:
8/20/2025

Effective Date:
8/20/2025

	BHR		Fringe Benefit Payments					Irrevocable Fund		Total PWR	Overtime Rate	
			H&W	Pension	App Tr.	Vac.	Annuity	Other	LECET (*)			MISC (*)
Classification												
Asbestos Insulation Worker	\$45.63		\$16.60	\$10.75	\$0.00	\$0.00	\$0.00	\$0.00	\$0.00	\$0.00	\$72.98	\$95.80
Fire Stop Specialist	\$45.63		\$16.60	\$10.75	\$0.00	\$0.00	\$0.00	\$0.00	\$0.00	\$0.00	\$72.98	\$95.80
Fire Stop Technician	\$37.28		\$16.60	\$4.50	\$0.00	\$0.00	\$0.00	\$0.00	\$0.00	\$0.00	\$58.38	\$77.02
Apprentice	BHR	Percent										
1st year	\$25.69	\$56.30	\$16.60	\$1.50	\$0.00	\$0.00	\$0.00	\$0.00	\$0.00	\$0.00	\$43.79	\$56.64
2nd year	\$28.34	\$62.10	\$16.60	\$2.50	\$0.00	\$0.00	\$0.00	\$0.00	\$0.00	\$0.00	\$47.44	\$61.61
3rd year	\$31.00	\$67.93	\$16.60	\$3.50	\$0.00	\$0.00	\$0.00	\$0.00	\$0.00	\$0.00	\$51.10	\$66.60
4th year	\$37.28	\$81.70	\$16.60	\$4.50	\$0.00	\$0.00	\$0.00	\$0.00	\$0.00	\$0.00	\$58.38	\$77.02

(*)Special Calculation Note :

Ratio :

3 Journeymen to 1 Apprentice

Jurisdiction (* denotes special jurisdictional note) :

Ashtabula*, Cuyahoga, Erie*, Geauga, Huron, Lake, Lorain

Special Jurisdictional Note :

Ashtabula: the townships of Ashtabula, Austinburg, Geneva, Jefferson, Plymouth & Saybrook
Erie: to Sandusky limits

Details :

Mechanics & apprentices engaged in the manufacture, fabrication, assembling, molding, handling, erection, spraying, pouring, mixing, hanging, clean-up, preparation, application, adjusting, alteration, repairing, dismantling, reconditioning, testing & maintenance of Heat & Frost Insulation such as Magnesia, Asbestos, Hair Felt, Wool Felt, Cork, Mineral Wool, Infusorial Earth, Mercerized Silk, Flax, Fiber, Fire Felt, Asbestos Paper, Asbestos Curtain, Asbestos Millboard, Fiberglass, Foam glass, Styrofoam, Polyurethane, fire stopping, smoke stopping, all recyclable material, soundproofing, all penetrations, any flexible or rigid fireproofing, all jacketing systems including metal, lead, and PVC or other material.

Prevailing Wage Rate Skilled Crafts

Name of Union: Boilermaker Local 744

Type of Rate: Commercial

Change #:
LCN01-2024ib

Craft:
Boilermaker

Effective Date:
6/5/2024

Effective Date:
6/5/2024

	BHR		Fringe Benefit Payments					Irrevocable Fund		Total PWR	Overtime Rate	
			H&W	Pension	App Tr.	Vac.	Annuity	Other	LECET (*)			MISC (*)
Classification												
Boilermaker	\$42.70		\$7.07	\$17.74	\$0.78	\$0.00	\$9.56	\$0.34	\$0.00	\$0.00	\$78.19	\$99.54
Apprentice	BHR	Percent										
1st 6 months	\$29.89	\$70.00	\$7.07	\$17.74	\$0.78	\$0.00	\$9.56	\$0.34	\$0.00	\$0.00	\$65.38	\$80.33
2nd 6 months	\$30.96	\$72.50	\$7.07	\$17.74	\$0.78	\$0.00	\$9.56	\$0.34	\$0.00	\$0.00	\$66.45	\$81.93
3rd 6 months	\$32.03	\$75.00	\$7.07	\$17.74	\$0.78	\$0.00	\$9.56	\$0.34	\$0.00	\$0.00	\$67.52	\$83.53
4th 6 months	\$33.09	\$77.50	\$7.07	\$17.74	\$0.78	\$0.00	\$9.56	\$0.34	\$0.00	\$0.00	\$68.58	\$85.13
5th 6 months	\$34.16	\$80.00	\$7.07	\$17.74	\$0.78	\$0.00	\$9.56	\$0.34	\$0.00	\$0.00	\$69.65	\$86.73
6th 6 months	\$36.30	\$85.00	\$7.07	\$17.74	\$0.78	\$0.00	\$9.56	\$0.34	\$0.00	\$0.00	\$71.79	\$89.93
7th 6 months	\$38.43	\$90.00	\$7.07	\$17.74	\$0.78	\$0.00	\$9.56	\$0.34	\$0.00	\$0.00	\$73.92	\$93.14
8th 6 months	\$40.57	\$95.00	\$7.07	\$17.74	\$0.78	\$0.00	\$9.56	\$0.34	\$0.00	\$0.00	\$76.06	\$96.34

(*)Special Calculation Note :

Other: Training Fund

Ratio :

3 Journeymen to 1 Apprentice

Jurisdiction (* denotes special jurisdictional note) :

Ashtabula, Carroll, Coshocton, Cuyahoga, Geauga, Harrison, Holmes, Lake, Lorain, Mahoning, Medina, Portage, Stark, Summit, Trumbull, Tuscarawas, Wayne

Special Jurisdictional Note :

Details :

Prevailing Wage Rate Skilled Crafts

Name of Union: Bricklayer Local 23 (Cleveland Marble Finisher)

Type of Rate: Commercial

Change #:
LCN01-2024ib

Craft:
Bricklayer

Effective Date:
5/1/2024

Effective Date:
5/1/2024

	BHR		Fringe Benefit Payments					Irrevocable Fund		Total PWR	Overtime Rate	
			H&W	Pension	App Tr.	Vac.	Annuity	Other	LECET (*)			MISC (*)
Classification												
Bricklayer Tile Marble Finisher	\$30.52		\$11.40	\$5.15	\$0.66	\$0.00	\$0.00	\$0.00	\$0.00	\$0.00	\$47.73	\$62.99
Apprentice	BHR	Percent										
1st 6 months	\$18.31	\$60.00	\$11.40	\$0.00	\$0.00	\$0.00	\$0.00	\$0.00	\$0.00	\$0.00	\$29.71	\$38.87
2nd 6 months	\$21.36	\$70.00	\$11.40	\$5.15	\$0.66	\$0.00	\$0.00	\$0.00	\$0.00	\$0.00	\$38.57	\$49.26
3rd 6 months	\$22.89	\$75.00	\$11.40	\$5.15	\$0.66	\$0.00	\$0.00	\$0.00	\$0.00	\$0.00	\$40.10	\$51.55
4th 6 months	\$24.42	\$80.00	\$11.40	\$5.15	\$0.66	\$0.00	\$0.00	\$0.00	\$0.00	\$0.00	\$41.63	\$53.83
5th 6 months	\$25.94	\$85.00	\$11.40	\$5.15	\$0.66	\$0.00	\$0.00	\$0.00	\$0.00	\$0.00	\$43.15	\$56.12
6th 6 months	\$27.47	\$90.00	\$11.40	\$5.15	\$0.66	\$0.00	\$0.00	\$0.00	\$0.00	\$0.00	\$44.68	\$58.41

(*)Special Calculation Note :

Classification title contains "Bricklayer" because contract originates within the Bricklayer Local. Note that the classification description is clarified after the local union number at the top of the page.

Ratio :

1-2 Journeymen to 1 Apprentice 3- 4 Journeymen to 2 Apprentice 5-6 Journeymen to 3 Apprentice 7-8 Journeymen to 4 Apprentice

Jurisdiction (* denotes special jurisdictional note) :

Ashtabula, Cuyahoga, Geauga, Lake, Lorain, Medina, Portage, Summit

Special Jurisdictional Note :

Details :

Tile Finishers:do all the cleaning, acid washing,grouting,by any methods or means. Also unpacking of all tiles,opening of all mastic containers,mixing of all mortar,thin-set and epoxy materials,also the distribution of it. They shall handle and distribute all materials such as sand,cement,lime,tile,all types of tile panels,prefabricated tile units, plastic materials and protective covering of all tile.Clean up and removal of always used in connection of said work. Terrazzo Finishers:Assisting in grinding, and handling of material whether by hand or wheel barrow, or power buggies, including sand Portland cement, resinous cement and admixtures, aggregates of marble, stone or other compositions, bonding adhesives, sealers, waxes, and coatings used for Terrazzo Mosaic work, preparing, mixing by hand or machine, and distributing (spreading) all kinds of underbed or underlayment necessary and all scratch coat used for terrazzo and mosaic work. Also the rubbing, grinding, cleaning, sealing and polishing same either by hand or machine. will assist in the installation of the sand bed, tar paper, wire lath, divider strips, and rolling procedures and acid etching of all concrete floors that require it before installation. Shall handle all materials and assist in the installation of all types of terrazzo floors whether conventional or thin-set variety. Marble Finishers>Loading and unloading handling and distributing of marble materials including the mixing of all materials used for the installation of marble, such as cement underbeds for the floors, thin-set or epoxies including but not limited to plastic materials. Clean up and removal of all waster material of said work. Cleaning and grouting of all marble and slate, and all polishing of marble and slate floors.

Prevailing Wage Rate Skilled Crafts

Name of Union: Bricklayer Local 23 (Cleveland Marble Mason)

Type of Rate: Commercial

Change #:
LCN01-2024ib

Craft:
Bricklayer

Effective Date:
5/1/2024

Effective Date:
5/1/2024

	BHR		Fringe Benefit Payments					Irrevocable Fund		Total PWR	Overtime Rate	
			H&W	Pension	App Tr.	Vac.	Annuity	Other	LECET (*)			MISC (*)
Classification												
Bricklayer Horizontal Marble Mason	\$27.16		\$11.40	\$9.45	\$0.67	\$0.00	\$0.00	\$0.00	\$0.00	\$0.00	\$48.68	\$62.26
Masonry Maintenance Specialist	\$13.58		\$0.00	\$0.00	\$0.00	\$0.00	\$0.00	\$0.00	\$0.00	\$0.00	\$13.58	\$20.37
Apprentice	BHR	Percent										
1st 6 Months	\$16.30	\$60.00	\$11.40	\$0.00	\$0.00	\$0.00	\$0.00	\$0.00	\$0.00	\$0.00	\$27.70	\$35.84
2nd 6 Months	\$17.65	\$65.00	\$11.40	\$1.60	\$0.67	\$0.00	\$0.00	\$0.00	\$0.00	\$0.00	\$31.32	\$40.15
3rd 6 Months	\$19.01	\$70.00	\$11.40	\$9.45	\$0.67	\$0.00	\$0.00	\$0.00	\$0.00	\$0.00	\$40.53	\$50.04
4th 6 Months	\$20.37	\$75.00	\$11.40	\$9.45	\$0.67	\$0.00	\$0.00	\$0.00	\$0.00	\$0.00	\$41.89	\$52.08
5th 6 Months	\$21.73	\$80.00	\$11.40	\$9.45	\$0.67	\$0.00	\$0.00	\$0.00	\$0.00	\$0.00	\$43.25	\$54.11
6th 6 Months	\$23.09	\$85.02	\$11.40	\$9.45	\$0.67	\$0.00	\$0.00	\$0.00	\$0.00	\$0.00	\$44.61	\$56.16
MASON TRAINEES	\$	\$	\$	\$	\$	\$	\$	\$	\$	\$	\$	\$
1st 90 Days	\$12.22	\$45.00	\$0.00	\$0.00	\$0.00	\$0.00	\$0.00	\$0.00	\$0.00	\$0.00	\$12.22	\$18.33
1st year after 90 Days	\$12.22	\$45.00	\$11.40	\$0.00	\$0.00	\$0.00	\$0.00	\$0.00	\$0.00	\$0.00	\$23.62	\$29.73
2nd Year	\$13.58	\$50.00	\$11.40	\$0.00	\$0.00	\$0.00	\$0.00	\$0.00	\$0.00	\$0.00	\$24.98	\$31.77

(*)Special Calculation Note :

No special calculations for this skilled craft wage rate are required at this time. Classification title contains "Bricklayer" because contract originates within the Bricklayer Local.

Ratio :

1-2 Journeyman to 1 Apprentice 3-4 Journeyman to 2 Apprentices 5-6 Journeyman to 2 Apprentices 6-10 Journeyman to 3 Apprentices 1 Apprentice permits 1 Mason Trainee 2 Apprentice permits 1 Mason Trainee 3 Apprentice permits 2 Mason Trainee 4 Apprentice permits 2 Mason Trainee

Jurisdiction (* denotes special jurisdictional note) :

Ashtabula, Cuyahoga, Geauga, Lake, Lorain, Medina, Portage, Summit

Special Jurisdictional Note :

Details :

In the mutual interest of both Employer and Union and to promote the masonry industry, it is agreed that the Employer may work with the Union and the Local Educational Partners in the jurisdiction of this agreement to employ School to work students provided that no conflicts exist with any Federal or State Laws. Employer must be party to a bonified Apprenticeship and Training program registered with the State of Ohio (OSAC). It is further agreed by both parties that the wages for the Masonry Maintenance Specialist shall be forty-five percent (45%) of the journeyman rate with no fringe benefits or as specified by the Local Educational Partner in the jurisdiction of the agreement.

Prevailing Wage Rate Skilled Crafts

Name of Union: Bricklayer Local 23 (Cleveland Marble, Terrazzo, & Mosaic)

Type of Rate: Commercial

Change #:
LCN01-2024ib

Craft:
Bricklayer

Effective Date:
5/1/2024

Effective Date:
5/1/2024

	BHR		Fringe Benefit Payments					Irrevocable Fund		Total PWR	Overtime Rate	
			H&W	Pension	App Tr.	Vac.	Annuity	Other	LECET (*)			MISC (*)
Classification												
Bricklayer Marble, Terrazzo, Mosaic	\$37.96		\$11.40	\$9.45	\$0.78	\$0.00	\$0.00	\$0.00	\$0.00	\$0.00	\$59.59	\$78.57
Swing Scaffold Workers	\$38.96		\$11.40	\$9.45	\$0.78	\$0.00	\$0.00	\$0.00	\$0.00	\$0.00	\$60.59	\$80.07
Stack	\$38.46		\$11.40	\$9.45	\$0.78	\$0.00	\$0.00	\$0.00	\$0.00	\$0.00	\$60.09	\$79.32
Masonary Maintenance	\$17.08		\$0.00	\$0.00	\$0.00	\$0.00	\$0.00	\$0.00	\$0.00	\$0.00	\$17.08	\$25.62
Apprentice	BHR	Percent										
1st 6 months	\$22.78	\$60.00	\$11.40	\$0.00	\$0.00	\$0.00	\$0.00	\$0.00	\$0.00	\$0.00	\$34.18	\$45.56
2nd 6 months	\$24.67	\$65.00	\$11.40	\$9.45	\$0.78	\$0.00	\$0.00	\$0.00	\$0.00	\$0.00	\$46.30	\$58.64
3rd 6 months	\$26.57	\$70.00	\$11.40	\$9.45	\$0.78	\$0.00	\$0.00	\$0.00	\$0.00	\$0.00	\$48.20	\$61.49
4th 6 months	\$28.47	\$75.00	\$11.40	\$9.45	\$0.78	\$0.00	\$0.00	\$0.00	\$0.00	\$0.00	\$50.10	\$64.34
5th 6 months	\$30.37	\$80.00	\$11.40	\$9.45	\$0.78	\$0.00	\$0.00	\$0.00	\$0.00	\$0.00	\$52.00	\$67.18
6th 6 months	\$32.27	\$85.02	\$11.40	\$9.45	\$0.78	\$0.00	\$0.00	\$0.00	\$0.00	\$0.00	\$53.90	\$70.04
7th 6 months	\$34.16	\$90.00	\$11.40	\$9.45	\$0.78	\$0.00	\$0.00	\$0.00	\$0.00	\$0.00	\$55.79	\$72.88
8th 6 months	\$36.06	\$95.00	\$11.40	\$9.45	\$0.78	\$0.00	\$0.00	\$0.00	\$0.00	\$0.00	\$57.69	\$75.72
MASON TRAINEES 1st 90 Days	\$17.08	\$45.00	\$0.00	\$0.00	\$0.00	\$0.00	\$0.00	\$0.00	\$0.00	\$0.00	\$17.08	\$25.62
1st Year after 90 Days	\$17.08	\$45.00	\$11.40	\$0.00	\$0.00	\$0.00	\$0.00	\$0.00	\$0.00	\$0.00	\$28.48	\$37.02
2nd Year	\$18.98	\$50.00	\$11.40	\$0.00	\$0.00	\$0.00	\$0.00	\$0.00	\$0.00	\$0.00	\$30.38	\$39.87

(*)Special Calculation Note :

Classification title contains "Bricklayer" because contract originates within the Bricklayer Local.

Ratio :

1-2 Journeyman to 1 Apprentice 3-4 Journeyman to 2 Apprentices 5-6 Journeyman to 3 Apprentices 7-10
Journeyman to 4 Apprentices 1 Apprentice permits 1 Mason Trainee 2 Apprentice permits 1 Mason Trainee 3
Apprentice permits 2 Mason Trainee 4 Apprentice permits 2 Mason Trainee

Jurisdiction (* denotes special jurisdictional note) :

Ashtabula, Geauga, Lake, Portage, Summit

Special Jurisdictional Note :

Details :

In the mutual interest of both Employer and Union and to promote the masonry industry, it is agreed that the Employer may work with the Union and the Local Educational Partners in the jurisdiction of this agreement to employ School to work students provided that no conflicts exist with any Federal or State Laws. Employer must be party to a bonified Apprenticeship and Training program registered with the State of Ohio (OSAC). It is further agreed by both parties that the wages for the Masonry Maintenance Specialist shall be forty-five percent (45%) of the journeyman rate with no fringe benefits or as specified by the Local Educational Partner in the jurisdiction of the agreement.

Prevailing Wage Rate Skilled Crafts

Name of Union: Bricklayer Local 23 (Cleveland Terrazzo Finisher)

Type of Rate: Commercial

Change #:
LCN01-2024ib

Craft:
Bricklayer

Effective Date:
5/1/2024

Effective Date:
5/1/2024

	BHR		Fringe Benefit Payments					Irrevocable Fund		Total PWR	Overtime Rate	
			H&W	Pension	App Tr.	Vac.	Annuity	Other	LECET (*)			MISC (*)
Classification												
Bricklayer Terrazzo Finisher	\$30.52		\$11.40	\$5.15	\$0.66	\$0.00	\$0.00	\$0.00	\$0.00	\$0.00	\$47.73	\$62.99
Apprentice	BHR	Percent										
1st 6 months	\$18.31	\$60.00	\$11.40	\$0.00	\$0.00	\$0.00	\$0.00	\$0.00	\$0.00	\$0.00	\$29.71	\$38.87
2nd 6 months	\$21.36	\$70.00	\$11.40	\$5.15	\$0.66	\$0.00	\$0.00	\$0.00	\$0.00	\$0.00	\$38.57	\$49.26
3rd 6 months	\$22.89	\$75.00	\$11.40	\$5.15	\$0.66	\$0.00	\$0.00	\$0.00	\$0.00	\$0.00	\$40.10	\$51.55
4th 6 months	\$24.42	\$80.00	\$11.40	\$5.15	\$0.66	\$0.00	\$0.00	\$0.00	\$0.00	\$0.00	\$41.63	\$53.83
5th 6 months	\$25.94	\$85.00	\$11.40	\$5.15	\$0.66	\$0.00	\$0.00	\$0.00	\$0.00	\$0.00	\$43.15	\$56.12
6th 6 months	\$27.47	\$90.00	\$11.40	\$5.15	\$0.66	\$0.00	\$0.00	\$0.00	\$0.00	\$0.00	\$44.68	\$58.41

(*)Special Calculation Note :

Classification title contains "Bricklayer" because contract originates within the Bricklayer Local. Note that the classification description is clarified after the local union number at the top of the page.

Ratio :

1-2 Journeymen to 1 Apprentice 3- 4 Journeymen to 2 Apprentices 5- 6 Journeymen to 3 Apprentices 7- 8 Journeymen to 4 Apprentices

Jurisdiction (* denotes special jurisdictional note) :

Ashtabula, Cuyahoga, Geauga, Lake, Lorain, Medina, Portage, Summit

Special Jurisdictional Note :

Details :

Tile Finishers:do all the cleaning, acid washing,grouting,by any methods or means. Also unpacking of all tiles,opening of all mastic containers,mixing of all mortar,thin-set and epoxy materials,also the distribution of it. They shall handle and distribute all materials such as sand,cement,lime,tile,all types of tile panels,prefabricated tile units, plastic materials and protective covering of all tile.Clean up and removal of always used in connection of said work. Terrazzo Finishers:Assisting in grinding, and handling of material whether by hand or wheel barrow, or power buggies, including sand Portland cement, resinous cement and admixtures, aggregates of marble, stone or other compositions, bonding adhesives, sealers, waxes, and coatings used for Terrazzo Mosaic work, preparing, mixing by hand or machine, and distributing (spreading) all kinds of underbed or underlayment necessary and all scratch coat used for terrazzo and mosaic work. Also the rubbing, grinding, cleaning, sealing and polishing same either by hand or machine. will assist in the installation of the sand bed, tar paper, wire lath, divider strips, and rolling procedures and acid etching of all concrete floors that require it before installation. Shall handle all materials and assist in the installation of all types of terrazzo floors whether conventional or thin-set variety. Marble Finishers>Loading and unloading handling and distributing of marble materials including the mixing of all materials used for the installation of marble, such as cement underbeds for the floors, thin-set or epoxies including but not limited to plastic materials. Clean up and removal of all waster material of said work. Cleaning and grouting of all marble and slate, and all polishing of marble and slate floors.

Prevailing Wage Rate Skilled Crafts

Name of Union: Bricklayer Local 23 (Cleveland Zone 1 Tile Finisher)

Type of Rate: Commercial

Change #:
LCN01-2025ib

Craft:
Bricklayer

Effective Date:
5/7/2025

Effective Date:
5/7/2025

	BHR		Fringe Benefit Payments					Irrevocable Fund		Total PWR	Overtime Rate	
			H&W	Pension	App Tr.	Vac.	Annuity	Other	LECET (*)			MISC (*)
Classification												
Bricklayer Tile Finisher	\$32.41		\$9.70	\$1.35	\$0.69	\$0.00	\$5.00	\$0.00	\$0.00	\$0.00	\$49.15	\$65.36
Apprentice	BHR	Percent										
1st 6 months	\$19.45	\$60.00	\$9.70	\$0.00	\$0.00	\$0.00	\$0.00	\$0.00	\$0.00	\$0.00	\$29.15	\$38.87
2nd 6 months	\$22.69	\$70.00	\$9.70	\$1.35	\$0.69	\$0.00	\$5.00	\$0.00	\$0.00	\$0.00	\$39.43	\$50.77
3rd 6 months	\$24.31	\$75.00	\$9.70	\$1.35	\$0.69	\$0.00	\$5.00	\$0.00	\$0.00	\$0.00	\$41.05	\$53.20
4th 6 months	\$25.93	\$80.00	\$9.70	\$1.35	\$0.69	\$0.00	\$5.00	\$0.00	\$0.00	\$0.00	\$42.67	\$55.63
5th 6 months	\$27.55	\$85.02	\$9.70	\$1.35	\$0.69	\$0.00	\$5.00	\$0.00	\$0.00	\$0.00	\$44.29	\$58.07
6th 6 months	\$29.17	\$90.00	\$9.70	\$1.35	\$0.69	\$0.00	\$5.00	\$0.00	\$0.00	\$0.00	\$45.91	\$60.49

(*)Special Calculation Note :

Ratio :

1-4 Journeymen to 1 Apprentice 5-10 Journeymen to 2 Apprentice 11-16 Journeymen to 3 Apprentice

Jurisdiction (* denotes special jurisdictional note) :

Ashtabula, Cuyahoga, Geauga, Lake, Lorain, Medina

Special Jurisdictional Note :

Details :

Tile Finishers:do all the cleaning, acid washing,grouting,by any methods or means. Also unpacking of all tiles,opening of all mastic containers,mixing of all mortar,thin-set and epoxy materials,also the distribution of it. They shall handle and distribute all materials such as sand,cement,lime,tile,all types of tile panels,prefabricated tile units, plastic materials and protective covering of all tile.Clean up and removal of always used in connection of said work.

Prevailing Wage Rate Skilled Crafts

Name of Union: Bricklayer Local 23 (Cleveland Zone 1 Tile Layer)

Type of Rate: Commercial

Change #:
LCN01-2025ib

Craft:
Bricklayer

Effective Date:
5/7/2025

Effective Date:
5/7/2025

	BHR		Fringe Benefit Payments						Irrevocable Fund		Total PWR	Overtime Rate
			H&W	Pension	App Tr.	Vac.	Annuity	Other	LECET (*)	MISC (*)		
Classification												
Bricklayer Tile Layer	\$37.11		\$9.80	\$2.43	\$0.77	\$0.00	\$7.10	\$0.00	\$0.00	\$0.00	\$57.21	\$75.77
Apprentice	BHR	Percent										
1st 30 days	\$22.27	\$60.00	\$0.00	\$0.00	\$0.00	\$0.00	\$0.00	\$0.00	\$0.00	\$0.00	\$22.27	\$33.40
1st 6 months	\$22.27	\$60.00	\$9.80	\$0.00	\$0.00	\$0.00	\$0.00	\$0.00	\$0.00	\$0.00	\$32.07	\$43.20
2nd 6 months	\$24.12	\$65.00	\$9.80	\$2.43	\$0.77	\$0.00	\$7.10	\$0.00	\$0.00	\$0.00	\$44.22	\$56.28
3rd 6 months	\$25.98	\$70.00	\$9.80	\$2.43	\$0.77	\$0.00	\$7.10	\$0.00	\$0.00	\$0.00	\$46.08	\$59.07
4th 6 months	\$27.83	\$75.00	\$9.80	\$2.43	\$0.77	\$0.00	\$7.10	\$0.00	\$0.00	\$0.00	\$47.93	\$61.85
5th 6 months	\$29.69	\$80.00	\$9.80	\$2.43	\$0.77	\$0.00	\$7.10	\$0.00	\$0.00	\$0.00	\$49.79	\$64.63
6th 6 months	\$31.54	\$85.00	\$9.80	\$2.43	\$0.77	\$0.00	\$7.10	\$0.00	\$0.00	\$0.00	\$51.64	\$67.42
7th 6 months	\$33.40	\$90.00	\$9.80	\$2.43	\$0.77	\$0.00	\$7.10	\$0.00	\$0.00	\$0.00	\$53.50	\$70.20
8th 6 months	\$35.25	\$95.00	\$9.80	\$2.43	\$0.77	\$0.00	\$7.10	\$0.00	\$0.00	\$0.00	\$55.35	\$72.98

(*)Special Calculation Note :

Classification title contains "Bricklayer" because contract originates within the Bricklayer Local. Note that the classification description is clarified after the local union number at the top of the page.

Ratio :

1-4 Journeymen to 1 Apprentice 5-10 Journeymen to 2 Apprentice 11-16 Journeymen to 3 Apprentice

Jurisdiction (* denotes special jurisdictional note) :

Ashtabula, Cuyahoga, Geauga, Lake, Lorain, Medina

Special Jurisdictional Note :

Details :

Prevailing Wage Rate Skilled Crafts

Name of Union: Bricklayer Local 23 (Mentor)

Type of Rate: Commercial

Change #:
LCN01-2025ib

Craft:
Bricklayer

Effective Date:
5/7/2025

Effective Date:
5/7/2025

	BHR		Fringe Benefit Payments					Irrevocable Fund		Total PWR	Overtime Rate
			H&W	Pension	App Tr.	Vac.	Annuity	Other	LECET (*)		
Classification											
Bricklayer	\$38.46		\$10.00	\$8.59	\$0.81	\$0.00	\$2.50	\$0.00	\$0.00	\$60.36	\$79.59
Cement & Stone Masons	\$38.46		\$10.00	\$8.59	\$0.81	\$0.00	\$2.50	\$0.00	\$0.00	\$60.36	\$79.59
Pointer Caulker Cleaner	\$38.46		\$10.00	\$8.59	\$0.81	\$0.00	\$2.50	\$0.00	\$0.00	\$60.36	\$79.59
Plasterers	\$38.46		\$10.00	\$8.59	\$0.81	\$0.00	\$2.50	\$0.00	\$0.00	\$60.36	\$79.59
Mason Trainees	\$		\$	\$	\$	\$	\$	\$	\$	\$	\$
1-90 Days	\$17.31		\$0.00	\$0.00	\$0.00	\$0.00	\$0.00	\$0.00	\$0.00	\$17.31	\$25.97
91-365 Days	\$17.31		\$10.00	\$0.00	\$0.00	\$0.00	\$0.00	\$0.00	\$0.00	\$27.31	\$35.97
366 plus days	\$19.23		\$10.00	\$0.00	\$0.00	\$0.00	\$0.00	\$0.00	\$0.00	\$29.23	\$38.85
Apprentice	BHR	Percent									
1st 6 months	\$23.08	\$60.00	\$10.00	\$2.30	\$0.81	\$0.00	\$2.50	\$0.00	\$0.00	\$38.69	\$50.22
2nd 6 months	\$25.00	\$65.00	\$10.00	\$2.30	\$0.81	\$0.00	\$2.50	\$0.00	\$0.00	\$40.61	\$53.11
3rd 6 months	\$26.92	\$70.00	\$10.00	\$2.30	\$0.81	\$0.00	\$2.50	\$0.00	\$0.00	\$42.53	\$55.99
4th 6 months	\$28.85	\$75.00	\$10.00	\$2.30	\$0.81	\$0.00	\$2.50	\$0.00	\$0.00	\$44.46	\$58.88
5th 6 months	\$30.77	\$80.00	\$10.00	\$2.30	\$0.81	\$0.00	\$2.50	\$0.00	\$0.00	\$46.38	\$61.76
6th 6 months	\$32.69	\$85.00	\$10.00	\$2.30	\$0.81	\$0.00	\$2.50	\$0.00	\$0.00	\$48.30	\$64.65
7th 6 months	\$34.61	\$90.00	\$10.00	\$2.30	\$0.81	\$0.00	\$2.50	\$0.00	\$0.00	\$50.22	\$67.53
8th 6 months	\$36.54	\$95.00	\$10.00	\$2.30	\$0.81	\$0.00	\$2.50	\$0.00	\$0.00	\$52.15	\$70.42

(*)Special Calculation Note :

Apprentices must be employed prior to hiring Mason Finisher(s).

Ratio :

1-3 Journeymen to 1 Apprentice 4-6 Journeymen to 2 Apprentice 7-9 Journeymen to 3 Apprentice 10-12 Journeymen to 4 Apprentice 1 Apprentice permits 1 Mason Trainee 2 Apprentice permits 1 Mason Trainee 3 Apprentice permits 2 Mason Trainee 4 Apprentice permits 2 Mason Trainee

Jurisdiction (* denotes special jurisdictional note) :

Ashtabula, Geauga, Lake

Special Jurisdictional Note :

Details :

Prevailing Wage Rate Skilled Crafts

Name of Union: Bricklayer Local 23 Heavy Hwy (A)

Type of Rate: Commercial

Change #:
LCN01-2026ib

Craft:
Bricklayer

Effective Date:
3/25/2026

Effective Date:
3/25/2026

	BHR		Fringe Benefit Payments						Irrevocable Fund		Total PWR	Overtime Rate
			H&W	Pension	App Tr.	Vac.	Annuity	Other	LECET (*)	MISC (*)		
Classification												
Cement Mason Bricklayer Sewer Water Works A	\$34.56		\$10.20	\$9.68	\$0.56	\$0.00	\$1.30	\$0.00	\$0.00	\$0.00	\$56.30	\$73.58
Apprentice	BHR	Percent										
1st year	\$24.19	\$70.00	\$10.20	\$9.68	\$0.56	\$0.00	\$1.30	\$0.00	\$0.00	\$0.00	\$45.93	\$58.03
2nd year	\$27.65	\$80.00	\$10.20	\$9.68	\$0.56	\$0.00	\$1.30	\$0.00	\$0.00	\$0.00	\$49.39	\$63.21
3rd year	\$31.10	\$90.00	\$10.20	\$9.68	\$0.56	\$0.00	\$1.30	\$0.00	\$0.00	\$0.00	\$52.84	\$68.39

(*)Special Calculation Note :

This rate is not for building construction.

This rate applies only to the Cement Masons. All other Bricklaying, PCC, Stone, Tile, Marble, Refractory, Industrial and all other applicable work performed will be performed under the applicable rates for those contracts.

Ratio :

- 3 Journeymen to 1 Apprentice
- 6 Journeymen to 2 Apprentice
- 9 Journeymen to 3 Apprentice
- 12 Journeymen to 4 Apprentice
- 15 Journeymen to 5 Apprentice

Jurisdiction (* denotes special jurisdictional note) :

Adams, Allen, Ashland, Ashtabula, Athens, Auglaize, Belmont, Brown, Butler, Carroll, Champaign, Clark, Clermont, Clinton, Columbiana, Coshocton, Crawford, Cuyahoga, Darke, Defiance, Delaware, Erie, Fairfield, Fayette, Franklin, Fulton, Gallia, Geauga, Greene, Guernsey, Hamilton, Hancock, Hardin, Harrison, Henry, Highland, Hocking, Holmes, Huron, Jackson, Jefferson, Knox, Lake, Lawrence, Licking, Logan, Lorain, Lucas, Madison, Mahoning, Marion, Medina, Meigs, Mercer, Miami, Monroe, Montgomery, Morgan, Morrow, Muskingum, Noble, Ottawa, Paulding, Perry, Pickaway, Pike, Portage, Preble, Putnam, Richland, Ross, Sandusky, Scioto, Seneca, Shelby, Stark, Summit, Trumbull, Tuscarawas, Union, Van Wert, Vinton, Warren, Washington, Wayne

Special Jurisdictional Note :

Details :

Bricklayer Local 23 Heavy Hwy (A): Highway Construction, Sewer, Waterworks And Utility Construction, Industrial & Building Site Heavy Construction, Airport Construction Or Railroad Construction Work.

Bricklayer Local 23 Heavy Hwy (B): Power Plant, Tunnels, Amusement Park, Athletic Stadium Site Work ,Pollution Control, Sewer Plant, Waste Plant, & Water Treatment Facilities, Construction.

Prevailing Wage Rate Skilled Crafts

Name of Union: Bricklayer Local 23 Heavy Hwy (B)

Type of Rate: Commercial

Change #:
LCN01-2026ib

Craft:
Bricklayer

Effective Date:
3/25/2026

Effective Date:
3/25/2026

	BHR		Fringe Benefit Payments					Irrevocable Fund		Total PWR	Overtime Rate	
			H&W	Pension	App Tr.	Vac.	Annuity	Other	LECET (*)			MISC (*)
Classification												
Cement Mason Bricklayer Power Plants Tunnels Amusement Parks B	\$35.56		\$10.20	\$9.68	\$0.57	\$0.00	\$1.30	\$0.00	\$0.00	\$0.00	\$57.31	\$75.09
Apprentice	BHR	Percent										
1st year	\$24.89	\$70.00	\$10.20	\$9.68	\$0.57	\$0.00	\$1.30	\$0.00	\$0.00	\$0.00	\$46.64	\$59.09
2nd year	\$28.45	\$80.00	\$10.20	\$9.68	\$0.57	\$0.00	\$1.30	\$0.00	\$0.00	\$0.00	\$50.20	\$64.42
3rd year	\$32.00	\$90.00	\$10.20	\$9.68	\$0.57	\$0.00	\$1.30	\$0.00	\$0.00	\$0.00	\$53.75	\$69.75

(*)Special Calculation Note :

This rate is not for building construction.

This rate applies only to the Cement Masons. All other Bricklaying, PCC, Stone, Tile, Marble, Refractory, Industrial and all other applicable work performed will be performed under the applicable rates for those contracts.

Ratio :

- 3 Journeymen to 1 Apprentice
- 6 Journeymen to 2 Apprentice
- 9 Journeymen to 3 Apprentice
- 12 Journeymen to 4 Apprentice
- 15 Journeymen to 5 Apprentice

Jurisdiction (* denotes special jurisdictional note) :

Adams, Allen, Ashland, Ashtabula, Athens, Auglaize, Belmont, Brown, Butler, Carroll, Champaign, Clark, Clermont, Clinton, Columbiana, Coshocton, Crawford, Cuyahoga, Darke, Defiance, Delaware, Erie, Fairfield, Fayette, Franklin, Fulton, Gallia, Geauga, Greene, Guernsey, Hamilton, Hancock, Hardin, Harrison, Henry, Highland, Hocking, Holmes, Huron, Jackson, Jefferson, Knox, Lake, Lawrence, Licking, Logan, Lorain, Lucas, Madison, Mahoning, Marion, Medina, Meigs, Mercer, Miami, Monroe, Montgomery, Morgan, Morrow, Muskingum, Noble, Ottawa, Paulding, Perry, Pickaway, Pike, Portage, Preble, Putnam, Richland, Ross, Sandusky, Scioto, Seneca, Shelby, Stark, Summit, Trumbull, Tuscarawas, Union, Van Wert, Vinton, Warren, Washington, Wayne

Special Jurisdictional Note :

Details :

Bricklayer Local 23 Heavy Hwy (A): Highway Construction, Sewer, Waterworks And Utility Construction, Industrial & Building Site Heavy Construction, Airport Construction Or Railroad Construction Work.

Bricklayer Local 23 Heavy Hwy (B): Power Plant, Tunnels, Amusement Park, Athletic Stadium Site Work ,Pollution Control, Sewer Plant, Waste Plant, & Water Treatment Facilities, Construction.

Prevailing Wage Rate Skilled Crafts

Name of Union: Carpenter Commercial Zone NEO 1A

Type of Rate: Commercial

Change #:
LCN01-2025ib

Craft:
Carpenter

Effective Date:
6/18/2025

Effective Date:
6/18/2025

	BHR		Fringe Benefit Payments					Irrevocable Fund		Total PWR	Overtime Rate	
			H&W	Pension	App Tr.	Vac.	Annuity	Other	LECET (*)			MISC (*)
Classification												
Carpenter	\$38.54		\$8.90	\$10.98	\$0.72	\$0.00	\$3.95	\$0.14	\$0.00	\$0.00	\$63.23	\$82.50
Apprentice	BHR	Percent										
1st 3 months	\$23.12	\$60.00	\$8.90	\$0.00	\$0.00	\$0.00	\$0.00	\$0.00	\$0.00	\$0.00	\$32.02	\$43.59
2nd 3 months	\$23.12	\$60.00	\$8.90	\$0.00	\$0.72	\$0.00	\$3.95	\$0.14	\$0.00	\$0.00	\$36.83	\$48.40
2nd 6 months	\$25.05	\$65.00	\$8.90	\$0.00	\$0.72	\$0.00	\$3.95	\$0.14	\$0.00	\$0.00	\$38.76	\$51.29
3rd 6 months	\$26.98	\$70.00	\$8.90	\$0.00	\$0.72	\$0.00	\$3.95	\$0.14	\$0.00	\$0.00	\$40.69	\$54.18
4th 6 months	\$28.91	\$75.00	\$8.90	\$0.00	\$0.72	\$0.00	\$3.95	\$0.14	\$0.00	\$0.00	\$42.62	\$57.07
5th 6 months	\$30.83	\$80.00	\$8.90	\$8.78	\$0.72	\$0.00	\$3.95	\$0.14	\$0.00	\$0.00	\$53.32	\$68.74
6th 6 months	\$32.76	\$85.00	\$8.90	\$9.33	\$0.72	\$0.00	\$3.95	\$0.14	\$0.00	\$0.00	\$55.80	\$72.18
7th 6 months	\$34.69	\$90.00	\$8.90	\$9.88	\$0.72	\$0.00	\$3.95	\$0.14	\$0.00	\$0.00	\$58.28	\$75.62
8th 6 months	\$36.61	\$95.00	\$8.90	\$10.43	\$0.72	\$0.00	\$3.95	\$0.14	\$0.00	\$0.00	\$60.75	\$79.06

(*)Special Calculation Note :

*Other is International Training

Ratio :

1 Journeymen to 1 Apprentice

Jurisdiction (* denotes special jurisdictional note) :

Ashtabula, Cuyahoga, Geauga, Lake

Special Jurisdictional Note :

Details :

Prevailing Wage Rate Skilled Crafts

Name of Union: Carpenter Floorlayer Zone NEO 1A

Type of Rate: Commercial

Change #:
LCN01-2025ib

Craft:
Carpenter

Effective Date:
6/18/2025

Effective Date:
6/18/2025

	BHR		Fringe Benefit Payments						Irrevocable Fund		Total PWR	Overtime Rate
			H&W	Pension	App Tr.	Vac.	Annuity	Other	LECET (*)	MISC (*)		
Classification												
Carpenter Floorlayer	\$38.54		\$8.90	\$10.98	\$0.72	\$0.00	\$3.94	\$0.17	\$0.00	\$0.00	\$63.25	\$82.52
Apprentice	BHR	Percent										
1st 3 months	\$23.12	\$60.00	\$8.90	\$0.00	\$0.00	\$0.00	\$0.00	\$0.00	\$0.00	\$0.00	\$32.02	\$43.59
2nd 3 months	\$23.12	\$60.00	\$8.90	\$0.00	\$0.72	\$0.00	\$3.94	\$0.17	\$0.00	\$0.00	\$36.85	\$48.42
2nd 6 months	\$25.05	\$65.00	\$8.90	\$0.00	\$0.72	\$0.00	\$3.94	\$0.17	\$0.00	\$0.00	\$38.78	\$51.31
3rd 6 months	\$26.98	\$70.00	\$8.90	\$0.00	\$0.72	\$0.00	\$3.94	\$0.17	\$0.00	\$0.00	\$40.71	\$54.20
4th 6 months	\$28.91	\$75.00	\$8.90	\$0.00	\$0.72	\$0.00	\$3.94	\$0.17	\$0.00	\$0.00	\$42.64	\$57.09
5th 6 months	\$30.83	\$80.00	\$8.90	\$8.78	\$0.72	\$0.00	\$3.94	\$0.17	\$0.00	\$0.00	\$53.34	\$68.76
6th 6 months	\$32.76	\$85.00	\$8.90	\$9.33	\$0.72	\$0.00	\$3.94	\$0.17	\$0.00	\$0.00	\$55.82	\$72.20
7th 6 months	\$34.69	\$90.00	\$8.90	\$9.88	\$0.72	\$0.00	\$3.94	\$0.17	\$0.00	\$0.00	\$58.30	\$75.64
8th 6 months	\$36.61	\$95.00	\$8.90	\$10.43	\$0.72	\$0.00	\$3.94	\$0.17	\$0.00	\$0.00	\$60.77	\$79.08

(*)Special Calculation Note :

Other: International Training

Ratio :

1 Journeymen to 1 Apprentice

Jurisdiction (* denotes special jurisdictional note) :

Ashtabula, Cuyahoga, Geauga, Lake

Special Jurisdictional Note :

Details :

Prevailing Wage Rate Skilled Crafts

Name of Union: Carpenter Hev Hwy Zone NHH C1-B

Type of Rate: Commercial

Change #:
LCN01-2025ib

Craft:
Carpenter

Effective Date:
6/18/2025

Effective Date:
6/18/2025

	BHR		Fringe Benefit Payments					Irrevocable Fund		Total PWR	Overtime Rate	
			H&W	Pension	App Tr.	Vac.	Annuity	Other	LECET (*)			MISC (*)
Classification												
Carpenter	\$38.57		\$8.90	\$10.98	\$0.72	\$0.00	\$3.92	\$0.14	\$0.00	\$0.00	\$63.23	\$82.52
Apprentice	BHR	Percent										
1st 3 Months	\$23.14	\$60.00	\$8.90	\$0.00	\$0.00	\$0.00	\$0.00	\$0.00	\$0.00	\$0.00	\$32.04	\$43.61
2nd 3 Months	\$23.14	\$60.00	\$8.90	\$0.00	\$0.72	\$0.00	\$3.92	\$0.14	\$0.00	\$0.00	\$36.82	\$48.39
2nd 6 Months	\$25.07	\$65.00	\$8.90	\$0.00	\$0.72	\$0.00	\$3.92	\$0.14	\$0.00	\$0.00	\$38.75	\$51.29
3rd 6 Months	\$27.00	\$70.00	\$8.90	\$0.00	\$0.72	\$0.00	\$3.92	\$0.14	\$0.00	\$0.00	\$40.68	\$54.18
4th 6 Months	\$28.93	\$75.00	\$8.90	\$0.00	\$0.72	\$0.00	\$3.92	\$0.14	\$0.00	\$0.00	\$42.61	\$57.07
5th 6 Months	\$30.86	\$80.00	\$8.90	\$8.78	\$0.72	\$0.00	\$3.92	\$0.14	\$0.00	\$0.00	\$53.32	\$68.74
6th 6 Months	\$32.78	\$85.00	\$8.90	\$9.33	\$0.72	\$0.00	\$3.92	\$0.14	\$0.00	\$0.00	\$55.79	\$72.19
7th 6 Months	\$34.71	\$90.00	\$8.90	\$9.88	\$0.72	\$0.00	\$3.92	\$0.14	\$0.00	\$0.00	\$58.27	\$75.63
8th 6 Months	\$36.64	\$95.00	\$8.90	\$10.43	\$0.72	\$0.00	\$3.92	\$0.14	\$0.00	\$0.00	\$60.75	\$79.07

(*)Special Calculation Note :

Other: Training

Ratio :

1 Journeymen to 1 Apprentice

Jurisdiction (* denotes special jurisdictional note) :

Ashtabula, Cuyahoga, Geauga, Lake

Special Jurisdictional Note :

Details :

Any construction work as performed within the definitions listed here below, all of which, taken together are "Heavy-Highway Construction" work: "HIGHWAY CONSTRUCTION" work is defined as work performed to provide a facility to accommodate vehicular or pedestrian traffic and includes, but is not limited to, the construction of all streets, roads, expressways, turnpikes, bridges, drainage structures, grade separations, parking lots, rest areas, alleys, sidewalks, guardrails, fences, and sound barriers, but shall not include construction of buildings. "AIRPORT CONSTRUCTION" work is defined as including site preparation, grading, paving, drainage, fences, sidewalks, driveways, parking areas and similar work incidental to the construction of airfields but shall not include the construction of buildings. "HEAVY CONSTRUCTION" work is defined as including, but not limited to grade separations, foundations (does not include building foundations), abutments, retaining walls, shafts, tunnels, subways, elevators, drainage projects, flood control projects, reclamation projects, reservoirs, water supply projects, water development projects, hydro-electric development, utility transmission lines, including right-of-way clearing, locks, dams, dikes, levees, revetments, channels, channel cutoffs, intakes, dredging projects, jetties, breakwater, docks, harbors; and all municipal and utility construction except construction classified as building construction. "RAILROAD CONSTRUCTION" work is defined as including, grading, drainage, placing of rails, crossties, ballast and the construction of bridges, and other incidentals for railroads, street railways construction projects and rapid transit system projects, but shall not include the construction of buildings. "SEWER WATERWORKS AND UTILITY CONSTRUCTION" work is defined as including construction of all storm sewers, sanitary sewers, supplying and distributing waterlines, gas lines, telephone and television conduit, underground electrical lines, and similar utility construction. Main waterline and trunk sewers connecting water works and/or sewage disposal plants are included within this definition. "SUPPORTIVE EXCAVATION AND DEEP FOUNDATIONS" work is all driven and drilled foundations within the building site. "POWER PLANT SITE" work is defined as all work which is inside the property line, but outside the actual building construction. Such work shall include, but is not limited to, the grading and installation of sewer lines, drainage lines, gas lines, telephone and television conduit, underground electrical lines and similar utility construction, parking lots, bridges, roads, streets, sidewalks, reservoirs, ash pits, storage tanks, ramps and other such construction work performed on the work site, but shall not include the actual excavation for the buildings, foundations or footers or construction of the buildings. "POLLUTION CONTROL, SEWAGE PLANT, WASTE PLANT AND WATER TREATMENT FACILITIES CONSTRUCTION" WORK shall be all work in construction of pumping stations, waste and sewage disposal plants, incinerator plants, water treatment plants, filtration plants, solid waste disposal and similar pollution control facilities. "SOLAR & WIND FARM" WORK is considered "HEAVY CONSTRUCTION" and includes all work in the construction of solar fields/farms and wind fields/farms (not installations on buildings).

Prevailing Wage Rate Skilled Crafts

Name of Union: Carpenter Insulation Zone NEO 1A

Type of Rate: Commercial

Change #:
LCN01-2025ib

Craft:
Carpenter

Effective Date:
6/18/2025

Effective Date:
6/18/2025

	BHR		Fringe Benefit Payments						Irrevocable Fund		Total PWR	Overtime Rate
			H&W	Pension	App Tr.	Vac.	Annuity	Other	LECET (*)	MISC (*)		
Classification												
Carpenter Insulation	\$30.83		\$8.90	\$10.98	\$0.72	\$0.00	\$3.95	\$0.14	\$0.00	\$0.00	\$55.52	\$70.94
Apprentice	BHR	Percent										
1st 3 months	\$18.50	\$60.00	\$8.90	\$0.00	\$0.00	\$0.00	\$0.00	\$0.00	\$0.00	\$0.00	\$27.40	\$36.65
2nd 3 months	\$18.50	\$60.00	\$8.90	\$0.00	\$0.72	\$0.00	\$3.95	\$0.14	\$0.00	\$0.00	\$32.21	\$41.46
2nd 6 months	\$20.04	\$65.00	\$8.90	\$0.00	\$0.72	\$0.00	\$3.95	\$0.14	\$0.00	\$0.00	\$33.75	\$43.77
3rd 6 months	\$21.58	\$70.00	\$8.90	\$0.00	\$0.72	\$0.00	\$3.95	\$0.14	\$0.00	\$0.00	\$35.29	\$46.08
4th 6 months	\$23.13	\$75.02	\$8.90	\$0.00	\$0.72	\$0.00	\$3.95	\$0.14	\$0.00	\$0.00	\$36.84	\$48.40
5th 6 months	\$24.66	\$80.00	\$8.90	\$8.78	\$0.72	\$0.00	\$3.95	\$0.14	\$0.00	\$0.00	\$47.15	\$59.49
6th 6 months	\$26.21	\$85.00	\$8.90	\$9.33	\$0.72	\$0.00	\$3.95	\$0.14	\$0.00	\$0.00	\$49.25	\$62.35
7th 6 months	\$27.75	\$90.00	\$8.90	\$9.88	\$0.72	\$0.00	\$3.95	\$0.14	\$0.00	\$0.00	\$51.34	\$65.21
8th 6 month	\$29.29	\$95.00	\$8.90	\$10.43	\$0.72	\$0.00	\$3.95	\$0.14	\$0.00	\$0.00	\$53.43	\$68.07

(*)Special Calculation Note :

*Other is Training

Ratio :

1 Journeymen to 1 Apprentice

Jurisdiction (* denotes special jurisdictional note) :

Ashtabula, Cuyahoga, Geauga, Lake

Special Jurisdictional Note :

Details :

Prevailing Wage Rate Skilled Crafts

Name of Union: Carpenter Millwright NE Zone M1-A

Type of Rate: Commercial

Change #:
LCN01-2025ib

Craft:
Carpenter

Effective Date:
6/18/2025

Effective Date:
6/18/2025

	BHR		Fringe Benefit Payments					Irrevocable Fund		Total PWR	Overtime Rate	
			H&W	Pension	App Tr.	Vac.	Annuity	Other	LECET (*)			MISC (*)
Classification												
Carpenter Millwright	\$36.41		\$8.90	\$11.33	\$0.72	\$0.00	\$6.36	\$0.19	\$0.00	\$0.00	\$63.91	\$82.12
Certified Welder	\$37.41		\$8.90	\$11.33	\$0.72	\$0.00	\$6.36	\$0.19	\$0.00	\$0.00	\$64.91	\$83.62
Layout man on Monorail	\$39.14		\$8.90	\$11.33	\$0.72	\$0.00	\$6.36	\$0.19	\$0.00	\$0.00	\$66.64	\$86.21
Apprentice	BHR	Percent										
1st 6 months	\$21.85	\$60.00	\$8.90	\$11.33	\$0.72	\$0.00	\$6.36	\$0.19	\$0.00	\$0.00	\$49.35	\$60.27
2nd 6 months	\$23.67	\$65.00	\$8.90	\$11.33	\$0.72	\$0.00	\$6.36	\$0.19	\$0.00	\$0.00	\$51.17	\$63.00
3rd 6 months	\$25.49	\$70.00	\$8.90	\$11.33	\$0.72	\$0.00	\$6.36	\$0.19	\$0.00	\$0.00	\$52.99	\$65.73
4th 6 months	\$27.31	\$75.00	\$8.90	\$11.33	\$0.72	\$0.00	\$6.36	\$0.19	\$0.00	\$0.00	\$54.81	\$68.46
5th 6 months	\$29.13	\$80.00	\$8.90	\$11.33	\$0.72	\$0.00	\$6.36	\$0.19	\$0.00	\$0.00	\$56.63	\$71.19
6th 6 months	\$30.95	\$85.00	\$8.90	\$11.33	\$0.72	\$0.00	\$6.36	\$0.19	\$0.00	\$0.00	\$58.45	\$73.92
7th 6 months	\$32.77	\$90.00	\$8.90	\$11.33	\$0.72	\$0.00	\$6.36	\$0.19	\$0.00	\$0.00	\$60.27	\$76.65
8th 6 months	\$34.59	\$95.00	\$8.90	\$11.33	\$0.72	\$0.00	\$6.36	\$0.19	\$0.00	\$0.00	\$62.09	\$79.38

(*)Special Calculation Note :

Other is Training.

Ratio :

1 Journeymen to 1 Apprentice

Jurisdiction (* denotes special jurisdictional note) :

Ashland, Ashtabula, Cuyahoga, Erie, Geauga, Huron, Lake, Lorain, Medina, Portage, Richland, Summit

Special Jurisdictional Note :

Details :

The term "Millwright and Machine Erectors" jurisdiction shall mean the unloading, hoisting, rigging, skidding, moving, dismantling, aligning, erecting, assembling, repairing, maintenance and adjusting of all structures, processing areas either under cover, under ground or elsewhere, required to process material, handle, manufacture or service, be it powered or receiving power manually, by steam, gas, electricity, gasoline, diesel, nuclear, solar, water, air or chemically, and in industries such as and including, which are identified for the purpose of description, but not limited to, the following: woodworking plants; canning industries; steel mills; coffee roasting plants; paper and pulp; cellophane; stone crushing; gravel and sand washing and handling; refineries; grain storage and handling; asphalt plants; sewage disposal; water plants; laundries; bakeries; mixing plants; can, bottle and bag packing plants; textile mills; paint mills; breweries; milk processing plants; power plants; aluminum processing or manufacturing plants; and amusement and entertainment fields. The installation of mechanical equipment in atomic energy plants; installation of reactors in power plants; installation of control rods and equipment in reactors; and installation of mechanical equipment in rocket missile bases, launchers, launching gantry, floating bases, hydraulic escape doors and any and all component parts thereto, either assembled, semi-assembled or disassembled. The installation of, but not limited to, the following: setting-up of all engines, motors, generators, air compressors, fans, pumps, scales, hoppers, conveyors of all types, sizes and their supports; escalators; man lifts; moving sidewalks; hoists; dumb waiters; all types of feeding machinery; amusement devices; mechanical pin setters and spotters in bowling alleys; refrigeration equipment; and the installation of all types of equipment necessary and required to process material either in the manufacturing or servicing. The handling and installation of pulleys, gears, sheaves, fly wheels, air and vacuum drives, worm drives and gear drives directly or indirectly coupled to motors, belts, chains, screws, legs, boots, guards, booth tanks, all bin valves, turn heads and indicators, shafting, bearings, cable sprockets, cutting all key seats in new and old work, troughs, chippers, filters, calendars, rolls, winders, rewinders, slitters, cutters, wrapping machines, blowers, forging machines, rams, hydraulic or otherwise, planing, extruder, ball, dust collectors, equipment in meat packing plants, splicing of ropes and cables. The laying-out, fabrication and installation of protection equipment including machinery guards, making and setting of templates for machinery, fabrication of bolts, nuts, pans, drilling of holes for any equipment which the Millwrights install regardless of materials; all welding and burning regardless of type, fabrication of all lines, hose or tubing used in lubricating machinery installed by Millwrights; grinding, cleaning, servicing and any machine work necessary for any part of any equipment installed by the Millwrights; and the break-in and trial run of any equipment or machinery installed by the Millwrights. It is agreed the Millwrights shall use the layout tools and optic equipment necessary to perform their work.

Prevailing Wage Rate Skilled Crafts

Name of Union: Carpenter Pile Driver Hev Hwy Zone NHH P2-B

Type of Rate: Commercial

Change #:
LCN01-2025ib

Craft:
Carpenter

Effective Date:
6/18/2025

Effective Date:
6/18/2025

	BHR		Fringe Benefit Payments					Irrevocable Fund		Total PWR	Overtime Rate	
			H&W	Pension	App Tr.	Vac.	Annuity	Other	LECET (*)			MISC (*)
Classification												
Carpenter Pile Driver	\$36.34		\$8.85	\$11.33	\$0.72	\$0.00	\$6.48	\$0.19	\$0.00	\$0.00	\$63.91	\$82.08
Diver	\$54.51		\$8.85	\$11.33	\$0.72	\$0.00	\$6.48	\$0.19	\$0.00	\$0.00	\$82.08	\$109.34
Certified Welder	\$37.39		\$8.85	\$11.33	\$0.72	\$0.00	\$6.48	\$0.19	\$0.00	\$0.00	\$64.96	\$83.66
Apprentice	BHR	Percent										
1st 6 months	\$21.80	\$60.00	\$8.85	\$11.33	\$0.72	\$0.00	\$6.48	\$0.19	\$0.00	\$0.00	\$49.37	\$60.28
2nd 6 months	\$23.62	\$65.00	\$8.85	\$11.33	\$0.72	\$0.00	\$6.48	\$0.19	\$0.00	\$0.00	\$51.19	\$63.00
3rd 6 months	\$25.44	\$70.00	\$8.85	\$11.33	\$0.72	\$0.00	\$6.48	\$0.19	\$0.00	\$0.00	\$53.01	\$65.73
4th 6 months	\$27.26	\$75.00	\$8.85	\$11.33	\$0.72	\$0.00	\$6.48	\$0.19	\$0.00	\$0.00	\$54.83	\$68.45
5th 6 months	\$29.07	\$80.00	\$8.85	\$11.33	\$0.72	\$0.00	\$6.48	\$0.19	\$0.00	\$0.00	\$56.64	\$71.18
6th 6 months	\$30.89	\$85.00	\$8.85	\$11.33	\$0.72	\$0.00	\$6.48	\$0.19	\$0.00	\$0.00	\$58.46	\$73.90
7th 6 months	\$32.71	\$90.00	\$8.85	\$11.33	\$0.72	\$0.00	\$6.48	\$0.19	\$0.00	\$0.00	\$60.28	\$76.63
8th 6 months	\$34.52	\$95.00	\$8.85	\$11.33	\$0.72	\$0.00	\$6.48	\$0.19	\$0.00	\$0.00	\$62.09	\$79.35

(*)Special Calculation Note :

*Other is Training

Ratio :

1 Journeymen to 1 Apprentice

Jurisdiction (* denotes special jurisdictional note) :

Ashland, Ashtabula, Cuyahoga, Erie, Geauga, Huron, Lake, Lorain, Medina, Portage, Richland, Summit

Special Jurisdictional Note :

Details :

Pile Drivers duties shall include but not limited to: Pile driving, milling, fashioning, joining assembling, erecting, fastening, or dismantling of all material of wood, plastic, metal, fiber, cork and composition and all other substitute materials: pile driving, cutting, fitting and placing of lagging, and the handling, cleaning, erecting, installing and dismantling of machinery, equipment and erecting pre-engineered metal buildings. Pile Drivers work but not limited to: unloading, assembling, erection, repairs, operation, signaling, dismantling and reloading all equipment that is used for pile driving including pile butts is defined as sheeting or scrap piling. Underwater work that may be required in connection with the installation of piling. The driver and his tender work as a team and shall arrive at their own financial arrangements with the contractor. Any configuration of wood, steel, concrete or composite that is jetted, driven or vibrated onto the ground by conventional pile driving equipment for the purpose of supporting a future load that may be permanent or temporary. The construction of all wharves and docks, including the fabrication and installation of floating docks. Driving bracing, plumbing, cutting off and capping of all piling whether wood, metal, pipe piling or composite, loading, unloading, erecting, framing, dismantling, moving and handling of pile driving equipment piling used in the construction and repair of all wharves, docks, piers, trestles, caissons, cofferdams and erection of all sea walls and breakwaters. All underwater and marine work on bulkheads, wharves, docks, shipyards, caissons, piers, bridges, pipeline, work, viaducts, marine cable and trestles, as well as salvage and reclamation work where divers are employed. Rate shall include carpenters, acoustic and ceiling installers, drywall installers, pile drivers and floorlayers.

Prevailing Wage Rate Skilled Crafts

Name of Union: Cement Mason Local 404

Type of Rate: Commercial

Change #:
LCN01-2024ib

Craft:
Cement Mason

Effective Date:
5/1/2024

Effective Date:
5/1/2024

	BHR		Fringe Benefit Payments						Irrevocable Fund		Total PWR	Overtime Rate
			H&W	Pension	App Tr.	Vac.	Annuity	Other	LECET (*)	MISC (*)		
Classification												
Cement Mason	\$34.88		\$9.40	\$7.10	\$0.63	\$0.00	\$5.95	\$0.08	\$0.00	\$0.00	\$58.04	\$75.48
Apprentice	BHR	Percent										
1st yr	\$20.41	\$58.51	\$9.40	\$7.10	\$0.63	\$0.00	\$2.98	\$0.08	\$0.00	\$0.00	\$40.60	\$50.80
2nd yr	\$25.64	\$73.50	\$9.40	\$7.10	\$0.63	\$0.00	\$2.98	\$0.08	\$0.00	\$0.00	\$45.83	\$58.65
3rd yr	\$29.13	\$83.51	\$9.40	\$7.10	\$0.63	\$0.00	\$2.98	\$0.08	\$0.00	\$0.00	\$49.32	\$63.88
4th yr	\$34.36	\$98.50	\$9.40	\$7.10	\$0.63	\$0.00	\$2.98	\$0.08	\$0.00	\$0.00	\$54.55	\$71.73

(*)Special Calculation Note :

Other is Training Fund

Ratio :

5 Journeymen to 1 Apprentice 2 Journeymen to 1 Apprentice

Jurisdiction (* denotes special jurisdictional note) :

Ashtabula, Cuyahoga, Geauga, Lake, Lorain

Special Jurisdictional Note :

Details :

Prevailing Wage Rate Skilled Crafts

Name of Union: Cement Mason Local 404 Hev Hwy

Type of Rate: Commercial

Change #:
LCN01-2025ib

Craft:
Cement Mason

Effective Date:
5/1/2025

Effective Date:
5/1/2025

	BHR		Fringe Benefit Payments						Irrevocable Fund		Total PWR	Overtime Rate
			H&W	Pension	App Tr.	Vac.	Annuity	Other	LECET (*)	MISC (*)		
Classification												
Cement Mason	\$36.29		\$9.20	\$7.85	\$0.75	\$0.00	\$3.00	\$0.07	\$0.00	\$0.00	\$57.16	\$75.31
Apprentice	BHR	Percent										
1st Year	\$25.40	\$70.00	\$9.20	\$7.85	\$0.75	\$0.00	\$3.00	\$0.07	\$0.00	\$0.00	\$46.27	\$58.97
2nd Year	\$29.03	\$80.00	\$9.20	\$7.85	\$0.75	\$0.00	\$3.00	\$0.07	\$0.00	\$0.00	\$49.90	\$64.42
3rd Year	\$32.66	\$90.00	\$9.20	\$7.85	\$0.75	\$0.00	\$3.00	\$0.07	\$0.00	\$0.00	\$53.53	\$69.86
4th Year	\$34.48	\$95.00	\$9.20	\$7.85	\$0.75	\$0.00	\$3.00	\$0.07	\$0.00	\$0.00	\$55.35	\$72.58

(*)Special Calculation Note :

Other: International Training Fund

Ratio :

1 Journeyman to 1 Apprentice 2 Journeymen to 1 Apprentice thereafter

Jurisdiction (* denotes special jurisdictional note) :

Ashtabula, Cuyahoga, Geauga, Lake, Lorain

Special Jurisdictional Note :

Details :

Highway Construction, Sewer, Waterworks And Utility Construction, Industrial & Building Site, Heavy Construction, Airport Construction Or Railroad Construction Work, Power Plant, Tunnels, Amusement Park, Athletic Stadium Site Work, Pollution Control, Sewer Plant, Waste & Water Plant, Water Treatment Facilities Construction.

Prevailing Wage Rate Skilled Crafts

Name of Union: Electrical Local 673 Inside

Type of Rate: Commercial

Change #:
LCN01-2026ib

Craft:
Electrical

Effective Date:
3/4/2026

Effective Date:
3/4/2026

	BHR		Fringe Benefit Payments					Irrevocable Fund		Total PWR	Overtime Rate	
			H&W	Pension	App Tr.	Vac.	Annuity	Other	LECET (*)			MISC (*)
Classification												
Electrician	\$41.00		\$7.83	\$8.98	\$0.70	\$0.00	\$6.00	\$1.23	\$0.00	\$0.00	\$65.74	\$86.24
Welder	\$45.10		\$7.83	\$8.98	\$0.70	\$0.00	\$6.00	\$1.35	\$0.00	\$0.00	\$69.96	\$92.51
Apprentice	BHR	Percent										
1st Period	\$18.45	\$45.00	\$7.83	\$0.00	\$0.70	\$0.00	\$0.00	\$0.55	\$0.00	\$0.00	\$27.53	\$36.75
2nd Period	\$20.50	\$50.00	\$7.83	\$0.00	\$0.70	\$0.00	\$0.00	\$0.62	\$0.00	\$0.00	\$29.65	\$39.90
3rd Period	\$22.55	\$55.00	\$7.83	\$8.98	\$0.70	\$0.00	\$6.00	\$0.68	\$0.00	\$0.00	\$46.74	\$58.02
4th Period	\$26.65	\$65.00	\$7.83	\$8.98	\$0.70	\$0.00	\$6.00	\$0.80	\$0.00	\$0.00	\$50.96	\$64.28
5th Period	\$30.75	\$75.00	\$7.83	\$8.98	\$0.70	\$0.00	\$6.00	\$0.92	\$0.00	\$0.00	\$55.18	\$70.56
6th Period	\$34.85	\$85.00	\$7.83	\$8.98	\$0.70	\$0.00	\$6.00	\$1.05	\$0.00	\$0.00	\$59.41	\$76.84

(*)Special Calculation Note :

Other: National Electrical Benefit Fund

Ratio :

1 to 3 Journeymen to 2 Apprentices
 4 to 6 Journeymen to 4 Apprentices
 7 to 9 Journeymen to 6 Apprentices

Jurisdiction (* denotes special jurisdictional note) :

Ashtabula*, Geauga*, Lake

Special Jurisdictional Note :

The following townships In Ashtabula County are EXCLUDED: Orwell, Colebrook, Williamsfield, Wayne and Windsor.

In Geauga County the following townships are INCLUDED: Burton, Chardon, Claridon, Hambden, Huntsburg, Montville, Munson, Newbury and Thompson.

Details :

Prevailing Wage Rate Skilled Crafts

Name of Union: Electrical Local 673 Inside Lt Commercial Northern

Type of Rate: Commercial

Change #:
LCN01-2026ib

Craft:
Electrical

Effective Date:
3/4/2026

Effective Date:
3/4/2026

Classification	BHR		Fringe Benefit Payments					Irrevocable Fund		Total PWR	Overtime Rate	
			H&W	Pension	App Tr.	Vac.	Annuity	Other	LECET (*)			MISC (*)
Electrician	\$41.00		\$7.83	\$8.98	\$0.70	\$0.00	\$6.00	\$1.23	\$0.00	\$0.00	\$65.74	\$86.24
Welder	\$45.10		\$7.83	\$8.98	\$0.70	\$0.00	\$6.00	\$1.35	\$0.00	\$0.00	\$69.96	\$92.51
CE-3 12,001-14,000 Hrs	\$31.71		\$6.99	\$0.00	\$0.95	\$0.00	\$0.95	\$0.95	\$0.00	\$0.10	\$41.65	\$57.50
CE-2 10,001-12,000 Hrs	\$24.92		\$6.99	\$0.00	\$0.95	\$0.00	\$0.75	\$0.75	\$0.00	\$0.10	\$34.46	\$46.92
CE-1 8,001-10,000 Hrs	\$22.65		\$6.99	\$0.00	\$0.95	\$0.00	\$0.68	\$0.68	\$0.00	\$0.10	\$32.05	\$43.37
CW-4 6,001-8,000 Hrs	\$20.39		\$6.99	\$0.00	\$0.95	\$0.00	\$0.61	\$0.61	\$0.00	\$0.10	\$29.65	\$39.84
CW-3 4,001-6,000 Hrs	\$18.12		\$6.99	\$0.00	\$0.95	\$0.00	\$0.54	\$0.54	\$0.00	\$0.10	\$27.24	\$36.30
CW-2 2,001-4,000 Hrs	\$16.99		\$6.99	\$0.00	\$0.95	\$0.00	\$0.51	\$0.51	\$0.00	\$0.10	\$26.05	\$34.55
CW-1 0-2,000 Hrs	\$15.86		\$6.99	\$0.00	\$0.95	\$0.00	\$0.48	\$0.48	\$0.00	\$0.10	\$24.86	\$32.79
Apprentice	BHR	Percent										
1st Period	\$18.45	\$45.00	\$7.83	\$0.50	\$0.70	\$0.00	\$0.00	\$0.00	\$0.00	\$0.00	\$27.48	\$36.70
2nd Period	\$20.51	\$50.02	\$7.83	\$0.56	\$0.70	\$0.00	\$0.00	\$0.00	\$0.00	\$0.00	\$29.60	\$39.86
3rd Period	\$22.55	\$55.00	\$7.83	\$0.59	\$0.70	\$0.00	\$5.46	\$0.00	\$0.00	\$0.00	\$46.13	\$57.41
4th Period	\$26.65	\$65.00	\$7.83	\$0.71	\$0.70	\$0.00	\$5.46	\$0.00	\$0.00	\$0.00	\$50.35	\$63.67
5th Period	\$30.75	\$75.00	\$7.83	\$0.82	\$0.70	\$0.00	\$5.46	\$0.00	\$0.00	\$0.00	\$54.56	\$69.94
6th Period	\$34.85	\$85.00	\$7.83	\$0.93	\$0.70	\$0.00	\$5.46	\$0.00	\$0.00	\$0.00	\$58.77	\$76.20

(*)Special Calculation Note :

Other: National Electrical Benefit Fund
Misc: Central Collection Admin Fee

Ratio :

1 to 3 Journeymen to 2 Apprentices
4 to 6 Journeymen to 4 Apprentices
7 to 9 Journeymen to 6 Apprentices

Construction Electrician and Construction Wireman Ratio There shall be a minimum ratio of one inside Journeyman Wireman to every (4) employees of different classifications per jobsite. An Inside Journeyman Wireman is required on the project as the fifth (5th) worker or when apprentices are used

Jurisdiction (* denotes special jurisdictional note) :

Ashtabula*, Geauga*, Lake

Special Jurisdictional Note :

The following townships In Ashtabula County are EXCLUDED: Orwell, Colebrook, Williamsfield, Wayne and Windsor.

In Geauga County the following townships are INCLUDED: Burton, Chardon, Claridon, Hambden, Huntsburg, Montville, Munson, Newbury and Thompson.

Details :

The scope of work for the light commercial agreement shall apply to the following small medical clinics, stand-alone doctor and dentist offices with up to 600 amp service (not attached to a hospital), gas stations/convenience stores, fast food restaurants and franchised chain restaurants including independent bars and taverns, places of worship, funeral homes, nursing homes, assisted living facilities and day-care facilities under 15,000 sq ft, small office, retail/wholesale facilities under 15,000 sq ft with less than 10 units attached, storage units, car washes, express hotels and motels (4 stories or less) without conference or restaurants facilities, residential units (subject to Davis Bacon Rates) small stand-alone manufacturing facilities when free standing and not part of a larger facility (less than 15,000 sq ft) solar projects (500 panels or less) unless other wise covered under this agreement, lighting retrofits (when not associated with remodels involving branch re-circuiting) Lighting retrofits shall be defined as the changing of lamps and ballasts in existing light fixtures and shall also include the one for one replacement of existing fixtures.

Prevailing Wage Rate Skilled Crafts

Name of Union: Electrical Local 673 Lightning Rod

Type of Rate: Commercial

Change #:
OCR01-2022sks

Craft:
Electrical

Effective Date:
11/10/2022

Effective Date:
11/10/2022

	BHR		Fringe Benefit Payments						Irrevocable Fund		Total PWR	Overtime Rate
			H&W	Pension	App Tr.	Vac.	Annuity	Other	LECET (*)	MISC (*)		
Classification												
Electrical Lightning Protection	\$30.44		\$7.50	\$0.91	\$0.00	\$2.84	\$1.83	\$0.00	\$0.00	\$0.00	\$43.52	\$58.74
Apprentice	BHR	Percent										
Lightning Protection Installer 1st day-6 months	\$15.22	\$50.00	\$7.50	\$0.46	\$0.00	\$0.41	\$0.92	\$0.00	\$0.00	\$0.00	\$24.51	\$32.12
Lightning Protection Installer 2nd 6 months	\$16.74	\$55.00	\$7.50	\$0.50	\$0.00	\$0.45	\$1.01	\$0.00	\$0.00	\$0.00	\$26.20	\$34.57
Lightning Protection Installer 3rd 6th months	\$18.26	\$60.00	\$7.50	\$0.55	\$0.00	\$0.89	\$1.10	\$0.00	\$0.00	\$0.00	\$28.30	\$37.44
Lightning Protection Installer 4th 6 months	\$19.79	\$65.00	\$7.50	\$0.59	\$0.00	\$0.97	\$1.19	\$0.00	\$0.00	\$0.00	\$30.04	\$39.93
Lightning Protection Installer 3rd Year	\$21.31	\$70.00	\$7.50	\$0.64	\$0.00	\$1.52	\$1.28	\$0.00	\$0.00	\$0.00	\$32.25	\$42.90
Lightning Protection Installer 4th Year	\$24.35	\$80.00	\$7.50	\$0.73	\$0.00	\$1.73	\$1.46	\$0.00	\$0.00	\$0.00	\$35.77	\$47.95
Lightning Protection Installer 5th Year	\$27.40	\$90.00	\$7.50	\$0.82	\$0.00	\$1.95	\$1.65	\$0.00	\$0.00	\$0.00	\$39.32	\$53.01

(*)Special Calculation Note :

Ratio :

1- 3 Journeyman to 2 Trainee 4-6 Journeyman to 4 Trainee 7-9 Journeyman to 6 Trainee

Jurisdiction (* denotes special jurisdictional note) :

Ashtabula, Geauga, Lake

Special Jurisdictional Note :

Details :

Prevailing Wage Rate Skilled Crafts

Name of Union: Electrical Local 673 Voice Data Video

Type of Rate: Commercial

Change #:
LCN01-2023ib

Craft:
Electrical

Effective Date:
6/14/2023

Effective Date:
6/14/2023

	BHR		Fringe Benefit Payments					Irrevocable Fund		Total PWR	Overtime Rate	
			H&W	Pension	App Tr.	Vac.	Annuity	Other	LECET (*)			MISC (*)
Classification												
Electrical Installer Technician	\$28.95		\$10.98	\$0.87	\$0.70	\$0.00	\$1.36	\$0.00	\$0.00	\$0.00	\$42.86	\$57.34
Communication Technician	\$30.20		\$10.98	\$0.91	\$0.70	\$0.00	\$1.36	\$0.00	\$0.00	\$0.00	\$44.15	\$59.25
Senior Technician	\$31.17		\$10.98	\$0.93	\$0.70	\$0.00	\$1.36	\$0.00	\$0.00	\$0.00	\$45.14	\$60.73
Security Tech Level I	\$28.95		\$10.98	\$0.87	\$0.70	\$0.00	\$1.36	\$0.00	\$0.00	\$0.00	\$42.86	\$57.34
Security Tech Level II	\$30.20		\$10.98	\$0.91	\$0.70	\$0.00	\$1.36	\$0.00	\$0.00	\$0.00	\$44.15	\$59.25
Security Tech Level III	\$31.17		\$10.98	\$0.93	\$0.70	\$0.00	\$1.36	\$0.00	\$0.00	\$0.00	\$45.14	\$60.73
Audio Visual Tech Level I	\$28.95		\$10.98	\$0.87	\$0.70	\$0.00	\$1.36	\$0.00	\$0.00	\$0.00	\$42.86	\$57.34
Audio Visual Tech Level II	\$30.20		\$10.98	\$0.91	\$0.70	\$0.00	\$1.36	\$0.00	\$0.00	\$0.00	\$44.15	\$59.25
Audio Visual Tech Level III	\$31.17		\$10.98	\$0.93	\$0.70	\$0.00	\$1.36	\$0.00	\$0.00	\$0.00	\$45.14	\$60.73
Apprentice	BHR	Percent										
1st 6 Months	\$15.92	\$55.00	\$10.98	\$0.48	\$0.70	\$0.00	\$1.36	\$0.00	\$0.00	\$0.00	\$29.44	\$37.40
2nd 6 Months	\$18.82	\$65.00	\$10.98	\$0.56	\$0.70	\$0.00	\$1.36	\$0.00	\$0.00	\$0.00	\$32.42	\$41.83
2nd Year	\$21.71	\$75.00	\$10.98	\$0.65	\$0.70	\$0.00	\$1.36	\$0.00	\$0.00	\$0.00	\$35.40	\$46.26
3rd Year	\$23.16	\$80.00	\$10.98	\$0.69	\$0.70	\$0.00	\$1.36	\$0.00	\$0.00	\$0.00	\$36.89	\$48.47
4th Year	\$24.61	\$85.00	\$10.98	\$0.74	\$0.70	\$0.00	\$1.36	\$0.00	\$0.00	\$0.00	\$38.39	\$50.69
5th Year	\$26.06	\$90.00	\$10.98	\$0.78	\$0.70	\$0.00	\$1.36	\$0.00	\$0.00	\$0.00	\$39.88	\$52.90

(*)Special Calculation Note :

No special calculations for this skilled craft wage rate are required at this time.

Ratio :

1 to 3 Journeyman to 2 Apprentice 4 to 6 Journeyman to 4 Apprentice 7 to 9 Journeyman to 6 Apprentices

Jurisdiction (* denotes special jurisdictional note) :

Ashtabula*, Geauga*, Lake

Special Jurisdictional Note :

In Ashtabula County the following townships are excluded: (Orwell, Colebrook, Williamsfield, Wayne and Windsor). In Geauga County the following townships are included: (Burton, Chardon, Claridon, Hambden, Huntsburg, Montville, Munson, Newbury and Thompson)

Details :

The following work is EXCLUDED from the Teledata Technician work scope: The installation of computer systems in industrial applications such as assembly lines, robotics, computer controller manufacturing systems. The installation of conduit and/ or raceways shall be installed by Inside Wireman . On sites where there is no Inside Wireman employed, the Teledata Technician may install raceway, or conduit not greater than 10 ft. Fire Alarm work is excluded on all new construction sites or wherever the fire alarm system is installed in conduit All HVAC control work. *Installer Technician: Successful completion of the Installer/Technician Apprenticeship Program or have been certified by the IBEW/NECA Joint Apprenticeship and Training Program as an Installer/Technician. *Communications Technician: At least 2 years experience as a Installer/Technician and a minimum of 12 hours continuous related education or have been certified by an IBEW/NECA Joint Apprenticeship Training Program as a Communication Technician.

Prevailing Wage Rate Skilled Crafts

Name of Union: Electrical Local 71 Cleveland Commercial Projects

Type of Rate: Commercial

Change #:
LCN01-2026ib

Craft:
Electrical

Effective Date:
1/21/2026

Effective Date:
1/21/2026

	BHR		Fringe Benefit Payments					Irrevocable Fund		Total PWR	Overtime Rate	
			H&W	Pension	App Tr.	Vac.	Annuity	Other	LECET (*)			MISC (*)
Classification												
Electrical Lineman	\$61.19		\$7.50	\$1.84	\$0.61	\$0.00	\$14.69	\$1.00	\$0.00	\$0.00	\$86.83	\$117.42
Cable Splicer	\$61.19		\$7.50	\$1.84	\$0.61	\$0.00	\$14.69	\$1.00	\$0.00	\$0.00	\$86.83	\$117.42
Equip. Operator	\$55.07		\$7.50	\$1.65	\$0.55	\$0.00	\$13.22	\$1.00	\$0.00	\$0.00	\$78.99	\$106.53
Groundman 0 to 12 months	\$36.71		\$7.50	\$1.10	\$0.37	\$0.00	\$8.81	\$1.00	\$0.00	\$0.00	\$55.49	\$73.84
Groundman 1 year plus	\$42.83		\$7.50	\$1.28	\$0.43	\$0.00	\$10.28	\$1.00	\$0.00	\$0.00	\$63.32	\$84.73
Apprentice	BHR	Percent										
1st 1000 Hrs	\$36.71	\$60.00	\$7.50	\$1.10	\$0.37	\$0.00	\$8.81	\$1.00	\$0.00	\$0.00	\$55.49	\$73.84
2nd 1000 Hrs	\$39.77	\$65.00	\$7.50	\$1.19	\$0.40	\$0.00	\$9.54	\$1.00	\$0.00	\$0.00	\$59.40	\$79.28
3rd 1000 Hrs	\$42.83	\$70.00	\$7.50	\$1.28	\$0.43	\$0.00	\$10.28	\$1.00	\$0.00	\$0.00	\$63.32	\$84.73
4th 1000 Hrs	\$45.89	\$75.00	\$7.50	\$1.38	\$0.46	\$0.00	\$11.01	\$1.00	\$0.00	\$0.00	\$67.24	\$90.19
5th 1000 Hrs	\$48.95	\$80.00	\$7.50	\$1.47	\$0.49	\$0.00	\$11.75	\$1.00	\$0.00	\$0.00	\$71.16	\$95.64
6th 1000 Hrs	\$52.01	\$85.00	\$7.50	\$1.56	\$0.55	\$0.00	\$12.48	\$1.00	\$0.00	\$0.00	\$75.10	\$101.11
7th 1000 Hrs	\$55.07	\$90.00	\$7.50	\$1.65	\$0.55	\$0.00	\$13.22	\$1.00	\$0.00	\$0.00	\$78.99	\$106.53

(*)Special Calculation Note :

Other: Health Reimbursement Account

Ratio :

1 Journeymen to 1 Apprentice

Jurisdiction (* denotes special jurisdictional note) :

Ashtabula, Cuyahoga, Geauga, Lake, Lorain

Special Jurisdictional Note :

Details :

A groundman when directed shall assist a Journeymen in the performance of his/her work on the ground, including the use of hand tools. Under no circumstances shall this classification climb poles, towers, ladders, or work from an elevated platform or bucket truck. This classification shall not perform work normally assigned to an apprentice lineman. There shall be no more than one (1) Groundman for each two (2) Journeyman except when performing DOT Traffic Signal or Highway lighting work where the ratio can be two (2) Groundman for each Journeyman or Operator.

Prevailing Wage Rate Skilled Crafts

Name of Union: Electrical Local 71 Cleveland Municipal Power & Transit

Type of Rate: Commercial

Change #:
LCN01-2025ib

Craft:
Electrical

Effective Date:
1/21/2026

Effective Date:
1/21/2026

	BHR		Fringe Benefit Payments					Irrevocable Fund		Total PWR	Overtime Rate	
			H&W	Pension	App Tr.	Vac.	Annuity	Other	LECET (*)			MISC (*)
Classification												
Electrical Lineman	\$56.91		\$7.50	\$1.71	\$0.57	\$0.00	\$13.09	\$1.00	\$0.00	\$0.00	\$80.78	\$109.23
Cable Splicer	\$56.91		\$7.50	\$1.71	\$0.57	\$0.00	\$13.09	\$1.00	\$0.00	\$0.00	\$80.78	\$109.23
Equip. Operator	\$51.22		\$7.50	\$1.54	\$0.51	\$0.00	\$11.78	\$1.00	\$0.00	\$0.00	\$73.55	\$99.16
Groundman 0 to 12 months	\$34.15		\$7.50	\$1.02	\$0.34	\$0.00	\$7.85	\$1.00	\$0.00	\$0.00	\$51.86	\$68.94
Groundman 1 Year or More	\$39.84		\$7.50	\$1.20	\$0.40	\$0.00	\$9.16	\$1.00	\$0.00	\$0.00	\$59.10	\$79.02
Apprentice	BHR	Percent										
1st 1000 Hrs	\$34.15	\$60.00	\$7.50	\$1.02	\$0.34	\$0.00	\$7.85	\$1.00	\$0.00	\$0.00	\$51.86	\$68.94
2nd 1000 Hrs	\$36.99	\$65.00	\$7.50	\$1.11	\$0.37	\$0.00	\$8.51	\$1.00	\$0.00	\$0.00	\$55.48	\$73.97
3rd 1000 Hrs	\$39.84	\$70.00	\$7.50	\$1.20	\$0.40	\$0.00	\$9.16	\$1.00	\$0.00	\$0.00	\$59.10	\$79.02
4th 1000 Hrs	\$42.68	\$75.00	\$7.50	\$1.28	\$0.43	\$0.00	\$9.82	\$1.00	\$0.00	\$0.00	\$62.71	\$84.05
5th 1000 Hrs	\$45.53	\$80.00	\$7.50	\$1.37	\$0.46	\$0.00	\$10.47	\$1.00	\$0.00	\$0.00	\$66.33	\$89.09
6th 1000 Hrs	\$48.37	\$85.00	\$7.50	\$1.45	\$0.48	\$0.00	\$11.13	\$1.00	\$0.00	\$0.00	\$69.93	\$94.11
7th 1000 Hrs	\$51.22	\$90.00	\$7.50	\$1.54	\$0.51	\$0.00	\$11.78	\$1.00	\$0.00	\$0.00	\$73.55	\$99.16

(*)Special Calculation Note :

Other: Health Reimbursement Account

Ratio :

1 Journeymen to 1 Apprentice

Jurisdiction (* denotes special jurisdictional note) :

Ashtabula, Cuyahoga, Geauga, Lake, Lorain

Special Jurisdictional Note :

Details :

A groundman when directed shall assist a Journeymen in the performance of his/her work on the ground, including the use of hand tools. Under no circumstances shall this classification climb poles, towers, ladders, or work from an elevated platform or bucket truck. This classification shall not perform work normally assigned to an apprentice lineman. There shall be no more than one (1) Groundman for each two (2) Journeyman except when performing DOT Traffic Signal or Highway lighting work where the ratio can be two (2) Groundman for each Journeyman or Operator.

Prevailing Wage Rate Skilled Crafts

Name of Union: Electrical Local 71 DOT Traffic Signal Highway Lighting Cleveland

Type of Rate: Commercial

Change #:
LCN01-2026ib

Craft:
Electrical

Effective Date:
1/21/2026

Effective Date:
1/21/2026

	BHR		Fringe Benefit Payments					Irrevocable Fund		Total PWR	Overtime Rate	
			H&W	Pension	App Tr.	Vac.	Annuity	Other	LECET (*)			MISC (*)
Classification												
Electrical Lineman	\$45.50		\$7.50	\$1.37	\$0.46	\$0.00	\$10.01	\$0.75	\$0.00	\$0.00	\$65.59	\$88.34
Traffic Signal & Lighting Journeyman	\$45.50		\$7.50	\$1.37	\$0.46	\$0.00	\$10.01	\$0.75	\$0.00	\$0.00	\$65.59	\$88.34
Equipment Operator	\$41.32		\$7.50	\$1.24	\$0.41	\$0.00	\$9.09	\$0.75	\$0.00	\$0.00	\$60.31	\$80.97
Groundman 0 to 1 Year	\$27.06		\$7.50	\$0.81	\$0.27	\$0.00	\$5.95	\$0.75	\$0.00	\$0.00	\$42.34	\$55.87
Groundman 1 Year or more	\$32.09		\$7.50	\$0.96	\$0.32	\$0.00	\$7.06	\$0.75	\$0.00	\$0.00	\$48.68	\$64.73
Apprentice	BHR	Percent										
1st 1,000 Hours	\$27.30	\$60.00	\$7.50	\$0.82	\$0.27	\$0.00	\$6.01	\$0.75	\$0.00	\$0.00	\$42.65	\$56.30
2nd 1,000 Hours	\$29.57	\$65.00	\$7.50	\$0.89	\$0.30	\$0.00	\$6.51	\$0.75	\$0.00	\$0.00	\$45.52	\$60.31
3rd 1,000 Hours	\$31.85	\$70.00	\$7.50	\$0.96	\$0.32	\$0.00	\$7.01	\$0.75	\$0.00	\$0.00	\$48.39	\$64.31
4th 1,000 Hours	\$34.13	\$75.00	\$7.50	\$1.02	\$0.34	\$0.00	\$7.51	\$0.75	\$0.00	\$0.00	\$51.25	\$68.31
5th 1,000 Hours	\$36.40	\$80.00	\$7.50	\$1.09	\$0.36	\$0.00	\$8.01	\$0.75	\$0.00	\$0.00	\$54.11	\$72.31
6th 1,000 Hours	\$40.95	\$90.00	\$7.50	\$1.23	\$0.41	\$0.00	\$9.01	\$0.75	\$0.00	\$0.00	\$59.85	\$80.33

(*)Special Calculation Note :

Other: Health Reimbursement Account

Ratio :

1 Journeymen to 1 Apprentice

Jurisdiction (* denotes special jurisdictional note) :

Ashtabula, Cuyahoga, Geauga, Lake, Lorain

Special Jurisdictional Note :

Details :

A groundman when directed shall assist a Journeymen in the performance of his/her work on the ground, including the use of hand tools. Under no circumstances shall this classification climb poles, towers, ladders, or work from an elevated platform or bucket truck. This classification shall not perform work normally assigned to an apprentice lineman. There shall be no more than one (1) Groundman for each two (2) Journeyman except when performing DOT Traffic Signal or Highway lighting work where the ratio can be two (2) Groundman for each Journeyman or Operator.

Prevailing Wage Rate Skilled Crafts

Name of Union: Electrical Local 71 High Tension Pipe Type Cable

Type of Rate: Commercial

Change #:
LCN01-2026ib

Craft:
Electrical

Effective Date:
1/7/2026

Effective Date:
1/7/2026

	BHR		Fringe Benefit Payments					Irrevocable Fund		Total PWR	Overtime Rate	
			H&W	Pension	App Tr.	Vac.	Annuity	Other	LECET (*)			MISC (*)
Classification												
Electrical Lineman	\$54.94		\$7.50	\$1.65	\$0.55	\$0.00	\$13.19	\$1.00	\$0.00	\$0.00	\$78.83	\$106.30
Certified Lineman Welder	\$54.94		\$7.50	\$1.65	\$0.55	\$0.00	\$13.19	\$1.00	\$0.00	\$0.00	\$78.83	\$106.30
Certified Cable Splicer	\$54.94		\$7.50	\$1.65	\$0.55	\$0.00	\$13.19	\$1.00	\$0.00	\$0.00	\$78.83	\$106.30
Operator A	\$49.20		\$7.50	\$1.48	\$0.49	\$0.00	\$11.81	\$1.00	\$0.00	\$0.00	\$71.48	\$96.08
Operator B	\$43.52		\$7.50	\$1.31	\$0.44	\$0.00	\$10.44	\$1.00	\$0.00	\$0.00	\$64.21	\$85.97
Operator C	\$34.93		\$7.50	\$1.05	\$0.35	\$0.00	\$8.38	\$1.00	\$0.00	\$0.00	\$53.21	\$70.67
Groundman 0-12 months Exp	\$27.47		\$7.50	\$0.82	\$0.27	\$0.00	\$6.59	\$1.00	\$0.00	\$0.00	\$43.65	\$57.38
Groundman 0-12 months Exp w/CDL	\$30.22		\$7.50	\$0.91	\$0.30	\$0.00	\$7.25	\$1.00	\$0.00	\$0.00	\$47.18	\$62.29
Groundman 1 yr or more	\$30.22		\$7.50	\$0.91	\$0.30	\$0.00	\$7.25	\$1.00	\$0.00	\$0.00	\$47.18	\$62.29
Groundman 1 yr or more w/CDL	\$35.71		\$7.50	\$1.07	\$0.36	\$0.00	\$8.57	\$1.00	\$0.00	\$0.00	\$54.21	\$72.06
Equipment Mechanic A	\$43.52		\$7.50	\$1.31	\$0.44	\$0.00	\$10.44	\$1.00	\$0.00	\$0.00	\$64.21	\$85.97
Equipment Mechanic B	\$39.22		\$7.50	\$1.18	\$0.39	\$0.00	\$9.41	\$1.00	\$0.00	\$0.00	\$58.70	\$78.31
Equipment Mechanic C	\$34.92		\$7.50	\$1.05	\$0.35	\$0.00	\$8.38	\$1.00	\$0.00	\$0.00	\$53.20	\$70.66
X-Ray Technician	\$54.94		\$7.50	\$1.65	\$0.55	\$0.00	\$13.19	\$1.00	\$0.00	\$0.00	\$78.83	\$106.30
Apprentice	BHR	Percent										
1st 1000 hrs	\$32.96	\$60.00	\$7.50	\$0.99	\$0.33	\$0.00	\$7.91	\$1.00	\$0.00	\$0.00	\$50.69	\$67.17
2nd 1000 hrs	\$35.71	\$65.00	\$7.50	\$1.07	\$0.36	\$0.00	\$8.57	\$1.00	\$0.00	\$0.00	\$54.21	\$72.06
3rd 1000 hrs	\$38.46	\$70.00	\$7.50	\$1.15	\$0.38	\$0.00	\$9.23	\$1.00	\$0.00	\$0.00	\$57.72	\$76.95

4th 1000 hrs	\$41.20	\$75.00	\$7.50	\$1.24	\$0.41	\$0.00	\$9.89	\$1.00	\$0.00	\$0.00	\$61.24	\$81.84
5th 1000 hrs	\$43.95	\$80.00	\$7.50	\$1.32	\$0.44	\$0.00	\$10.55	\$1.00	\$0.00	\$0.00	\$64.76	\$86.74
6th 1000 hrs	\$46.70	\$85.00	\$7.50	\$1.39	\$0.47	\$0.00	\$11.21	\$1.00	\$0.00	\$0.00	\$68.27	\$91.62
7th 1000 hrs	\$49.45	\$90.00	\$7.50	\$1.48	\$0.49	\$0.00	\$11.87	\$1.00	\$0.00	\$0.00	\$71.79	\$96.52

(*)Special Calculation Note :

Other is Health Reimbursement Account

Ratio :

1 Journeyman to 1 Apprentice

Jurisdiction (* denotes special jurisdictional note) :

Adams, Ashland, Ashtabula, Athens, Auglaize, Belmont, Brown, Butler, Carroll, Champaign, Clark, Clermont, Clinton, Columbiana, Coshocton, Crawford, Cuyahoga, Darke, Delaware, Fairfield, Fayette, Franklin, Gallia, Geauga, Greene, Guernsey, Hamilton, Harrison, Highland, Hocking, Holmes, Jackson, Jefferson, Knox, Lake, Lawrence, Licking, Logan, Lorain, Madison, Mahoning, Marion, Medina, Meigs, Mercer, Miami, Monroe, Montgomery, Morgan, Morrow, Muskingum, Noble, Perry, Pickaway, Pike, Portage, Preble, Richland, Ross, Scioto, Shelby, Stark, Summit, Trumbull, Tuscarawas, Union, Vinton, Warren, Washington, Wayne

Special Jurisdictional Note :

Details :

Operator "A": John Henry Rock Drill, D-6 (or equivalent) and above, Trackhoe Digger, (320 Track excavator), Cranes (greater than 25 tons and less than 45 tons).
 Operator "B": Cranes (greater than 6 tons and up to 25 tons), Backhoes, Road Tractor, Dozer up to D-5, Pressure Digger- wheeled or tracked, all Tension wire Stringing equipment.
 Operator "C": Trench, Backhoe, Riding type vibratory Compactor, Ground Rod Driver, Boom Truck (6 ton & below), Skid Steer Loaders, Material Handler.

Special Notes:

When Cable Splicer helpers are used, they must be a Journeyman Lineman.

Pipe installation, holiday testing, welding, cable splicing operation of vacuum pumps and cable pulling equipment and all work requiring the use of hand tools shall be done by Journeymen and Apprentices. Pipe coating, manhole preparations and conditioning, nitrogen connections and flowmeter installation shall be done by or under the direct supervision of a Journeyman.

At least two (2) Journeyman Linemen in addition to certified lineman welders shall be employed to install high voltage pipe.

When pulling cable, at least six (6) of the workmen shall be no less than Journeyman classifications. When pumping oil, only Journeyman Lineman or equipment operators shall be permitted to operate degasifying and oil pumping equipment

Prevailing Wage Rate Skilled Crafts

Name of Union: Electrical Local 71 Outside Utility Power

Type of Rate: Commercial

Change #:
LCN01-2026ib

Craft:
Electrical

Effective Date:
1/7/2026

Effective Date:
1/7/2026

	BHR		Fringe Benefit Payments					Irrevocable Fund		Total PWR	Overtime Rate	
			H&W	Pension	App Tr.	Vac.	Annuity	Other	LECET (*)			MISC (*)
Classification												
Electrical Lineman	\$52.03		\$7.50	\$1.56	\$0.52	\$0.00	\$12.49	\$1.00	\$0.00	\$0.00	\$75.10	\$101.12
Substation Technician	\$52.03		\$7.50	\$1.56	\$0.50	\$0.00	\$12.49	\$1.00	\$0.00	\$0.00	\$75.08	\$101.09
Cable Splicer	\$54.50		\$7.50	\$1.64	\$0.55	\$0.00	\$13.08	\$1.00	\$0.00	\$0.00	\$78.27	\$105.52
Operator A	\$46.61		\$7.50	\$1.40	\$0.47	\$0.00	\$11.19	\$1.00	\$0.00	\$0.00	\$68.17	\$91.47
Operator B	\$41.17		\$7.50	\$1.23	\$0.41	\$0.00	\$9.87	\$1.00	\$0.00	\$0.00	\$61.18	\$81.77
Operator C	\$33.00		\$7.50	\$0.99	\$0.33	\$0.00	\$7.92	\$1.00	\$0.00	\$0.00	\$50.74	\$67.24
Groundman 0-12 months Exp	\$26.02		\$7.50	\$0.78	\$0.26	\$0.00	\$6.24	\$1.00	\$0.00	\$0.00	\$41.80	\$54.81
Groundman 0-12 months Exp w/CDL	\$28.62		\$7.50	\$0.86	\$0.29	\$0.00	\$6.87	\$1.00	\$0.00	\$0.00	\$45.14	\$59.45
Groundman 1 yr or more	\$28.62		\$7.50	\$0.86	\$0.29	\$0.00	\$6.87	\$1.00	\$0.00	\$0.00	\$45.14	\$59.45
Groundman 1 yr or more w/CDL	\$33.82		\$7.50	\$1.01	\$0.34	\$0.00	\$8.12	\$1.00	\$0.00	\$0.00	\$51.79	\$68.70
Equipment Mechanic A	\$41.17		\$7.50	\$1.23	\$0.41	\$0.00	\$9.87	\$1.00	\$0.00	\$0.00	\$61.18	\$81.77
Equipment Mechanic B	\$37.09		\$7.50	\$1.11	\$0.37	\$0.00	\$8.90	\$1.00	\$0.00	\$0.00	\$55.97	\$74.52
Equipment Mechanic C	\$33.00		\$7.50	\$0.99	\$0.33	\$0.00	\$7.92	\$1.00	\$0.00	\$0.00	\$50.74	\$67.24
Line Truck w/auger	\$36.40		\$7.50	\$1.09	\$0.36	\$0.00	\$8.71	\$1.00	\$0.00	\$0.00	\$55.06	\$73.26
Apprentice	BHR	Percent										
1st 1000 hrs	\$31.22	\$60.00	\$7.50	\$0.94	\$0.31	\$0.00	\$7.49	\$1.00	\$0.00	\$0.00	\$48.46	\$64.07
2nd 1000 hrs	\$33.82	\$65.00	\$7.50	\$1.01	\$0.34	\$0.00	\$8.12	\$1.00	\$0.00	\$0.00	\$51.79	\$68.70
3rd 1000 hrs	\$36.42	\$70.00	\$7.50	\$1.09	\$0.36	\$0.00	\$8.74	\$1.00	\$0.00	\$0.00	\$55.11	\$73.32

4th 1000 hrs	\$39.02	\$75.00	\$7.50	\$1.17	\$0.39	\$0.00	\$9.37	\$1.00	\$0.00	\$0.00	\$58.45	\$77.96
5th 1000 hrs	\$41.62	\$80.00	\$7.50	\$1.25	\$0.44	\$0.00	\$9.99	\$1.00	\$0.00	\$0.00	\$61.80	\$82.61
6th 1000 hrs	\$44.23	\$85.00	\$7.50	\$1.33	\$0.44	\$0.00	\$10.61	\$1.00	\$0.00	\$0.00	\$65.11	\$87.22
7th 1000 hrs	\$46.83	\$90.00	\$7.50	\$1.40	\$0.47	\$0.00	\$11.24	\$1.00	\$0.00	\$0.00	\$68.44	\$91.86

(*)Special Calculation Note :

Other: Health Reimbursement Account

Ratio :

(1) Journeyman Lineman to (1) Apprentice

Jurisdiction (* denotes special jurisdictional note) :

Adams, Ashland, Ashtabula, Athens, Auglaize, Belmont, Brown, Butler, Carroll, Champaign, Clark, Clermont, Clinton, Columbiana, Coshocton, Crawford, Cuyahoga, Darke, Delaware, Fairfield, Fayette, Franklin, Gallia, Geauga, Greene, Guernsey, Hamilton, Harrison, Highland, Hocking, Holmes, Jackson, Jefferson, Knox, Lake, Lawrence, Licking, Logan, Lorain, Madison, Mahoning, Marion, Medina, Meigs, Mercer, Miami, Monroe, Montgomery, Morgan, Morrow, Muskingum, Noble, Perry, Pickaway, Pike, Portage, Preble, Richland, Ross, Scioto, Shelby, Stark, Summit, Trumbull, Tuscarawas, Union, Vinton, Warren, Washington, Wayne

Special Jurisdictional Note :

Details :

Operator "A": John Henry Rock Drill, D-6 (or equivalent) and above, Trackhoe Digger, (320 Track excavator), Cranes (greater than 25 tons and less than 45 tons).
 Operator "B": Cranes (greater than 6 tons and up to 25 tons), Backhoes, Road Tractor, Dozer up to D-5, Pressure Digger- wheeled or tracked, all Tension wire Stringing equipment.
 Operator "C": Trench, Backhoe, Riding type vibratory Compactor, Ground Rod Driver, Boom Truck (6 ton & below), Skid Steer Loaders, Material Handler.

Prevailing Wage Rate Skilled Crafts

Name of Union: Electrical Local 71 Underground Residential Distribution

Type of Rate: Commercial

Change #:
LCN01-2026ib

Craft:
Electrical

Effective Date:
1/7/2026

Effective Date:
1/7/2026

	BHR		Fringe Benefit Payments					Irrevocable Fund		Total PWR	Overtime Rate	
			H&W	Pension	App Tr.	Vac.	Annuity	Other	LECET (*)			MISC (*)
Classification												
URD Electrician	\$39.42		\$7.50	\$1.18	\$0.39	\$0.00	\$9.43	\$1.00	\$0.00	\$0.00	\$58.92	\$78.63
Equipment Operator A	\$35.24		\$7.50	\$1.06	\$0.35	\$0.00	\$8.46	\$1.00	\$0.00	\$0.00	\$53.61	\$71.23
Equipment Operator B	\$32.34		\$7.50	\$0.97	\$0.32	\$0.00	\$7.76	\$1.00	\$0.00	\$0.00	\$49.89	\$66.06
Directional Drill Locator	\$35.24		\$7.50	\$1.06	\$0.35	\$0.00	\$8.46	\$1.00	\$0.00	\$0.00	\$53.61	\$71.23
Directional Drill Operator	\$32.34		\$7.50	\$0.97	\$0.32	\$0.00	\$7.76	\$1.00	\$0.00	\$0.00	\$49.89	\$66.06
Groundman 0-12 months Exp	\$25.50		\$7.50	\$0.77	\$0.26	\$0.00	\$6.12	\$1.00	\$0.00	\$0.00	\$41.15	\$53.90
Groundman 0-12 months Exp w/CDL	\$28.15		\$7.50	\$0.84	\$0.28	\$0.00	\$6.76	\$1.00	\$0.00	\$0.00	\$44.53	\$58.60
Groundman 1 yr or more	\$28.15		\$7.50	\$0.84	\$0.28	\$0.00	\$6.76	\$1.00	\$0.00	\$0.00	\$44.53	\$58.60
Groundman 1 yr or more w/CDL	\$33.47		\$7.50	\$1.00	\$0.33	\$0.00	\$8.03	\$1.00	\$0.00	\$0.00	\$51.33	\$68.06
Apprentice	BHR	Percent										
1st 1000 hrs	\$31.54	\$80.00	\$7.50	\$0.95	\$0.32	\$0.00	\$7.57	\$1.00	\$0.00	\$0.00	\$48.88	\$64.65
2nd 1000 hrs	\$33.51	\$85.00	\$7.50	\$1.01	\$0.34	\$0.00	\$8.04	\$1.00	\$0.00	\$0.00	\$51.40	\$68.16
3rd 1000 hrs	\$35.48	\$90.00	\$7.50	\$1.06	\$0.35	\$0.00	\$8.51	\$1.00	\$0.00	\$0.00	\$53.90	\$71.64
4th 1000 hrs	\$37.45	\$95.00	\$7.50	\$1.12	\$0.37	\$0.00	\$8.99	\$1.00	\$0.00	\$0.00	\$56.43	\$75.16

(*)Special Calculation Note :

Other: Health Reimbursement Account

Ratio :

(1) Journeyman Lineman to (1) Apprentice

Jurisdiction (* denotes special jurisdictional note) :

Adams, Ashland, Ashtabula, Athens, Auglaize, Belmont, Brown, Butler, Carroll, Champaign, Clark, Clermont, Clinton, Columbiana, Coshocton, Crawford, Cuyahoga, Darke, Delaware, Fairfield, Fayette, Franklin, Gallia, Geauga, Greene, Guernsey, Hamilton, Harrison, Highland, Hocking, Holmes, Jackson, Jefferson, Knox, Lake, Lawrence, Licking, Logan, Lorain, Madison, Mahoning, Marion, Medina, Meigs, Mercer, Miami, Monroe, Montgomery, Morgan, Morrow, Muskingum, Noble, Perry, Pickaway, Pike, Portage, Preble, Richland, Ross, Scioto, Shelby, Stark, Summit, Trumbull, Tuscarawas, Union, Vinton, Warren, Washington, Wayne

Special Jurisdictional Note :

Details :

This work applies to projects designated for any outside Underground Residential Distribution construction work for electrical utilities, municipalities and rural electrification projects.

Prevailing Wage Rate Skilled Crafts

Name of Union: Electrical Local 71 Voice Data Video Outside

Type of Rate: Commercial

Change #:
LCN02-2024ib

Craft:
Electrical

Effective Date:
3/6/2024

Effective Date:
3/6/2024

Classification	BHR		Fringe Benefit Payments					Irrevocable Fund		Total PWR	Overtime Rate
			H&W	Pension	App Tr.	Vac.	Annuity	Other	LECET (*)		
Electrical Installer Technician I	\$35.39		\$7.25	\$1.06	\$0.00	\$0.00	\$1.77	\$0.00	\$0.00	\$45.47	\$63.17
Installer Technician II	\$33.37		\$7.25	\$1.00	\$0.00	\$0.00	\$1.67	\$0.00	\$0.00	\$43.29	\$59.98
Installer Repairman	\$33.37		\$7.25	\$1.00	\$0.00	\$0.00	\$1.67	\$0.00	\$0.00	\$43.29	\$59.98
Equipment Operator II	\$24.98		\$7.25	\$0.75	\$0.00	\$0.00	\$1.25	\$0.00	\$0.00	\$34.23	\$46.72
Cable Splicer	\$35.39		\$7.25	\$1.06	\$0.00	\$0.00	\$1.77	\$0.00	\$0.00	\$45.47	\$63.17
Ground Driver W/CDL	\$16.69		\$7.25	\$0.50	\$0.00	\$0.00	\$0.83	\$0.00	\$0.00	\$25.27	\$33.62
Groundman	\$14.57		\$7.25	\$0.44	\$0.00	\$0.00	\$0.73	\$0.00	\$0.00	\$22.99	\$30.28
Apprentice	BHR	Percent									
Trainee F	\$17.70	\$50.01	\$7.25	\$0.53	\$0.00	\$0.89	\$0.00	\$0.00	\$0.00	\$26.37	\$35.22
Trainee E	\$20.53	\$58.00	\$7.25	\$0.62	\$0.00	\$1.03	\$0.00	\$0.00	\$0.00	\$29.43	\$39.69
Trainee D	\$23.36	\$66.00	\$7.25	\$0.70	\$0.00	\$1.17	\$0.00	\$0.00	\$0.00	\$32.48	\$44.16
Trainee C	\$26.19	\$74.00	\$7.25	\$0.79	\$0.00	\$1.31	\$0.00	\$0.00	\$0.00	\$35.54	\$48.63
Trainee B	\$29.02	\$82.00	\$7.25	\$0.87	\$0.00	\$1.45	\$0.00	\$0.00	\$0.00	\$38.59	\$53.10
Trainee A	\$31.85	\$90.00	\$7.25	\$0.96	\$0.00	\$1.59	\$0.00	\$0.00	\$0.00	\$41.65	\$57.58

(*)Special Calculation Note :

Ratio :

1Trainee to 1 Journeyman

Jurisdiction (* denotes special jurisdictional note) :

Adams, Ashland, Ashtabula, Athens, Auglaize, Belmont, Brown, Butler, Carroll, Champaign, Clark, Clermont, Clinton, Columbiana, Coshocton, Crawford, Cuyahoga, Darke, Delaware, Fairfield, Fayette, Franklin, Gallia, Geauga, Greene, Guernsey, Hamilton, Harrison, Highland, Hocking, Holmes, Jackson, Jefferson, Knox, Lake, Lawrence, Licking, Logan, Lorain, Madison, Mahoning, Marion, Medina, Meigs, Mercer, Miami, Monroe, Montgomery, Morgan, Morrow, Muskingum, Noble, Perry, Pickaway, Pike, Portage, Preble, Richland, Ross, Scioto, Shelby, Stark, Summit, Trumbull, Tuscarawas, Union, Vinton, Warren, Washington, Wayne

Special Jurisdictional Note :

Details :

Cable Splicer: Inspect and test lines or cables, analyze results, and evaluate transmission characteristics. Cover conductors with insulation or seal splices with moisture-proof covering. Install, splice, test, and repair cables using tools or mechanical equipment. This will include the splicing of fiber. Installer Technician I: Must know all aspects of telephone and cable work. This is to include aerial, underground, and manhole work. Must know how to climb and run bucket. Must have all the tools required to perform these tasks. Must be able to be responsible for the safety of the crew at all times. Must also have CDL license and have at least 5 years experience. Installer Repairman: Perform tasks of repairing, installing, and testing phone and CATV services. Installer Technician II: Have at least three years of telephone and CATV experience. Must have the knowledge of underground, aerial, and manhole work. Must be able to climb and operate bucket. Must have CDL. Must have all tools needed to perform these tasks. Equipment Operator II: Able to operate a digger derrick or bucket truck. Have at least 3 years of experience and must have a valid CDL license. Groundman W/CDL: Must have a valid CDL license and be able to perform tasks such as: climbing poles, pulling down guys, making up material, and getting appropriate tools for the job. Must have at least 5 year's experience. Groundman: Perform tasks such as: climbing poles, pulling down guys, making up material, and getting appropriate tools for the job. Experience 0-5 years.

Prevailing Wage Rate Skilled Crafts

Name of Union: Elevator Local 17

Type of Rate: Commercial

Change #:
LCN01-2026ib

Craft:
Elevator

Effective Date:
3/11/2026

Effective Date:
3/11/2026

	BHR		Fringe Benefit Payments					Irrevocable Fund		Total PWR	Overtime Rate	
			H&W	Pension	App Tr.	Vac.	Annuity	Other	LECET (*)			MISC (*)
Classification												
Elevator Mechanic	\$66.52		\$16.37	\$11.06	\$0.85	\$5.32	\$10.70	\$2.50	\$0.00	\$0.00	\$113.32	\$146.58
Apprentice	BHR	Percent										
0-6months Probation	\$33.26	\$50.00	\$0.00	\$0.00	\$0.00	\$2.00	\$0.00	\$0.00	\$0.00	\$0.00	\$35.26	\$51.89
1st year	\$36.59	\$55.00	\$16.37	\$11.06	\$0.85	\$2.20	\$10.70	\$1.38	\$0.00	\$0.00	\$79.15	\$97.45
2nd year	\$43.24	\$65.00	\$16.37	\$11.06	\$0.85	\$2.59	\$10.70	\$1.63	\$0.00	\$0.00	\$86.44	\$108.06
3rd year	\$46.56	\$70.00	\$16.37	\$11.06	\$0.85	\$2.79	\$10.70	\$1.75	\$0.00	\$0.00	\$90.08	\$113.36
4th year	\$53.22	\$80.00	\$16.37	\$11.06	\$0.85	\$3.19	\$10.70	\$2.00	\$0.00	\$0.00	\$97.39	\$124.00
Assistant Mechanic	\$53.22	\$80.00	\$16.37	\$11.06	\$0.85	\$4.26	\$10.70	\$2.00	\$0.00	\$0.00	\$98.46	\$125.07
Helper	\$46.56	\$70.00	\$16.37	\$11.06	\$0.85	\$3.72	\$10.70	\$1.75	\$0.00	\$0.00	\$91.01	\$114.29

(*)Special Calculation Note :

Vacation: 6% for employees under 5 years based on regular hourly rate for all hours worked, 8% for employees over 5 years based on regular hourly rate for all hours worked.

Other: Holiday Pay

Ratio :

- 1 Journeyman to 1 Apprentice
- 1 Journeyman to 1 Helper
- 1 Journeyman to 1 Assistant Mechanic

Jurisdiction (* denotes special jurisdictional note) :

Ashtabula, Cuyahoga, Erie, Geauga, Lake, Lorain

Special Jurisdictional Note :

Details :

Prevailing Wage Rate Skilled Crafts

Name of Union: Glazier Local 181

Type of Rate: Commercial

Change #:
LCN01-2025ib

Craft:
Glazier

Effective Date:
5/21/2025

Effective Date:
5/21/2025

	BHR		Fringe Benefit Payments					Irrevocable Fund		Total PWR	Overtime Rate	
			H&W	Pension	App Tr.	Vac.	Annuity	Other	LECET (*)			MISC (*)
Classification												
Glazier	\$35.92		\$9.52	\$11.58	\$0.45	\$0.00	\$0.00	\$0.00	\$0.00	\$0.00	\$57.47	\$75.43
Apprentice	BHR	Percent										
1st Year	\$21.55	\$60.00	\$9.52	\$1.02	\$0.45	\$0.00	\$0.00	\$0.00	\$0.00	\$0.00	\$32.54	\$43.32
2nd Year	\$25.14	\$70.00	\$9.52	\$3.52	\$0.45	\$0.00	\$0.00	\$0.00	\$0.00	\$0.00	\$38.63	\$51.21
3rd Year	\$28.74	\$80.00	\$9.52	\$7.69	\$0.45	\$0.00	\$0.00	\$0.00	\$0.00	\$0.00	\$46.40	\$60.76
4th Year	\$32.33	\$90.00	\$9.52	\$8.53	\$0.45	\$0.00	\$0.00	\$0.00	\$0.00	\$0.00	\$50.83	\$66.99

(*)Special Calculation Note :

No special calculations for this classification.

Ratio :

1 Journeymen to 1 Apprentice

Jurisdiction (* denotes special jurisdictional note) :

Ashtabula, Cuyahoga, Erie*, Geauga, Huron, Lake, Lorain, Medina*, Portage*, Summit*

Special Jurisdictional Note :

Start at the intersection of Route 305 and the eastern boundary line of Portage County. Follow Route 305 west onto Route 82, follow Route 82 west to the intersection of Routes 82,8 and 271, follow Route 271 south to Medina County line west to Route 94, follow Route 94 south to Route 303, follow Route 303 west to Route 252, follow Route 252 south to Route 18, follow Route 18 west to Route 301, follow 301 south to Route 162, follow Route 162 west to Route 58, follow Route 58 south to the Ashland County line, follow the Ashland County line. The eastern part of Route 4 north to Lake Erie is the jurisdiction of Local 181. Local 181 has the jurisdiction on all projects built on the property which borders on the above Routes and/or intersections, wherever a County line is the divider between Local 181 and another Union, the jurisdiction is only to the county line.

Details :

High Pay: All work is defined for the purpose of the agreement as being work which requires that the employee be supported by equipment that hangs from or suspends from the wall or roof of a building or structure. This work shall receive an additional \$1.50 per hour.

Prevailing Wage Rate Skilled Crafts

Name of Union: Ironworker Local 17

Type of Rate: Commercial

Change #:
LCN01-2020fb

Craft:
Ironworker

Effective Date:
12/24/2020

Effective Date:
12/24/2020

	BHR		Fringe Benefit Payments					Irrevocable Fund		Total PWR	Overtime Rate	
			H&W	Pension	App Tr.	Vac.	Annuity	Other	LECET (*)			MISC (*)
Classification												
Ironworker	\$33.83		\$7.94	\$10.00	\$0.67	\$2.10	\$4.50	\$0.00	\$0.00	\$0.00	\$59.04	\$75.96
Apprentice	BHR	Percent										
1st 6 Months	\$16.92	\$50.00	\$7.94	\$10.00	\$0.67	\$2.10	\$4.50	\$0.00	\$0.00	\$0.00	\$42.13	\$50.58
2nd 6 Months	\$18.61	\$55.00	\$7.94	\$10.00	\$0.67	\$2.10	\$4.50	\$0.00	\$0.00	\$0.00	\$43.82	\$53.12
2nd Year 1st 6 Months	\$23.68	\$70.00	\$7.94	\$10.00	\$0.67	\$2.10	\$4.50	\$0.00	\$0.00	\$0.00	\$48.89	\$60.73
2nd Year 2nd 6 Months	\$25.37	\$75.00	\$7.94	\$10.00	\$0.67	\$2.10	\$4.50	\$0.00	\$0.00	\$0.00	\$50.58	\$63.27
3rd Year 1st 6 Months	\$27.06	\$80.00	\$7.94	\$10.00	\$0.67	\$2.10	\$4.50	\$0.00	\$0.00	\$0.00	\$52.27	\$65.81
3rd Year 2nd 6 Months	\$28.76	\$85.00	\$7.94	\$10.00	\$0.67	\$2.10	\$4.50	\$0.00	\$0.00	\$0.00	\$53.97	\$68.34
4th Year 1st 6 Months	\$30.45	\$90.00	\$7.94	\$10.00	\$0.67	\$2.10	\$4.50	\$0.00	\$0.00	\$0.00	\$55.66	\$70.88
4th Year 2nd 6 Months	\$32.14	\$95.00	\$7.94	\$10.00	\$0.67	\$2.10	\$4.50	\$0.00	\$0.00	\$0.00	\$57.35	\$73.42

(*)Special Calculation Note :

No special calculations for this skilled craft wage rate are required at this time.

Ratio :

4 Journeymen to 1 Apprentice on Structural Work 3 Journeymen to 1 Apprentice on Rod Work 2 Journeymen to 1 Apprentice on Finishing, Steel Sash, Stairway and Ornamental Work 1 Apprentice for every Sheeting Gang 1 Journeymen to 2 Apprentice Roadway Signage and Sound Barriers 2 Journeymen to 2 Apprentice Unloading and Erection of Light Gauge Metal Trusses

Jurisdiction (* denotes special jurisdictional note) :

Ashtabula, Cuyahoga, Erie, Geauga, Huron, Lake, Lorain, Medina, Portage, Summit

Special Jurisdictional Note :

West Boundary Line :Sandusky, Ohio: Boundary lines between Local 17 & Local 55 are as follows: Columbus Ave north to Sandusky Bay (and/or Lake Erie): Columbus Ave South to present Route 4: Route 4 South to present Route 99: from Route 99 south to old Route 224-all territory to the west of the boundary line to be the jurisdiction of Local 55.All territory to the East of the boundary line to be the jurisdiction of Local 17.Kelly's Island to be within jurisdiction of Local 17.All bridges,tunnels,viaducts,etc, relative to these boundary lines shall be the jurisdiction of Local 17 South Boundary Line:Canton, Ohio: Boundary lines between Local 17 & Local 550 are as follows: All territory north of old Route 224 line to be the jurisdiction of Local 17. All bridges,tunnels,viaducts,signs,etc, relative to old Route 224 line to be within the jurisdiction of Local 17. All territory south of old Route 224 line is to be within the jurisdiction of Local 550, except for everything within the city limits of Barberton which shall be the jurisdiction of Local 17. Reading from West to East: Route old 224 line: Greenwich Ave-Wooster Road or East Ave. Route old 224 line: New 224 line including Cloverleaf: East Waterloo Road: New 224 line-Attwood Road-Old 224. This will be considered to be the old Route 224 line,except for the city limits of Barberton, Ohio which shall be the jurisdiction of Local 17 Southeast Boundary : Between local 17 and Local 207 are as follows: West of a line from Middlefield to Shalersville to Deerfield, shall be under the jurisdiction of local 17. East of a line from Middlefield, to Shalersville to Deerfield, shall be under the jurisdiction of Local 207. Local 17 & Local 207 have agreed that the Ohio County of Ashtabula shall be as follows: Everything North of Route 6, starting at the Geauga County line, proceeding east to State Route 45, shall be under the jurisdiction of Local 17. Everything South, starting at the Geauga County line shall be under local 207. North Boundary: The East boundary line and the West boundary line continuing North halfway across Lake Erie.

Details :

Prevailing Wage Rate Skilled Crafts

Name of Union: Labor HevHwy 1A

Type of Rate: Commercial

Change #:
LCN02-2025ib

Craft:
Laborer

Effective Date:
6/11/2025

Effective Date:
6/11/2025

Classification	BHR		Fringe Benefit Payments					Irrevocable Fund		Total PWR	Overtime Rate	
			H&W	Pension	App Tr.	Vac.	Annuity	Other	LECET (*)			MISC (*)
Laborer Group 1	\$38.93		\$8.60	\$4.45	\$0.45	\$0.00	\$2.50	\$0.00	\$0.10	\$0.00	\$55.03	\$74.50
Group 2	\$39.10		\$8.60	\$4.45	\$0.45	\$0.00	\$2.50	\$0.00	\$0.10	\$0.00	\$55.20	\$74.75
Group 3	\$39.43		\$8.60	\$4.45	\$0.45	\$0.00	\$2.50	\$0.00	\$0.10	\$0.00	\$55.53	\$75.25
Group 4	\$39.88		\$8.60	\$4.45	\$0.45	\$0.00	\$2.50	\$0.00	\$0.10	\$0.00	\$55.98	\$75.92
Watch Person	\$32.00		\$8.60	\$4.45	\$0.45	\$0.00	\$2.50	\$0.00	\$0.10	\$0.00	\$48.10	\$64.10
Apprentice	BHR	Percent										
0-1000 hrs	\$31.14	\$80.00	\$8.60	\$4.45	\$0.45	\$0.00	\$2.50	\$0.00	\$0.10	\$0.00	\$47.24	\$62.82
1001-2000 hrs	\$33.09	\$85.00	\$8.60	\$4.45	\$0.45	\$0.00	\$2.50	\$0.00	\$0.10	\$0.00	\$49.19	\$65.74
2001-3000 hrs	\$35.04	\$90.00	\$8.60	\$4.45	\$0.45	\$0.00	\$2.50	\$0.00	\$0.10	\$0.00	\$51.14	\$68.66
3001-4000 hrs	\$36.98	\$95.00	\$8.60	\$4.45	\$0.45	\$0.00	\$2.50	\$0.00	\$0.10	\$0.00	\$53.08	\$71.58
More than 4000 hrs	\$38.93	\$100.00	\$8.60	\$4.45	\$0.45	\$0.00	\$2.50	\$0.00	\$0.10	\$0.00	\$55.03	\$74.50

(*)Special Calculation Note :

Watchman have no Apprentices. Tunnel Laborer rate with air-pressurized add \$1.00 to the above wage rate. Commercial Driver's License – Any Laborer required to utilize a valid Commercial Driver's License (CDL), are in compliance with necessary FMCSA regulations and approved by the Contractor to operate a Commercial Motor Vehicle (CMV), shall be paid one dollar (\$1.00) per hour above the base rate for the entirety of their working shift.

Ratio :

1 Journeymen to 1 Apprentice 3 Journeymen to 1 Apprentice thereafter

Jurisdiction (* denotes special jurisdictional note) :

Lake

Special Jurisdictional Note :

Hod Carriers and Common Laborers - Heavy, Highway, Sewer, Waterworks, Utility, Airport, Railroad, Industrial and Building Site, Sewer Plant, Waste Water Treatment Facilities Construction

Details :

Group 1 Laborer (Construction); Plant Laborer or Yardman, Right-of-way Laborer, Landscape Laborer, Highway Lighting Worker, Signalization Worker, (Swimming) Pool Construction Laborer, Utility Man, *Bridge Man, Handyman, Joint Setter, Flagperson, Carpenter Helper, Waterproofing Laborer, Slurry Seal, Seal Coating, Surface Treatment or Road Mix Laborer, Riprap Laborer & Grouter, Asphalt Laborer, Dump Man (batch trucks), Guardrail & Fence Installer, Mesh Handler & Placer, Concrete Curing Applicator, Scaffold Erector, Sign Installer, Hazardous Waste (level D), Diver Helper, Zone Person and Traffic Control. *Bridge Man will perform work as per the October 31, 1949, memorandum on concrete forms, by and between the United Brotherhood of Carpenters and Joiners of America and the Laborers' International Union of North America, which states in; "the moving, cleaning, oiling and carrying to the next point of erection, and the stripping of forms which are not to be re-used, and forms on all flat arch work shall be done by members of the Laborers' International Union of North America." Group 2 Asphalt Raker, Screwman or Paver, Concrete Puddler, Kettle Man (pipeline), All Machine-Driven Tools (Gas, Electric, Air), Mason Tender, Brick Paver, Mortar Mixer, Skid Steer, Sheeting & Shoring Person, Surface Grinder Person, Screedperson, Water Blast, Hand Held Wand, Power Buggy or Power Wheelbarrow, Paint Striper, Plastic fusing Machine Operator, Rodding Machine Operator, Pug Mill Operator, Operator of All Vacuum Devices Wet or Dry, Handling of all Pumps 4 inches and under (gas, air or electric), Diver, Form Setter, Bottom Person, Welder Helper (pipeline), Concrete Saw Person, Cutting with Burning Torch, Pipe Layer, Hand Spiker (railroad), Underground Person (working in sewer and waterline, cleaning, repairing and reconditioning). Tunnel Laborer (without air), Caisson, Cofferdam (below 25 feet deep), Air Track and Wagon Drill, Sandblaster Nozzle Person, Hazardous Waste (level B), ***Lead Abatement, Hazardous Waste (level C) ***Includes the erecting of structures for the removal, including the encapsulation and containment of Lead abatement process. Group 3 Blast and Powder Person, Muckers will be defined as shovel men working directly with the miners, Wrencher (mechanical joints & utility pipeline), Yarner, Top Lander, Hazardous Waste (level A), Concrete Specialist, Curb Setter and Cutter, Grade Checker, Concrete Crew in Tunnels. Utility pipeline Tappers, Waterline, Caulker, Signal Person will receive the rate equal to the rate paid the Laborer classification for which the Laborer is signaling. Group 4 Miner, Welder, Gunite Nozzle Person A.) The Watchperson shall be responsible to patrol and maintain a safe traffic zone including but not limited to barrels, cones, signs, arrow boards, message boards etc. The responsibility of a watchperson is to see that the equipment, job and office trailer etc. are secure.

Prevailing Wage Rate Skilled Crafts

Name of Union: Labor Local 310

Type of Rate: Commercial

Change #: LCN01-2025ib

Craft: Laborer

Effective Date: 5/7/2025

Effective Date: 5/7/2025

Classification	BHR		Fringe Benefit Payments					Irrevocable Fund		Total PWR	Overtime Rate	
			H&W	Pension	App Tr.	Vac.	Annuity	Other	LECET (*)			MISC (*)
Laborer Group 1	\$33.18		\$8.86	\$10.95	\$0.10	\$0.00	\$3.08	\$0.15	\$0.00	\$0.20	\$56.52	\$73.11
Group 2	\$33.66		\$8.86	\$10.95	\$0.10	\$0.00	\$3.08	\$0.15	\$0.00	\$0.20	\$57.00	\$73.83
Group 3	\$33.43		\$8.86	\$10.95	\$0.10	\$0.00	\$3.08	\$0.15	\$0.00	\$0.20	\$56.77	\$73.49
Group 4	\$30.08		\$8.86	\$10.95	\$0.10	\$0.00	\$3.08	\$0.15	\$0.00	\$0.20	\$53.42	\$68.46
Group 5	\$27.58		\$8.86	\$10.95	\$0.10	\$0.00	\$3.08	\$0.15	\$0.00	\$0.20	\$50.92	\$64.71
Group 6	\$29.73		\$8.86	\$10.95	\$0.10	\$0.00	\$3.08	\$0.15	\$0.00	\$0.20	\$53.07	\$67.94
Group 7	\$33.68		\$8.86	\$10.95	\$0.10	\$0.00	\$3.08	\$0.15	\$0.00	\$0.20	\$57.02	\$73.86
Group 8	\$33.83		\$8.86	\$10.95	\$0.10	\$0.00	\$3.08	\$0.15	\$0.00	\$0.20	\$57.17	\$74.09
Group 9	\$28.03		\$8.86	\$10.95	\$0.10	\$0.00	\$3.08	\$0.15	\$0.00	\$0.20	\$51.37	\$65.39
Group 10	\$24.03		\$8.86	\$10.95	\$0.10	\$0.00	\$3.08	\$0.15	\$0.00	\$0.20	\$47.37	\$59.39
Group 11	\$33.33		\$8.86	\$10.95	\$0.10	\$0.00	\$3.08	\$0.15	\$0.00	\$0.20	\$56.67	\$73.34
Group 12	\$33.57		\$8.86	\$10.95	\$0.10	\$0.00	\$3.08	\$0.15	\$0.00	\$0.20	\$56.91	\$73.70
Group 13	\$34.68		\$8.86	\$10.95	\$0.10	\$0.00	\$3.08	\$0.15	\$0.00	\$0.20	\$58.02	\$75.36
Apprentice	BHR	Percent										
1-1000 hours	\$19.91	\$60.00	\$8.86	\$0.00	\$0.10	\$0.00	\$3.08	\$0.15	\$0.00	\$0.20	\$32.30	\$42.25
1001-2000 hours	\$23.23	\$70.00	\$8.86	\$5.48	\$0.10	\$0.00	\$3.08	\$0.15	\$0.00	\$0.20	\$41.10	\$52.71
2001-3000 hours	\$26.54	\$80.00	\$8.86	\$10.95	\$0.10	\$0.00	\$3.08	\$0.15	\$0.00	\$0.20	\$49.88	\$63.16
3001-4000 hours	\$29.86	\$90.00	\$8.86	\$10.95	\$0.10	\$0.00	\$3.08	\$0.15	\$0.00	\$0.20	\$53.20	\$68.13
4001 plus	\$33.18	\$100.00	\$8.86	\$10.95	\$0.10	\$0.00	\$3.08	\$0.15	\$0.00	\$0.00	\$56.52	\$73.11

(*)Special Calculation Note :

Other is Supplemental Unemployment Benefit (SUB).

Ratio :

3 Journeymen to 1 Apprentice

Jurisdiction (* denotes special jurisdictional note) :

Cuyahoga, Geauga, Lake

Special Jurisdictional Note :

Details :

Group 1 - Building and construction Laborers and Tenders; Asbestos Removal - hazardous materials; unloading of furniture and fixtures. Group 2 - Guniting (Machines of all type). Group 3 - Laborers on swinging scaffolds; air track and wagon drill. Group 4 - Drywall stocking and handling. Group 5 - General Landscaping. Group 6 - Final Clean-up (must perform clean-up duties for entire work shift, and excludes demolition work). Group 7 - Blasters, Shooters, Caissons, Well Cylinder, Cofferdams, Mine Workers without air, acid brick tenders. Group 8 - Top man on free standing radial stack; bellman and bottom man in blast furnace and stove. Group 9 - Sewer jet. Group 10 - Heat tender. Group 11 - Firebrick. Group 12 - Mason tender handling carbon block and bottom block for blast furnace stoves, stacks etc. Group 13 - Lansing Burners.

Prevailing Wage Rate Skilled Crafts

Name of Union: Operating Engineers - Building Local 18 - Zone I (A)

Type of Rate: Commercial

Change #:
LCN01-2025ib

Craft:
Operating Engineer

Effective Date:
6/11/2025

Effective Date:
6/11/2025

	BHR		Fringe Benefit Payments					Irrevocable Fund		Total PWR	Overtime Rate	
			H&W	Pension	App Tr.	Vac.	Annuity	Other	LECET (*)			MISC (*)
Classification												
Operator Group A	\$49.41		\$9.51	\$6.25	\$0.95	\$0.00	\$0.00	\$0.09	\$0.00	\$0.10	\$66.31	\$91.02
Operator Group B	\$49.26		\$9.51	\$6.25	\$0.95	\$0.00	\$0.00	\$0.09	\$0.00	\$0.10	\$66.16	\$90.79
Operator Group C	\$47.81		\$9.51	\$6.25	\$0.95	\$0.00	\$0.00	\$0.09	\$0.00	\$0.10	\$64.71	\$88.62
Operator Group D	\$47.03		\$9.51	\$6.25	\$0.95	\$0.00	\$0.00	\$0.09	\$0.00	\$0.10	\$63.93	\$87.45
Operator Group E	\$46.71		\$9.51	\$6.25	\$0.95	\$0.00	\$0.00	\$0.09	\$0.00	\$0.10	\$63.61	\$86.97
Operator Group F	\$39.63		\$9.51	\$6.25	\$0.95	\$0.00	\$0.00	\$0.09	\$0.00	\$0.10	\$56.53	\$76.35
Master Mechanic	\$50.41		\$9.51	\$6.25	\$0.95	\$0.00	\$0.00	\$0.09	\$0.00	\$0.10	\$67.31	\$92.52
Lift Director	\$50.41		\$9.51	\$6.25	\$0.95	\$0.00	\$0.00	\$0.09	\$0.00	\$0.10	\$67.31	\$92.52
Crane 200'-299'	\$50.41		\$9.51	\$6.25	\$0.95	\$0.00	\$0.00	\$0.09	\$0.00	\$0.10	\$67.31	\$92.52
Crane 300' and over	\$50.91		\$9.51	\$6.25	\$0.95	\$0.00	\$0.00	\$0.09	\$0.00	\$0.10	\$67.81	\$93.27
Mobile Concrete Pumps 200'-299'r	\$51.41		\$9.51	\$6.25	\$0.95	\$0.00	\$0.00	\$0.09	\$0.00	\$0.10	\$68.31	\$94.02
Mobile Concrete Pumps 300' and over	\$50.91		\$9.51	\$6.25	\$0.95	\$0.00	\$0.00	\$0.09	\$0.00	\$0.10	\$67.81	\$93.27
Apprentice	BHR	Percent										
1st Year	\$29.56	\$59.82	\$9.51	\$6.25	\$0.95	\$0.00	\$0.00	\$0.09	\$0.00	\$0.10	\$46.46	\$61.24
2nd Year	\$34.48	\$69.78	\$9.51	\$6.25	\$0.95	\$0.00	\$0.00	\$0.09	\$0.00	\$0.10	\$51.38	\$68.62
3rd Year	\$39.41	\$79.76	\$9.51	\$6.25	\$0.95	\$0.00	\$0.00	\$0.09	\$0.00	\$0.10	\$56.31	\$76.01
4th Year	\$44.33	\$89.72	\$9.51	\$6.25	\$0.95	\$0.00	\$0.00	\$0.09	\$0.00	\$0.10	\$61.23	\$83.40

(*)Special Calculation Note :

Other & Misc is Education & Safety and National Training Fund.

Ratio :

For every (3) Operating Engineer Journeymen employed by the company ,there may be employed (1) Registered Apprentice. An apprentice, while employed as part of a crew per Article VIII, paragraph77, will not be subject to the apprenticeship ratios in this collective bargaining agreement.

Jurisdiction (* denotes special jurisdictional note) :

Ashtabula, Cuyahoga, Erie, Geauga, Huron, Lake, Lorain, Medina

Special Jurisdictional Note :

Details :

Note: There will be a 5% increase for the apprentices on top of the percentages listed above provided they are operating mobile equipment. Operating Engineers employed on any piece of equipment requiring a Certified Crane Operator (CCO) certification or employed on cranes involved in pile driving operations shall be paid a premium of one dollar (\$1.00) per hour in addition to the crane rate or any escalated rate that may be in effect.

Group A - A-Frames; " Boiler Operators, Compressor Operators, Hydraulic Pumps & Power Pacs when mounted on a crane or regardless of where said equipment is mounted (piggy-back operation)"; Boom Trucks (all types); Cableways; Cherry Pickers; Combination - Concrete Mixers & Towers; Concrete Pumps; Cranes (all types); Cranes-compact: Track or rubber over 4000lbs. capacity; Cranes- self erecting: stationary, track or truck (all configurations); Derricks (all types); Draglines; Dredges (dipper, clam or suction) 3-man crew; Elevating Graders or Euclid Loaders; Floating Equipment; Gradalls; Helicopter Operators, hoisting building materials; Helicopter Winch Operators, hoisting building materials; Hoes (All types); Hoists (two or more drums); Lift Slab or Panel Jack Operators; Locomotives (all types); Maintenance Engineers (Maintenance Operators and/or Welder); Mixers, paving (multiple drum); Mobile Concrete Pumps with booms; Panelboards, (all types on site); Pile Drivers; Power Shovels; Robotics Equipment Operator/Mechanic; Rotary Drills (all), used on caissons work, wells (all types), Geothermal work and sub-structure work; Rough Terrain Forklifts with Winch/Hoist (when used as a crane); Side Booms; Slip Form Pavers; Straddle Carriers (Building Construction on site); Trench Machines (over 24" wide); Tug Boats; Tunnel Boring Machine (TBM).

Group B - Asphalt Pavers; Bulldozers; CMI type Equipment; End Loaders; Horizontal Directional Drill Locator; Horizontal Directional Drill Operator; Instrument Man; Kolman-type Loaders (Dirt Loading); Lead Greasemen; Mucking Machines; Power Graders; Power Scoops; Power Scrapers; Push Cats; Rotomills; Vermeer Type Concrete Saw.

Group C - Air Compressors, Pressurizing Shafts or Tunnels; Articulating/Straight bed end dumps if assigned by the employer (minus \$4.00 per hour from Group C); All Asphalt Rollers; Fork Lifts; Hoists (with one drum); House Elevators (except those automatic call button controlled); Hydro Excavator (all types C rate) (F rate if a second person is needed) Helper rate; Laser Screeds and like equipment; Man Lifts; Modular Moving and Placement machine (C Rate) (F Rate if second person is needed); Mud Jacks; Portable Hydraulic Gantry (lift system C rate) (F Rate if a second person is needed); Power Boilers (over 15 lbs. pressure); Pump Operators (installing or operating Well Points or other types of Dewatering Systems); Pressure Grouting; Trenchers (24" and under); Utility Operators.

Group D – Brokks with a manufacture's weight of 3,500 lbs. and above; Compressors, on building construction; Conveyors, used for handling building materials; Generators; Guniting Machines; Mixers, more than one bag capacity; Mixers, one bag capacity (side loader); Pavement Breakers (hydraulic or cable); Post Drivers; Post Hole Diggers; Road Widening Trenchers; Rollers; Welder Operators.

Group E - Backfillers and Tampers; Batch Plants; Bar and Joint Installing Machines; Bull Floats; Burlap and Curing Machines; Cleaning Machine Operator (decontamination included); Clefplanes; Concrete Spreading Machines; Crushers; Deckhands; Drum Fireman (asphalt); Farm-type, Tractor, pulling attachments; Finishing Machines; Forklifts (masonry work only); Form Trenchers; High Pressure Pumps (over 1/2" discharge); Hydro Seeders; Pumps (4" and over discharge), provided it is not part of a de-watering system discharged into a common header; Self-Propelled Power Spreaders; Self-Propelled Sub Graders; Submersible Pump (4" and over discharge), provided it is not part of a dewatering system discharged into a common header; Tire Repairman; Tractors, pulling sheepsfoot rollers or graders; Vibratory Compactors with integral power.

Group F - Apprentice/Helpers, Oiler, Signalmen; Barrier Moving Machines (additional duty, paid same rate); Bobcat-type and/or Skid Steer Loader; Bobcat-type and/or Skid Steer Loader with any and all attachments; Brokks with a manufacture's weight less than 3,500 lbs.; Cranes – compact, track or rubber under 4000 lbs. capacity; Geodimeter; Grade Checker; Grinders (all); Inboard/Outboard Motor Boat Launches; Light Plant Operators; Planers (all types); Power Boilers (less than 15 lbs. pressure); Power Driven Heaters (oil fired); Power Scrubbers; Power Sweepers; Pumps (under 4 inch discharge); Rod Man; Rotomills; Saw (concrete Vermeer-type); Submersible Pumps (under 4 inch discharge); Vac Alls; Cutting, burning and fabricating on equipment and their attachments.

Master Mechanic - Master Mechanic

Crane 200'-299' - Boom & Jib 200' feet and over Crane 300' and Over - Boom & Jib 300' and over

Prevailing Wage Rate Skilled Crafts

Name of Union: Operating Engineers - HevHwy Zone I

Type of Rate: Commercial

Change #:
LCN01-2025ib

Craft:
Operating Engineer

Effective Date:
5/1/2025

Effective Date:
5/1/2025

	BHR		Fringe Benefit Payments					Irrevocable Fund		Total PWR	Overtime Rate	
			H&W	Pension	App Tr.	Vac.	Annuity	Other	LECET (*)			MISC (*)
Classification												
Operator Class A	\$47.33		\$9.51	\$6.25	\$0.95	\$0.00	\$0.00	\$0.09	\$0.00	\$0.10	\$64.23	\$87.90
Operator Class B	\$47.23		\$9.51	\$6.25	\$0.95	\$0.00	\$0.00	\$0.09	\$0.00	\$0.10	\$64.13	\$87.75
Operator Class C	\$46.19		\$9.51	\$6.25	\$0.95	\$0.00	\$0.00	\$0.09	\$0.00	\$0.10	\$63.09	\$86.19
Operator Class D	\$44.97		\$9.51	\$6.25	\$0.95	\$0.00	\$0.00	\$0.09	\$0.00	\$0.10	\$61.87	\$84.36
Operator Class E	\$39.68		\$9.51	\$6.25	\$0.95	\$0.00	\$0.00	\$0.09	\$0.00	\$0.10	\$56.58	\$76.42
Master Mechanic	\$48.33		\$9.51	\$6.25	\$0.95	\$0.00	\$0.00	\$0.09	\$0.00	\$0.10	\$65.23	\$89.40
Lift Director	\$48.33		\$9.51	\$6.25	\$0.95	\$0.00	\$0.00	\$0.09	\$0.00	\$0.10	\$65.23	\$89.40
Crane and Mobile Concrete Pump 150' - 179'	\$47.83		\$9.51	\$6.25	\$0.95	\$0.00	\$0.00	\$0.09	\$0.00	\$0.10	\$64.73	\$88.65
Crane and Mobile Concrete Pump 180' - 249'	\$48.33		\$9.51	\$6.25	\$0.95	\$0.00	\$0.00	\$0.09	\$0.00	\$0.10	\$65.23	\$89.40
Crane and Mobile Concrete Pump 250' and Over	\$48.58		\$9.51	\$6.25	\$0.95	\$0.00	\$0.00	\$0.09	\$0.00	\$0.10	\$65.48	\$89.77
Apprentice	BHR	Percent										
1st Year	\$23.67	\$50.00	\$9.51	\$6.25	\$0.95	\$0.00	\$0.00	\$0.09	\$0.00	\$0.10	\$40.57	\$52.40
2nd Year	\$28.40	\$60.00	\$9.51	\$6.25	\$0.95	\$0.00	\$0.00	\$0.09	\$0.00	\$0.10	\$45.30	\$59.50
3rd Year	\$33.13	\$70.00	\$9.51	\$6.25	\$0.95	\$0.00	\$0.00	\$0.09	\$0.00	\$0.10	\$50.03	\$66.60
4th Year	\$37.86	\$80.00	\$9.51	\$6.25	\$0.95	\$0.00	\$0.00	\$0.09	\$0.00	\$0.10	\$54.76	\$73.70
Field Mech Trainee	\$	\$	\$	\$	\$	\$	\$	\$	\$	\$	\$	\$
1st year	\$28.40	\$60.00	\$9.51	\$6.25	\$0.95	\$0.00	\$0.00	\$0.09	\$0.00	\$0.00	\$45.30	\$59.50
2nd year	\$33.13	\$70.00	\$9.51	\$6.25	\$0.95	\$0.00	\$0.00	\$0.09	\$0.00	\$0.00	\$50.03	\$66.60
3rd year	\$37.86	\$80.00	\$9.51	\$6.25	\$0.95	\$0.00	\$0.00	\$0.09	\$0.00	\$0.00	\$54.76	\$73.70
4th year	\$42.60	\$90.00	\$9.51	\$6.25	\$0.95	\$0.00	\$0.00	\$0.09	\$0.00	\$0.00	\$59.50	\$80.80

(*)Special Calculation Note :

Other: Education & Safety Fund Misc: National Training

Ratio :

For every (3) Operating Engineer Journeymen employed by the company, there may be employed (1) Registered Apprentice or Trainee Engineer through the referral when they are available. An Apprentice, while employed as part of a crew per Article VIII, paragraph 68 will not be subject to the apprenticeship ratios in this collective bargaining agreement

Jurisdiction (* denotes special jurisdictional note) :

Ashtabula, Cuyahoga, Erie, Geauga, Lake, Lorain, Medina, Portage, Summit

Special Jurisdictional Note :

Details :

**Apprentices will receive a 10% increase on top of the percentages listed above provided they are operating mobile equipment.

Class A - Air Compressors on Steel Erection; Asphalt Plant Engineers (Cleveland District Only); Barrier Moving Machine; Boiler Operators, Compressor Operators, or Generators, when mounted on a rig; Boom Trucks (all types); Cableways; Cherry Pickers; Combination- Concrete Mixers & Towers; Concrete Plants (over 4 yd capacity); Concrete Pumps; Cranes (all types); Compact Cranes track or rubber over 4,000 pounds capacity; Cranes self-erecting stationary, track or truck; Derricks (all types); Draglines; Dredges dipper, clam or suction; Elevating Graders or Euclid Loaders; Floating Equipment (all types); Gradalls; Helicopter Crew (Operator- hoist or winch); Hoes (all types); Hoisting Engines; Hoisting Engines, on shaft or tunnel work; Hydraulic Gantry (lifting system); Industrial-type Tractors; Jet Engine Dryer (D8 or D9) diesel Tractors; Locomotives (standard gauge); Maintenance Operators/Technicians (class A); Mixers, paving (single or double drum); Mucking Machines; Multiple Scrapers; Piledriving Machines (all types); Power Shovels, Prentice Loader; Quad 9 (double pusher); Rail Tamper (with automatic lifting and aligning device); Refrigerating Machines (freezer operation); Rotary Drills, on caisson work; Rough Terrain Fork Lift with winch/hoist; Side Booms; Slip Form Pavers; Survey Crew Party Chiefs; Tower Derricks; Tree Shredders; Trench Machines (over 24" wide); Truck Mounted Concrete Pumps; Tug Boats; Tunnel Machines and /or Mining Machines; Wheel Excavators.

Class B - Asphalt Pavers; Automatic Subgrade Machines, self-propelled (CMI-type); Bobcat-type and /or Skid Steer Loader with hoe attachment greater than 7000 lbs.; Boring Machine Operators (more than 48 inches); Bulldozers; Concrete Saws, Vermeer type; Endloaders; Horizontal Directional Drill (50,000 ft. lbs. thrust and over); Hydro Milling Machine; Kolman-type Loaders (production type-dirt); Lead Greasemen; Lighting and Traffic Signal Installation Equipment includes all groups or classifications; Maintenance Operators/Technicians, Class B - Material Transfer Equipment (shuttle buggy) Asphalt; Pettibone-Rail Equipment; Power Graders; Power Scrapers; Push Cats; Rotomills (all), Grinders and Planners of all types, Groovers (excluding walk-behinds); Trench Machines (24 inch wide and under).

Class C - A-Frames; Air Compressors, on tunnel work (low Pressure); Articulating/straight bed end dumps if assigned (minus \$4.00 per hour); Asphalt Plant Engineers (Portage and Summit Counties only); Bobcat-type and/or skid steer loader with or without attachments; Drones; Highway Drills (all types); HydroVac/Excavator (when a second person is needed, the rate of pay will be "Class E"); Locomotives (narrow gauge); Material Hoist/Elevators; Mixers, concrete (more than one bag capacity); Mixers, one bag capacity (side loader); Power Boilers (over 15 lbs. pressure); Pump Operators (installing or operating well Points); Pumps (4 inch and over discharge); Railroad Tie Inserter/Remover; Rollers, Asphalt; Rotovator (lime-soil Stabilizer); Switch & Tie Tampers (without lifting and aligning device); Utilities Operators, (small equipment); Welding Machines and Generators.

Class D – Backfillers and Tampers; Ballast Re-locator; Bar and Joint Installing Machines; Batch Plant Operators; Boring Machine Operators (48 inch or less); Bull Floats; Burlap and Curing Machines; Concrete Plants (capacity 4 yds. and under); Concrete Saws (multiple); Conveyors (highway); Crushers; Deckhands; Farm type tractors, with attachments (highway); Finishing Machines; Firemen, Floating Equipment (all types); Fork Lifts (highway), except masonry; Form Trenchers; Hydro Hammers; Hydro Seeders; Pavement Breakers (hydraulic or cable); Plant Mixers; Post Drivers; Post Hole Diggers; Power Brush Burners; Power Form Handling Equipment; Road Widening Trenchers; Rollers (brick, grade, macadam); Self-Propelled Power Spreaders; Self-Propelled Sub-Graders; Steam Firemen; Survey Instrument men; Tractors, pulling sheepsfoot rollers or graders; Vibratory Compactors, with integral power.

Class E - Compressors (portable, Sewer, Heavy and Highway); Cranes-Compact, track or rubber under 4,000 pound capacity; Drum Firemen (asphalt plant); Fueling and greasing (Primary Operator with Specialized CDL Endorsement Add \$3.00/hr); Generators; Inboard-Outboard Motor Boat Launches; Masonry Fork Lifts; Oil Heaters (asphalt plant); Oilers/Helpers; Power Driven Heaters (oil fired); Power Scrubbers; Power Sweepers; Pumps (under 4 inch discharge); Signalperson; Survey Rodmen or Chairmen; Tire Repairmen; VAC/ALLS.

Master Mechanic - Master Mechanic

Cranes and Mobile Concrete Pumps 150' -179' - Boom & Jib 150 - 179 feet Cranes and Mobile Concrete Pumps 180' - 249' - Boom & Jib 180 - 249 feet Cranes and Mobile Concrete Pumps 250' and over - Boom & Jib 250 feet or over

Prevailing Wage Rate Skilled Crafts

Name of Union: Painter Local 505 Drywall

Type of Rate: Commercial

Change #:
LCN01-2025ib

Craft:
Painter

Effective Date:
6/25/2025

Effective Date:
6/25/2025

	BHR		Fringe Benefit Payments						Irrevocable Fund		Total PWR	Overtime Rate
			H&W	Pension	App Tr.	Vac.	Annuity	Other	LECET (*)	MISC (*)		
Classification												
Painter Drywall Finisher	\$35.10		\$9.52	\$7.30	\$0.45	\$0.00	\$3.44	\$0.00	\$0.00	\$0.00	\$55.81	\$73.36
Apprentice	BHR	Percent										
1st Year	\$24.57	\$70.00	\$9.52	\$2.61	\$0.45	\$0.00	\$0.00	\$0.00	\$0.00	\$0.00	\$37.15	\$49.44
2nd Year	\$28.08	\$80.00	\$9.52	\$3.28	\$0.45	\$0.00	\$2.75	\$0.00	\$0.00	\$0.00	\$44.08	\$58.12
3rd Year	\$31.59	\$90.00	\$9.52	\$4.08	\$0.45	\$0.00	\$3.10	\$0.00	\$0.00	\$0.00	\$48.74	\$64.54

(*)Special Calculation Note :

Ratio :

2 Journeyman to 1 Apprentice
3 Journeyman to 1 Apprentice after 9 total tapers

Jurisdiction (* denotes special jurisdictional note) :

Ashtabula, Cuyahoga, Geauga, Lake, Lorain, Portage*, Summit*

Special Jurisdictional Note :

Portage & Summit North of the East-West Turnpike.

Details :

Prevailing Wage Rate Skilled Crafts

Name of Union: Painter Local 639 Sign and Display

Type of Rate: Commercial

Change #:
LCN01-2025ib

Craft:
Painter

Effective Date:
6/18/2025

Effective Date:
6/18/2025

	BHR		Fringe Benefit Payments					Irrevocable Fund		Total PWR	Overtime Rate	
			H&W	Pension	App Tr.	Vac.	Annuity	Other	LECET (*)			MISC (*)
Classification												
Top Mechanic Class A	\$27.53		\$4.50	\$0.00	\$0.00	\$0.00	\$0.00	\$1.45	\$0.00	\$0.00	\$33.48	\$47.25
Top Mechanic Class B	\$27.53		\$4.50	\$0.75	\$0.00	\$0.53	\$0.00	\$1.45	\$0.00	\$0.00	\$34.76	\$48.53
Top Helper Class A	\$22.33		\$4.50	\$0.00	\$0.00	\$0.00	\$0.00	\$1.20	\$0.00	\$0.00	\$28.03	\$39.20
Top Helper Class B	\$22.33		\$4.50	\$0.75	\$0.00	\$0.43	\$0.00	\$1.20	\$0.00	\$0.00	\$29.21	\$40.38
Helper Class A	\$17.19		\$4.50	\$0.00	\$0.00	\$0.00	\$0.00	\$0.90	\$0.00	\$0.00	\$22.59	\$31.19
Helper Class B	\$17.19		\$4.50	\$0.75	\$0.00	\$0.30	\$0.00	\$0.90	\$0.00	\$0.00	\$23.64	\$32.24
New Hire (90 Days)	\$15.75		\$4.50	\$0.00	\$0.00	\$0.00	\$0.00	\$0.55	\$0.00	\$0.00	\$20.80	\$28.68
Apprentice	BHR	Percent										

(*)Special Calculation Note :

Other: Sick, Personal & Holiday Pay Swing Stage Rate: Employees shall receive a differential of \$1.50 per hour for all hours worked on scaffolds four sections or higher, including any boom lifts and swing stage scaffolds. In addition, the rigging and derigging of hanging/suspended swing stage systems and rappelling/bolson chair work of a single employee will qualify for \$1.50 differential, will be paid to a single lead Top Mechanic or single lead Top Helper on any given swing stage job, even when it includes multiple running rigs on a single jobsite.

Ratio :

Jurisdiction (* denotes special jurisdictional note) :

Adams, Allen, Ashland, Ashtabula, Athens, Auglaize, Belmont, Brown, Butler, Carroll, Champaign, Clark, Clermont, Clinton, Columbiana, Coshocton, Crawford, Cuyahoga, Darke, Defiance, Delaware, Erie, Fairfield, Fayette, Franklin, Fulton, Gallia, Geauga, Greene, Guernsey, Hamilton, Hancock, Hardin, Harrison, Henry, Highland, Hocking, Holmes, Huron, Jackson, Jefferson, Knox, Lake, Lawrence, Licking, Logan, Lorain, Lucas, Madison, Mahoning, Marion, Medina, Meigs, Mercer, Miami, Monroe, Montgomery, Morgan, Morrow, Muskingum, Noble, Ottawa, Paulding, Perry, Pickaway, Pike, Portage, Preble, Putnam, Richland, Ross, Sandusky, Scioto, Seneca, Shelby, Stark, Summit, Trumbull, Tuscarawas, Union, Van Wert, Vinton, Warren, Washington, Wayne, Williams, Wood, Wyandot

Special Jurisdictional Note :

Details :

The work performed by employees covered by this rate shall include cleaning and refinishing of architectural metals using chemicals, solvents, coatings and hand-applied lacquer thinner, removing scratches from mirror finished metals, burnishing of bronze, statuary finishes on exterior and interior surfaces during the course of the restoration and maintenance of architectural metals, and other specialty metal finishing work, and the use of all tools required to perform such work, including but not limited to polishes, spray equipment and scaffolding. Class A: Less Than 1 Year of Service Class B: More Than 1 Year of Service Top Mechanic: Top Mechanic shall be responsible for ensuring the highest quality of workmanship by Helpers, and be highly competent and knowledgeable in the following areas: coatings, both solvent and waterborne, spraying ability, stainless steel, aluminum and bronze finishing, scaffolding and swing stage work. The Top Mechanic shall also be responsible for providing necessary training of employees in lower classifications and for directing all employees in his/her crew to perform their responsibilities in a productive and efficient manner. Top Helper: For existing Top Helpers at the time of this Agreement shall, in addition to performing the responsibilities of a Helper, be responsible and accountable for the setup, breakdown, safety and quality of the Company's product. Helper: A Helper shall be responsible for performing tasks in refinishing, compliance with safety procedures, setting up and breaking down job sites, setting up and breaking down scaffolding and swing stages, preparing surfaces for refinishing, including but not limited to masking and stripping, cleaning, oxidizing, polishing and scratch removal on various finishes.

Prevailing Wage Rate Skilled Crafts

Name of Union: Painter Local 639 Zone 1 Sign

Type of Rate: Commercial

Change #:
LCN01-2025ib

Craft:
Painter

Effective Date:
7/30/2025

Effective Date:
7/30/2025

	BHR	Fringe Benefit Payments						Irrevocable Fund		Total PWR	Overtime Rate
		H&W	Pension	App Tr.	Vac.	Annuity	Other	LECET (*)	MISC (*)		
Classification											
Class A: Painter Sign Erector/Service/Pattern/Metal Fab/Neon	\$26.28	\$8.91	\$5.57	\$0.25	\$0.79	\$0.00	\$1.10	\$0.00	\$0.00	\$42.90	\$56.04
Class B: Painter Sign Erector/Service/Pattern/Metal Fab/Neon	\$26.28	\$8.91	\$5.57	\$0.25	\$1.58	\$0.00	\$1.10	\$0.00	\$0.00	\$43.69	\$56.83
Class C: Painter Sign Erector/Service/Pattern/Metal Fab/Neon	\$26.28	\$8.91	\$5.57	\$0.25	\$2.37	\$0.00	\$1.10	\$0.00	\$0.00	\$44.48	\$57.62
Class D: Painter Sign Erector/Service/Pattern/Metal Fab/Neon	\$26.28	\$8.91	\$5.57	\$0.25	\$3.15	\$0.00	\$1.10	\$0.00	\$0.00	\$45.26	\$58.40
Class A: Computer Operator, Router, Spray Painter/Wood	\$24.60	\$8.91	\$5.57	\$0.25	\$0.76	\$0.00	\$1.06	\$0.00	\$0.00	\$41.15	\$53.45
Class B: Computer Operator, Router, Spray Painter/Wood	\$24.60	\$8.91	\$5.57	\$0.25	\$1.51	\$0.00	\$1.06	\$0.00	\$0.00	\$41.90	\$54.20
Class C: Computer Operator, Router, Spray Painter/Wood	\$24.60	\$8.91	\$5.57	\$0.25	\$2.27	\$0.00	\$1.06	\$0.00	\$0.00	\$42.66	\$54.96
Class D: Computer Operator, Router, Spray Painter/Wood	\$24.60	\$8.91	\$5.57	\$0.25	\$3.03	\$0.00	\$1.06	\$0.00	\$0.00	\$43.42	\$55.72

Class A: Final Assembly, Helper	\$19.62	\$8.91	\$5.57	\$0.25	\$0.66	\$0.00	\$0.92	\$0.00	\$0.00	\$35.93	\$45.74
Class B: Final Assembly, Helper	\$19.62	\$8.91	\$5.57	\$0.25	\$1.32	\$0.00	\$0.92	\$0.00	\$0.00	\$36.59	\$46.40
Class C: Final Assembly, Helper	\$19.62	\$8.91	\$5.57	\$0.25	\$1.98	\$0.00	\$0.92	\$0.00	\$0.00	\$37.25	\$47.06
Class D: Final Assembly, Helper	\$19.62	\$8.91	\$5.57	\$0.25	\$2.64	\$0.00	\$0.92	\$0.00	\$0.00	\$37.91	\$47.72
Apprentice	BHR	Percent									
1-2000 hrs	\$13.14	\$50.00	\$8.91	\$5.57	\$0.25	\$0.00	\$0.75	\$0.00	\$0.00	\$28.62	\$35.19
2001-3000 hrs	\$14.45	\$55.00	\$8.91	\$5.57	\$0.25	\$0.56	\$0.79	\$0.00	\$0.00	\$30.53	\$37.75
3001-4000 hrs	\$15.77	\$60.00	\$8.91	\$5.57	\$0.25	\$0.59	\$0.82	\$0.00	\$0.00	\$31.91	\$39.80
4001-5000 hrs	\$17.08	\$65.00	\$8.91	\$5.57	\$0.25	\$1.22	\$0.86	\$0.00	\$0.00	\$33.89	\$42.43
5001-6000 hrs	\$18.40	\$70.00	\$8.91	\$5.57	\$0.25	\$1.27	\$0.89	\$0.00	\$0.00	\$35.29	\$44.49
6001-7000 hrs	\$22.34	\$85.00	\$8.91	\$5.57	\$0.25	\$1.43	\$1.00	\$0.00	\$0.00	\$39.50	\$50.67
7001-8000 hrs	\$23.65	\$90.00	\$8.91	\$5.57	\$0.25	\$1.48	\$1.03	\$0.00	\$0.00	\$40.89	\$52.71

(*)Special Calculation Note :

Other: Holiday Pay

Apprentice Pay Rate should be based on proper Classification.

Any employee working over 100 ft. above the ground shall receive \$1.00 per hour additional pay.

Ratio :

Jurisdiction (* denotes special jurisdictional note) :

Ashland, Ashtabula, Cuyahoga, Geauga, Lake, Medina, Portage, Richland, Summit

Special Jurisdictional Note :

Details :

Class A Worker: More than 1 year but less that 2 years

Class B Worker: More than 2 years but less than 10 years

Class C Worker: More than 10 years but less that 20 years

Class D Worker: More than 20 years

Prevailing Wage Rate Skilled Crafts

Name of Union: Painter Local 707

Type of Rate: Commercial

Change #:
LCN01-2025ib

Craft:
Painter

Effective Date:
7/16/2025

Effective Date:
7/16/2025

	BHR		Fringe Benefit Payments					Irrevocable Fund		Total PWR	Overtime Rate
			H&W	Pension	App Tr.	Vac.	Annuity	Other	LECET (*)		
Classification											
Painter Brush Roll	\$35.45		\$9.52	\$6.08	\$0.45	\$0.00	\$4.15	\$0.00	\$0.00	\$55.65	\$73.38
Paperhanger	\$35.45		\$9.52	\$6.08	\$0.45	\$0.00	\$4.15	\$0.00	\$0.00	\$55.65	\$73.38
REPAINT Brush Roll & Paperhanger	\$33.95		\$9.52	\$6.08	\$0.45	\$0.00	\$4.15	\$0.00	\$0.00	\$54.15	\$71.13
Apprentice	BHR	Percent									
1st Year	\$23.04	\$65.00	\$9.52	\$1.64	\$0.45	\$0.00	\$0.00	\$0.00	\$0.00	\$34.65	\$46.17
2nd Year	\$26.59	\$75.00	\$9.52	\$2.25	\$0.45	\$0.00	\$2.91	\$0.00	\$0.00	\$41.72	\$55.02
3rd Year	\$30.13	\$85.00	\$9.52	\$2.70	\$0.45	\$0.00	\$3.32	\$0.00	\$0.00	\$46.12	\$61.19
4th Year	\$33.68	\$95.00	\$9.52	\$3.75	\$0.45	\$0.00	\$3.74	\$0.00	\$0.00	\$51.14	\$67.98

(*)Special Calculation Note :

Apprentice pay based on percentage of above appropriate classification.

The following Premiums shall be added to proper classification in full including apprentice rates:

- Spray Painting: \$.70 per hour
- Sandblasting and buffing: \$.40 per hour
- Height pay (Over 100ft): \$.50 per hour
- Fiberglass Insulator & Catalytic material applicator: \$.70 per hour
- Application of Catalytic materials under class 3 hazardous per MSDS- add \$.65 per hour
- Application of Catalytic materials under class 4 hazardous per MSDS- add \$1.00 per hour

Ratio :

1 Apprentice to 1 Journeyman

Jurisdiction (* denotes special jurisdictional note) :

Ashtabula, Cuyahoga, Geauga, Lake, Lorain, Portage*, Summit*

Special Jurisdictional Note :

Portage & Summit North of the East-West Turnpike.

Details :

Repaint: 20% or less of new surfaces. A general contractor holding a construction contract does not constitute the rate of pay. Bridge work, tanks, towers and all work covered by NMA, PLA, GPA is excluded from any repaint rate.

Prevailing Wage Rate Skilled Crafts

Name of Union: Painter Local 707 HvyHwy

Type of Rate: Commercial

Change #:
LCN01-2025ib

Craft:
Painter

Effective Date:
7/16/2025

Effective Date:
7/16/2025

Classification	BHR	Fringe Benefit Payments						Irrevocable Fund		Total PWR	Overtime Rate
		H&W	Pension	App Tr.	Vac.	Annuity	Other	LECET (*)	MISC (*)		
Class 1: Bridge Blaster	\$41.71	\$9.52	\$6.08	\$0.45	\$0.00	\$4.15	\$0.00	\$0.00	\$0.00	\$61.91	\$82.77
Class 2: Bridge Painter, Rigger, Containment Builder, Spot Blaster	\$38.91	\$9.52	\$6.08	\$0.45	\$0.00	\$4.15	\$0.00	\$0.00	\$0.00	\$59.11	\$78.56
Class 3: Equipment Operator/ Field Mechanic, Grit Reclamation, Paint Mixer, Traffic Control Boat Person, Driver (0-5 Years Exp.)	\$31.71	\$9.52	\$6.08	\$0.45	\$0.00	\$4.15	\$0.00	\$0.00	\$0.00	\$51.91	\$67.77
Class 3: Equipment Operator/ Field Mechanic, Grit Reclamation, Paint Mixer, Traffic Control Boat Person, Driver (5 Plus Years Exp.)	\$34.71	\$9.52	\$6.08	\$0.45	\$0.00	\$4.15	\$0.00	\$0.00	\$0.00	\$54.91	\$72.27
Class 4: Concrete Sealing, Concrete Blasting/ Power Washing/ Etc	\$30.71	\$9.52	\$6.08	\$0.45	\$0.00	\$4.15	\$0.00	\$0.00	\$0.00	\$50.91	\$66.27

Class 5: Quality Control/Q uality Assurance , Traffic Safety, Competen t Person	\$34.71		\$9.52	\$6.08	\$0.45	\$0.00	\$4.15	\$0.00	\$0.00	\$0.00	\$54.91	\$72.27
Apprentice	BHR	Percent										
1st Year	\$27.11	\$65.00	\$9.52	\$1.64	\$0.45	\$0.00	\$0.00	\$0.00	\$0.00	\$0.00	\$38.72	\$52.27
2nd Year	\$31.28	\$75.00	\$9.52	\$2.25	\$0.45	\$0.00	\$2.91	\$0.00	\$0.00	\$0.00	\$46.41	\$62.05
3rd Year	\$35.45	\$85.00	\$9.52	\$2.70	\$0.45	\$0.00	\$3.32	\$0.00	\$0.00	\$0.00	\$51.44	\$69.17

(*)Special Calculation Note :

Apprentice pay based on percentage of above appropriate classification.

Application of Catalytic materials under class 3 hazardous per MSDS- add .65 per hour to the above Job Classification basic hourly rate.

Application of Catalytic materials under class 4 hazardous per MSDS- add 1.00 per hour to the above Job Classification basic hourly rate.

Ratio :

1 Apprentice to 1 Journeyman

Jurisdiction (* denotes special jurisdictional note) :

Ashtabula, Cuyahoga, Geauga, Lake, Lorain, Portage*, Summit*

Special Jurisdictional Note :

Portage & Summit North of the East-West Turnpike.

Details :

Painter Bridge Class 2 is Defined as; Bridge Painter, Rigger, Containment Builder

Concrete Sealing: on highway work, scaling of concrete surfaces, the treating and sealing of bridge decks, the painting and staining of concrete, including the abutments, barricades, noise barriers, lane dividers, etc.

Prevailing Wage Rate Skilled Crafts

Name of Union: Pipefitter Local 120

Type of Rate: Commercial

Change #:
LCN01-2025ib

Craft:
Pipefitter

Effective Date:
6/11/2025

Effective Date:
6/11/2025

	BHR		Fringe Benefit Payments					Irrevocable Fund		Total PWR	Overtime Rate	
			H&W	Pension	App Tr.	Vac.	Annuity	Other	LECET (*)			MISC (*)
Classification												
Pipefitter	\$49.17		\$13.05	\$11.80	\$1.27	\$0.00	\$3.50	\$0.20	\$0.00	\$0.00	\$78.99	\$103.58
Apprentice	BHR	Percent										
1st year	\$23.83	\$48.46	\$5.70	\$0.00	\$1.27	\$0.00	\$0.00	\$0.00	\$0.00	\$0.00	\$30.80	\$42.71
2nd year	\$24.57	\$49.97	\$12.23	\$7.20	\$1.27	\$0.00	\$0.88	\$0.20	\$0.00	\$0.00	\$46.35	\$58.64
3rd year	\$28.45	\$57.86	\$12.23	\$7.20	\$1.27	\$0.00	\$0.88	\$0.20	\$0.00	\$0.00	\$50.23	\$64.45
4th year	\$33.89	\$68.92	\$12.23	\$7.20	\$1.27	\$0.00	\$0.88	\$0.20	\$0.00	\$0.00	\$55.67	\$72.61
5th year	\$37.78	\$76.84	\$12.23	\$7.20	\$1.27	\$0.00	\$0.88	\$0.20	\$0.00	\$0.00	\$59.56	\$78.45

(*)Special Calculation Note :

OTHER: SUPPLEMENTAL UNEMPLOYMENT BENEFITS

Ratio :

1 Journeyman to 1 Apprentice 2-4 Journeymen to 2 Apprentices 5-7 Journeymen to 3 Apprentices 3 to 1 on jobs with 12 or more journeymen

Jurisdiction (* denotes special jurisdictional note) :

Ashtabula, Cuyahoga, Geauga, Lake, Medina*, Summit*

Special Jurisdictional Note :

Summit County - North of State Route 303 including work within the corporate limits of the City of Hudson, that portion of Medina County North of State Route 18 and Smith Road and including work within the corporate limits of the City of Medina.

Details :

Under pipefitter duties shall include - steam and hot water heating boilers and related controls such as automatic feedwater and low water cut-offs, safety relief valves and gas trains; steam regulators, traps, steam valves, steam heaters, steam and hot water heating coils; feedwater lines to boilers, condensate pumps, condensate tanks and related piping to boilers, expansion tanks and controls on hot water heating systems; refrigeration and air conditioning systems that are separate from one another and are connected through piping; install, calibrate and maintain pneumatic temperature controls and piping for heating and cooling devices; piping, pumps and controls on the fluent water system in water treatment plants; hose cabinets and automatic fire sprinkler systems; underground water supply piping and devices; all fire stopping of piping systems; to operate a pipe cutting machine, to thread pipe by machine or hand dies; to do oxyacetylene and electric welding on iron and steel pipes when required; to perform other tasks when assigned.

Prevailing Wage Rate Skilled Crafts

Name of Union: Pipefitter Local 120 Mechanical Equipment

Type of Rate: Commercial

Change #:
LCN01-2025ib

Craft:
Pipefitter

Effective Date:
6/11/2025

Effective Date:
6/11/2025

	BHR		Fringe Benefit Payments					Irrevocable Fund		Total PWR	Overtime Rate	
			H&W	Pension	App Tr.	Vac.	Annuity	Other	LECET (*)			MISC (*)
Classification												
Pipefitter Mechanical Equipment Service A-2	\$37.51		\$13.05	\$11.80	\$1.27	\$0.00	\$3.50	\$0.20	\$0.00	\$0.00	\$67.33	\$86.09
Pipefitter Mechanical Equipment Service A-1	\$33.63		\$13.05	\$11.80	\$1.27	\$0.00	\$3.50	\$0.20	\$0.00	\$0.00	\$63.45	\$80.27
Apprentice	BHR	Percent										
1st year	\$21.09	\$56.23	\$6.11	\$0.00	\$1.27	\$0.00	\$0.00	\$0.00	\$0.00	\$0.00	\$28.47	\$39.02
2nd year	\$22.01	\$58.68	\$6.11	\$4.90	\$1.27	\$0.00	\$1.75	\$0.20	\$0.00	\$0.00	\$36.24	\$47.25
3rd year	\$24.35	\$64.92	\$6.11	\$4.90	\$1.27	\$0.00	\$1.75	\$0.20	\$0.00	\$0.00	\$38.58	\$50.76
4th year	\$28.23	\$75.26	\$6.11	\$4.90	\$1.27	\$0.00	\$1.75	\$0.20	\$0.00	\$0.00	\$42.46	\$56.58
5th year	\$30.56	\$81.47	\$6.11	\$4.90	\$1.27	\$0.00	\$1.75	\$0.20	\$0.00	\$0.00	\$44.79	\$60.07

(*)Special Calculation Note :

OTHER: SUPPLEMENTAL UNEMPLOYMENT BENEFITS

Ratio :

A per employer ratio of one (1) unindentured trainee to the first three (3) to fifteen (15) journeymen and/or apprentices shall be established, with a ratio of one (1) unindentured trainee for every fifteen (15) journeymen and/or apprentices thereafter. Each employer shall be limited to three (3) unindentured trainees. At no time shall the number of unindentured trainees exceed the number of apprentices.

Jurisdiction (* denotes special jurisdictional note) :

Ashtabula, Cuyahoga, Geauga, Lake, Medina*, Summit*

Special Jurisdictional Note :

Summit County - North of State Route 303 including work within the corporate limits of the City of Hudson, that portion of Medina County North of Route 18 and Smith Road and including work within the corporate limits of the City of Medina.

Details :

Work scope but not limited to: Mechanical Service and Maintenance work normally performed by contractors, either by contracts or emergency call basis, who are equipped to handle all work relating to evacuation, charging, start-up, inspection, operating, maintenance and service call necessary to keep mechanical system and controls of a refrigeration, air conditioning, heating and/or ventilation or any other newly installed, remodeled, revamped or redesigned mechanical system in operational order; all fire stopping and piping systems. Shall include but not limited to all maintaining, cleaning, adjusting, repairing, overhauling, starting and balancing of any system or component part thereof, regardless of size or location, including all other service and maintenance work assigned to the employer by the customer. Shall also be allowed to do the following installation work: All residential humidifiers and dehumidifiers, all window type units, all residential heating and cooling systems, excluding steam and hot water, and when a building is not new construction, all refrigeration systems up to 20 tons, split air conditioning systems up to 50 tons, and package or self-contained air conditioning units up to 50 tons.

Prevailing Wage Rate Skilled Crafts

Name of Union: Pipefitter Local 120 Sprinklerfitter

Type of Rate: Commercial

Change #:
LCN01-2025ib

Craft:
Sprinkler Fitter

Effective Date:
6/11/2025

Effective Date:
6/11/2025

	BHR		Fringe Benefit Payments						Irrevocable Fund		Total PWR	Overtime Rate
			H&W	Pension	App Tr.	Vac.	Annuity	Other	LECET (*)	MISC (*)		
Classification												
Sprinkler Fitter	\$49.17		\$13.05	\$11.80	\$1.27	\$0.00	\$3.50	\$0.20	\$0.00	\$0.00	\$78.99	\$103.58
Apprentice	BHR	Percent										
1st year	\$23.83	\$48.46	\$5.70	\$0.00	\$1.27	\$0.00	\$0.00	\$0.00	\$0.00	\$0.00	\$30.80	\$42.71
2nd year	\$24.57	\$49.97	\$12.23	\$7.20	\$1.27	\$0.00	\$0.88	\$0.20	\$0.00	\$0.00	\$46.35	\$58.64
3rd year	\$28.45	\$57.86	\$12.23	\$7.20	\$1.27	\$0.00	\$0.88	\$0.20	\$0.00	\$0.00	\$50.23	\$64.45
4th year	\$33.89	\$68.92	\$12.23	\$7.20	\$1.27	\$0.00	\$0.88	\$0.20	\$0.00	\$0.00	\$55.67	\$72.61
5th year	\$37.78	\$76.84	\$12.23	\$7.20	\$1.27	\$0.00	\$0.88	\$0.20	\$0.00	\$0.00	\$59.56	\$78.45

(*)Special Calculation Note :

OTHER: SUPPLEMENTAL UNEMPLOYMENT BENEFITS

Ratio :

1 Journeymen to 1 Apprentice 2 - 4 Journeymen to 2 Apprentices 5 - 7 Journeymen to 3 Apprentices 3 Journeymen to 1 Apprentice on jobs with 12 or more journeymen

Jurisdiction (* denotes special jurisdictional note) :

Cuyahoga, Geauga, Lake, Lorain

Special Jurisdictional Note :

Details :

Sprinklerfitter duties shall include: installation, dismantling, maintenance, repairs, adjustments and corrections of all fire protection and extinguishing systems; consist of handling and installing of all piping and appurtenances pertaining to sprinkler equipment including both overhead and underground water mains, fire hydrants and hydrants mains, stand pipes, hose connections, tank heaters, air lines, thermal systems and their connections; all operating and actuating lines and devices and their protective covering; all fire stopping of sprinkler piping systems; all tanks, pumps and city connections; fire protection systems using emulsify, spray, water fog, CO2 gas, foam and other fire control agents, settling of all fire pumps and tank filling pumps, air compressors and their connections; all work related to sprinkler inspections (included but not limited to: adjustments, maintenance, repair, testing, etc.)

Prevailing Wage Rate Skilled Crafts

Name of Union: Plasterer Local 526

Type of Rate: Commercial

Change #:
LCN01-2023ib

Craft:
Plasterer

Effective Date:
5/31/2023

Effective Date:
5/31/2023

	BHR		Fringe Benefit Payments						Irrevocable Fund		Total PWR	Overtime Rate
			H&W	Pension	App Tr.	Vac.	Annuity	Other	LECET (*)	MISC (*)		
Classification												
Plasterer	\$31.00		\$8.15	\$6.65	\$0.50	\$0.00	\$5.58	\$0.19	\$0.00	\$0.00	\$52.07	\$67.57
Apprentice	BHR	Percent										
1st Year	\$15.50	\$50.00	\$8.15	\$6.65	\$0.50	\$0.00	\$5.58	\$0.19	\$0.00	\$0.00	\$36.57	\$44.32
2nd Year	\$18.60	\$60.00	\$8.15	\$6.65	\$0.50	\$0.00	\$5.58	\$0.19	\$0.00	\$0.00	\$39.67	\$48.97
3rd Year	\$23.25	\$75.00	\$8.15	\$6.65	\$0.50	\$0.00	\$5.58	\$0.19	\$0.00	\$0.00	\$44.32	\$55.95
4th Year	\$27.90	\$90.00	\$8.15	\$6.65	\$0.50	\$0.00	\$5.58	\$0.19	\$0.00	\$0.00	\$48.97	\$62.92

(*)Special Calculation Note :

Other is for Substance abuse and training.

Ratio :

1 Journeymen to 1 Apprentice 3 Journeymen to 1 Apprentice.

Jurisdiction (* denotes special jurisdictional note) :

Ashtabula, Cuyahoga, Geauga, Lake, Lorain

Special Jurisdictional Note :

Details :

Prevailing Wage Rate Skilled Crafts

Name of Union: Plumber Local 55

Type of Rate: Commercial

Change #:
LCN01-2025ib

Craft:
Plumber

Effective Date:
5/21/2025

Effective Date:
5/21/2025

Classification	BHR		Fringe Benefit Payments					Irrevocable Fund		Total PWR	Overtime Rate	
			H&W	Pension	App Tr.	Vac.	Annuity	Other	LECET (*)			MISC (*)
Plumber	\$44.86		\$12.87	\$9.63	\$1.23	\$0.00	\$7.10	\$0.20	\$0.00	\$0.00	\$75.89	\$98.32
Shopman (When in the field)	\$24.69		\$9.50	\$5.59	\$0.10	\$0.00	\$3.85	\$0.00	\$0.00	\$0.00	\$43.73	\$56.08
Plumber Light Commercial Journeymen	\$29.42		\$9.18	\$2.28	\$0.69	\$0.00	\$3.58	\$0.20	\$0.00	\$0.00	\$45.35	\$60.06
Apprentice Light Commercial Trainee	\$		\$	\$	\$	\$	\$	\$	\$	\$	\$	\$
0-3 Months	\$14.84		\$0.00	\$0.00	\$0.50	\$0.00	\$0.00	\$0.00	\$0.00	\$0.00	\$15.34	\$22.76
4-6 Months	\$15.03		\$3.69	\$0.00	\$0.46	\$0.00	\$0.00	\$0.00	\$0.00	\$0.00	\$19.18	\$26.70
7-12 Months	\$15.32		\$4.42	\$0.33	\$0.63	\$0.00	\$1.13	\$0.00	\$0.00	\$0.00	\$21.83	\$29.49
2nd Year	\$16.67		\$4.49	\$0.35	\$0.65	\$0.00	\$1.20	\$0.00	\$0.00	\$0.00	\$23.36	\$31.70
3rd Year	\$18.03		\$4.55	\$0.36	\$0.68	\$0.00	\$1.28	\$0.00	\$0.00	\$0.00	\$24.90	\$33.92
Apprentice	BHR	Percent										
1-6 Months	\$19.80	\$44.14	\$7.39	\$0.24	\$0.95	\$0.00	\$1.56	\$0.00	\$0.00	\$0.00	\$29.94	\$39.84
7-12 Months	\$22.50	\$50.15	\$7.61	\$0.44	\$1.00	\$0.00	\$2.01	\$0.20	\$0.00	\$0.00	\$33.76	\$45.01
2nd year 1-6	\$24.07	\$53.65	\$8.37	\$0.85	\$1.05	\$0.00	\$3.06	\$0.20	\$0.00	\$0.00	\$37.60	\$49.63
2nd year 7-12	\$25.01	\$55.76	\$8.55	\$2.85	\$1.05	\$0.00	\$3.78	\$0.20	\$0.00	\$0.00	\$41.44	\$53.95
3rd year 1-6	\$28.09	\$62.61	\$9.08	\$2.80	\$1.05	\$0.00	\$4.00	\$0.20	\$0.00	\$0.00	\$45.22	\$59.26
3rd year 7-12	\$30.24	\$67.40	\$9.32	\$3.63	\$1.05	\$0.00	\$4.62	\$0.20	\$0.00	\$0.00	\$49.06	\$64.17
4th year	\$33.02	\$73.60	\$9.57	\$4.07	\$1.05	\$0.00	\$4.98	\$0.20	\$0.00	\$0.00	\$52.89	\$69.40
5th year	\$35.83	\$79.88	\$9.81	\$4.51	\$1.05	\$0.00	\$5.33	\$0.20	\$0.00	\$0.00	\$56.73	\$74.65

(*)Special Calculation Note :

OTHER IS: SUPPLEMENTAL UNEMPLOYMENT

Ratio :

1 Journeyman 1 Apprentice 2 Journeymen to 1 Apprentice thereafter Light Commercial Ratio 1-2 Journeymen to 1 Trainee 3 Journeymen to 2 Trainees 4-5 Journeymen to 3 Trainees 6-8 Journeymen to 4 Trainees 9-10 Journeymen to 5 Trainees 11-13 Journeymen to 6 Trainees

Jurisdiction (* denotes special jurisdictional note) :

Ashtabula, Cuyahoga, Geauga, Lake, Medina*, Summit*

Special Jurisdictional Note :

Summit County - North of State Route 303 including work within the corporate limits of the City of Hudson, that portion of Medina County North of Route 18 and Smith Road and the corporate limits of the City of Medina.

Details :

The Plumber Shopman will have charge of the Employer's shop and warehouse containing plumbing and heating supplies and equipment, and perform such duties as are customarily required by a Plumber or a Plumber's Shopman, including casual delivery of tools and equipment necessary for installation of Plumbing and Heating facilities. One field shopman per shop may be hired after employing the 1st apprentice, and a second field shopman per shop may be hired after employing the 5th apprentice. These shopmen may work in the field performing primarily non-mechanical work. The plumber shopman's duties do not include the installation of plumbing. The Plumber Light Commercial Rate can be used for the following: Any private construction project covered by this agreement shall be eligible for designation as a Market Recovery Project (Lt Commercial). The Market Recovery (Lt Commercial) wage rate shall be determined project specific by the business manager. The Market Recovery rate (Lt Commercial) may be utilized on all new, repair, remodeling, alteration, and/or maintenance (interior and exterior) of "Private Enterprise Projects"; including office buildings, service buildings, retail establishments, churches, motels/hotels, and strip shopping centers which fall under this agreement.

Prevailing Wage Rate Skilled Crafts

Name of Union: Roofer Local 44

Type of Rate: Commercial

Change #: LCN01-2025ib

Craft: Roofer

Effective Date: 5/21/2025

Effective Date: 5/21/2025

Classification	BHR		Fringe Benefit Payments					Irrevocable Fund		Total PWR	Overtime Rate	
			H&W	Pension	App Tr.	Vac.	Annuity	Other	LECET (*)			MISC (*)
Roofer	\$40.15		\$9.64	\$11.15	\$0.49	\$0.00	\$0.00	\$0.06	\$0.00	\$0.00	\$61.49	\$81.57
Applicant & Helper Trainees	\$		\$	\$	\$	\$	\$	\$	\$	\$	\$	\$
0 to 1851 hrs	\$18.07		\$0.60	\$0.50	\$0.49	\$0.00	\$0.00	\$0.06	\$0.00	\$0.00	\$19.72	\$28.76
1852 to 3350 hrs	\$22.08		\$9.64	\$11.15	\$0.49	\$0.00	\$0.00	\$0.06	\$0.00	\$0.00	\$43.42	\$54.46
3351 to 4850 hrs	\$28.11		\$9.64	\$11.15	\$0.49	\$0.00	\$0.00	\$0.06	\$0.00	\$0.00	\$49.45	\$63.51
4851 to 6350 hrs	\$31.12		\$9.64	\$11.15	\$0.49	\$0.00	\$0.00	\$0.06	\$0.00	\$0.00	\$52.46	\$68.02
6351 to 7550 hrs	\$36.14		\$9.64	\$11.15	\$0.49	\$0.00	\$0.00	\$0.06	\$0.00	\$0.00	\$57.48	\$75.55
7551 hrs	\$40.15		\$9.64	\$11.15	\$0.49	\$0.00	\$0.00	\$0.06	\$0.00	\$0.00	\$61.49	\$81.57
Apprentice	BHR	Percent										
Start of school	\$20.08	\$50.02	\$0.60	\$0.50	\$0.49	\$0.00	\$0.00	\$0.06	\$0.00	\$0.00	\$21.73	\$31.77
600 hrs worked/72 school hrs	\$22.08	\$55.00	\$0.60	\$0.50	\$0.49	\$0.00	\$0.00	\$0.06	\$0.00	\$0.00	\$23.73	\$34.77
1200 hrs worked/144 school hrs	\$24.09	\$60.00	\$9.64	\$11.15	\$0.49	\$0.00	\$0.00	\$0.06	\$0.00	\$0.00	\$45.43	\$57.48
1800 hrs worked/216 school hrs	\$26.10	\$65.00	\$9.64	\$11.15	\$0.49	\$0.00	\$0.00	\$0.06	\$0.00	\$0.00	\$47.44	\$60.49
2400 hrs worked/288 school hrs	\$28.11	\$70.02	\$9.64	\$11.15	\$0.49	\$0.00	\$0.00	\$0.06	\$0.00	\$0.00	\$49.45	\$63.51
3000 hrs worked/360 school hrs	\$30.11	\$75.00	\$9.64	\$11.15	\$0.49	\$0.00	\$0.00	\$0.06	\$0.00	\$0.00	\$51.45	\$66.51
3600 hrs worked/432 school hrs	\$32.12	\$80.00	\$9.64	\$11.15	\$0.49	\$0.00	\$0.00	\$0.06	\$0.00	\$0.00	\$53.46	\$69.52
4200 hrs worked/504 school hrs	\$36.14	\$90.02	\$9.64	\$11.15	\$0.49	\$0.00	\$0.00	\$0.06	\$0.00	\$0.00	\$57.48	\$75.55
4800 hrs/576 school hrs	\$40.15	\$100.00	\$9.64	\$11.15	\$0.49	\$0.00	\$0.00	\$0.06	\$0.00	\$0.00	\$61.49	\$81.57

(*)Special Calculation Note :

Other is for Drug Testing.

Ratio :

2 Journeymen to 1 Apprentice 1 Applicant/Helper Trainee

Jurisdiction (* denotes special jurisdictional note) :

Ashtabula, Cuyahoga, Erie, Geauga, Lake, Lorain*, Sandusky

Special Jurisdictional Note :

Lorain (The Ohio Turnpike North)

Details :

Prevailing Wage Rate Skilled Crafts

Name of Union: Sheet Metal Local 33 (Cleveland)

Type of Rate: Commercial

Change #:
LCN01-2025ib

Craft:
Sheet Metal Worker

Effective Date:
8/20/2025

Effective Date:
8/20/2025

	BHR		Fringe Benefit Payments					Irrevocable Fund		Total PWR	Overtime Rate	
			H&W	Pension	App Tr.	Vac.	Annuity	Other	LECET (*)			MISC (*)
Classification												
Sheet Metal Worker	\$44.42		\$9.39	\$17.88	\$0.96	\$0.00	\$3.08	\$0.00	\$0.00	\$0.00	\$75.73	\$97.94
Apprentice	BHR	Percent										
1st year	\$22.21	\$50.00	\$9.39	\$3.15	\$0.20	\$0.00	\$0.00	\$0.00	\$0.00	\$0.00	\$34.95	\$46.05
2nd year	\$24.41	\$54.95	\$9.39	\$3.47	\$0.96	\$0.00	\$3.08	\$0.00	\$0.00	\$0.00	\$41.31	\$53.52
3rd year	\$26.63	\$59.96	\$9.39	\$3.78	\$0.96	\$0.00	\$3.08	\$0.00	\$0.00	\$0.00	\$43.84	\$57.16
4th year	\$33.30	\$74.96	\$9.39	\$4.73	\$0.96	\$0.00	\$3.08	\$0.00	\$0.00	\$0.00	\$51.46	\$68.11

(*)Special Calculation Note :

Ratio :

- 1 Journeyman to 1 Apprentice
- 2 Journeymen to 2 Apprentices
- 3-6 Journeymen to 3 Apprentices
- 7-8 Journeymen to 4 Apprentices
- 9-10 Journeymen to 5 Apprentices
- 11-12 Journeymen to 6 Apprentices
- 13-14 Journeymen to 7 Apprentices
- 15-16 Journeymen to 8 Apprentices
- 17-18 Journeymen to 9 Apprentices
- 19-20 Journeymen to 10 Apprentices

Jurisdiction (* denotes special jurisdictional note) :

Ashtabula, Cuyahoga, Geauga, Lake

Special Jurisdictional Note :

Details :

Prevailing Wage Rate Skilled Crafts

Name of Union: Sheet Metal Local 33 Industrial Door

Type of Rate: Commercial

Change #:
LCN01-2025ib

Craft:
Sheet Metal Worker

Effective Date:
8/1/2025

Effective Date:
8/1/2025

Classification	BHR		Fringe Benefit Payments						Irrevocable Fund		Total PWR	Overtime Rate
			H&W	Pension	App Tr.	Vac.	Annuity	Other	LECET (*)	MISC (*)		
Sheet Metal Worker	\$26.53		\$8.71	\$5.66	\$0.19	\$0.00	\$2.61	\$0.61	\$0.00	\$0.00	\$44.31	\$57.58
Apprentice	BHR	Percent										
Probationary Period (60 Days)	\$13.80	\$52.00	\$0.00	\$0.00	\$0.00	\$0.00	\$0.00	\$0.00	\$0.00	\$0.00	\$13.80	\$20.70
61st day -12 months	\$15.39	\$58.00	\$8.71	\$1.96	\$0.19	\$0.00	\$1.68	\$0.35	\$0.00	\$0.00	\$28.28	\$35.98
2nd Year	\$18.04	\$68.00	\$8.71	\$1.96	\$0.19	\$0.00	\$1.90	\$0.41	\$0.00	\$0.00	\$31.21	\$40.23
3rd Year	\$19.37	\$73.00	\$8.71	\$1.96	\$0.19	\$0.00	\$2.05	\$0.45	\$0.00	\$0.00	\$32.73	\$42.41
4th Year	\$21.22	\$80.00	\$8.71	\$1.96	\$0.19	\$0.00	\$2.17	\$0.49	\$0.00	\$0.00	\$34.74	\$45.35
5th Year	\$22.82	\$86.00	\$8.71	\$1.96	\$0.19	\$0.00	\$2.31	\$0.52	\$0.00	\$0.00	\$36.51	\$47.92

(*)Special Calculation Note :

Other: Holiday Pay

Ratio :

- 1-2 Journeyman to 1 Trainee
- 3-4 Journeymen to 2 Trainee
- 5-6 Journeymen to 3 Trainees
- 7-8 Journeymen to 4 Trainees
- 9-10 Journeymen to 5 Trainees
- 11-13 Journeymen to 6 Trainees
- 14-16 Journeymen to 7 Trainees
- 17-19 Journeymen to 8 Trainees
- Maintaining a 3 Journeymen to 1 Trainee ratio thereafter

Jurisdiction (* denotes special jurisdictional note) :

Ashland, Ashtabula, Carroll, Columbiana, Coshocton, Crawford, Cuyahoga, Defiance, Erie, Fulton, Geauga, Hancock, Henry, Holmes, Huron, Lake, Lorain, Lucas, Mahoning, Medina, Ottawa, Paulding, Portage, Putnam, Richland, Sandusky, Seneca, Stark, Summit, Trumbull, Tuscarawas, Wayne, Williams, Wood

Special Jurisdictional Note :

Details :

Prevailing Wage Rate Skilled Crafts

Name of Union: Truck Driver Local 436 - HevHwy Class 1

Type of Rate: Commercial

Change #:
LCN02-2025ib

Craft:
Truck Driver

Effective Date:
5/28/2025

Effective Date:
5/28/2025

	BHR		Fringe Benefit Payments					Irrevocable Fund		Total PWR	Overtime Rate	
			H&W	Pension	App Tr.	Vac.	Annuity	Other	LECET (*)			MISC (*)
Classification												
Truck Driver CLASS 1	\$34.92		\$9.25	\$10.05	\$0.40	\$0.00	\$0.00	\$0.00	\$0.00	\$0.00	\$54.62	\$72.08
Apprentice	BHR	Percent										
First 6 months	\$27.94	\$80.00	\$9.25	\$10.05	\$0.40	\$0.00	\$0.00	\$0.00	\$0.00	\$0.00	\$47.64	\$61.60
7-12 months	\$29.68	\$85.00	\$9.25	\$10.05	\$0.40	\$0.00	\$0.00	\$0.00	\$0.00	\$0.00	\$49.38	\$64.22
13-18 months	\$31.43	\$90.00	\$9.25	\$10.05	\$0.40	\$0.00	\$0.00	\$0.00	\$0.00	\$0.00	\$51.13	\$66.84
19-24 months	\$33.17	\$95.00	\$9.25	\$10.05	\$0.40	\$0.00	\$0.00	\$0.00	\$0.00	\$0.00	\$52.87	\$69.46
25-30 months	\$34.92	\$100.00	\$9.25	\$10.05	\$0.40	\$0.00	\$0.00	\$0.00	\$0.00	\$0.00	\$54.62	\$72.08

(*)Special Calculation Note :

Ratio :

3 Journeymen to 1 Apprentice

Jurisdiction (* denotes special jurisdictional note) :

Cuyahoga, Geauga, Lake

Special Jurisdictional Note :

Details :

CLASS 1: Drivers on trucks, including but not limited to: 4-wheel service trucks; 4-wheel dump trucks; batch trucks; drivers on tandems; truck sweepers (not to include power sweepers and scrubbers) Drivers on tractor – trailer combinations including but not limited to the following: Semi-tractor trucks; pole trailers; ready-mix trucks; fuel trucks; all trucks five (5) axle and over; drivers on belly dumps; truck mechanics (when needed).

Prevailing Wage Rate Skilled Crafts

Name of Union: Truck Driver Local 436 - HevHwy Class 2

Type of Rate: Commercial

Change #:
LCN02-2025ib

Craft:
Truck Driver

Effective Date:
5/28/2025

Effective Date:
5/28/2025

	BHR		Fringe Benefit Payments						Irrevocable Fund		Total PWR	Overtime Rate
			H&W	Pension	App Tr.	Vac.	Annuity	Other	LECET (*)	MISC (*)		
Classification												
Truck Driver CLASS 2	\$35.73		\$9.25	\$10.05	\$0.40	\$0.00	\$0.00	\$0.00	\$0.00	\$0.00	\$55.43	\$73.30
Apprentice	BHR	Percent										
First 6 months	\$28.58	\$80.00	\$9.25	\$10.05	\$0.40	\$0.00	\$0.00	\$0.00	\$0.00	\$0.00	\$48.28	\$62.58
7-12 months	\$30.37	\$85.00	\$9.25	\$10.05	\$0.40	\$0.00	\$0.00	\$0.00	\$0.00	\$0.00	\$50.07	\$65.26
13-18 months	\$32.16	\$90.00	\$9.25	\$10.05	\$0.40	\$0.00	\$0.00	\$0.00	\$0.00	\$0.00	\$51.86	\$67.94
19-24 months	\$33.94	\$95.00	\$9.25	\$10.05	\$0.40	\$0.00	\$0.00	\$0.00	\$0.00	\$0.00	\$53.64	\$70.62
25-30 months	\$35.73	\$100.00	\$9.25	\$10.05	\$0.40	\$0.00	\$0.00	\$0.00	\$0.00	\$0.00	\$55.43	\$73.30

(*)Special Calculation Note :

Ratio :

3 Journeymen to 1 Apprentice

Jurisdiction (* denotes special jurisdictional note) :

Cuyahoga, Geauga, Lake

Special Jurisdictional Note :

Details :

CLASS 2: Drivers on articulated dump trucks; rigid-frame rock trucks; distributor trucks; low boys/drag driver on the construction site only and heavy duty equipment (irrespective of load carried) when used exclusively for transportation on the construction site only.